

Chapter SPS 390

APPENDIX

The material contained in this appendix is for clarification purposes only. The notes, illustrations, etc., are numbered to correspond to the number of the rule as it appears in the text of the code.

A-390.03 (26) Plan submittal and fees. The following is a listing of when the department may waive submittal of pool plans and fees for the reconstruction and alteration of existing pools.

1. A disinfection system equipped with a positive displacement pump is replaced by an approved pass-through (erosion) type system^a or vice versa, the replacement of a gas chlorine system with a positive displacement pump or approved pass-through feeder^a.

Note: The installation of a gas chlorine system will require plan submittal and a fee.

2. A circulation pump is replaced by another pump from a different manufacturer provided that the new pump is the same make and model or equivalent^a.
3. A filter is replaced with an approved filter of the same make and model or equivalent^a.
4. The replacement of metal piping and fittings with the same size PVC piping and fittings used to repair a small section of the circulation system (less than 10 feet).
5. A supplemental disinfecting system^a is installed (e.g., Ozone, Ultraviolet Light, etc.) provided that the halogen residual is maintained as stated in ch. DHS 172 and that there is no decrease in the required water circulation flow rate.
6. For the installation of a slide 6-foot or less in height, a slide structural plan review in accordance with ch. SPS 361 is not required. Such slides shall meet the guidelines listed in Table 390.30-1.
7. Minor repair of basin or deck.

^a All equipment under the scope of NSF 50 must be listed to comply with NSF 50.

A-390.05 (2) Authorized inspection agents. In addition to department staff, the department has authorized representatives to conduct inspections of construction or modification of any public swimming pool or water attraction that require approval under s. SPS 390.04. The cities of Madison, Milwaukee and Racine do inspections for those installations located within their jurisdiction.

Note: The Department maintains a list on the Division of Industry Services Web page at <http://dsps.wi.gov/programs/industry-services> that is subject to change.

A-390.11 (8) Measuring the transitional radius between the wall and floor of a basin in less than 5 feet of water.

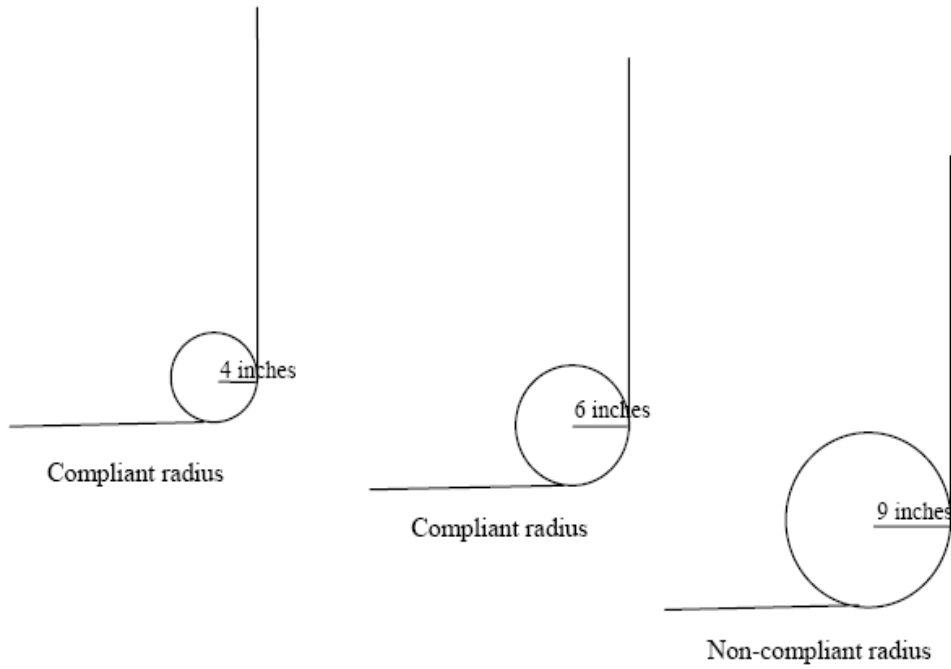

A-390.11 (10) Design of the vanishing edge basin.

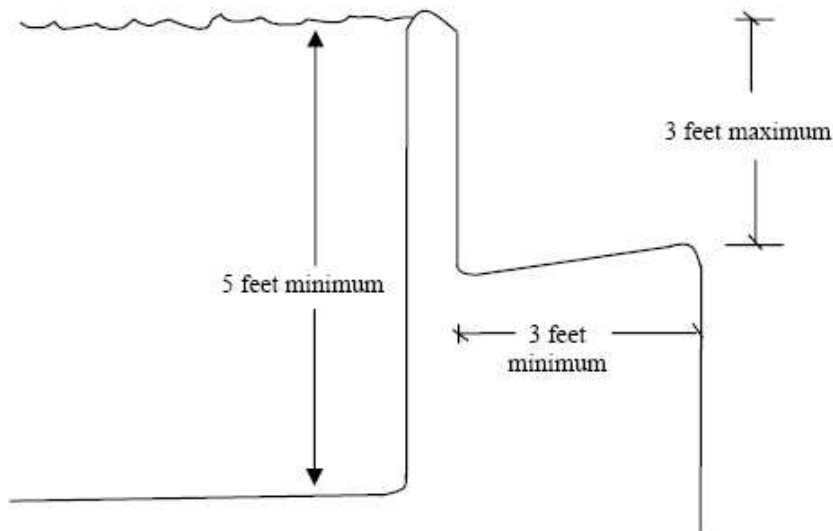

A-390.12 (3) Deck-mounted hand-rail installations.

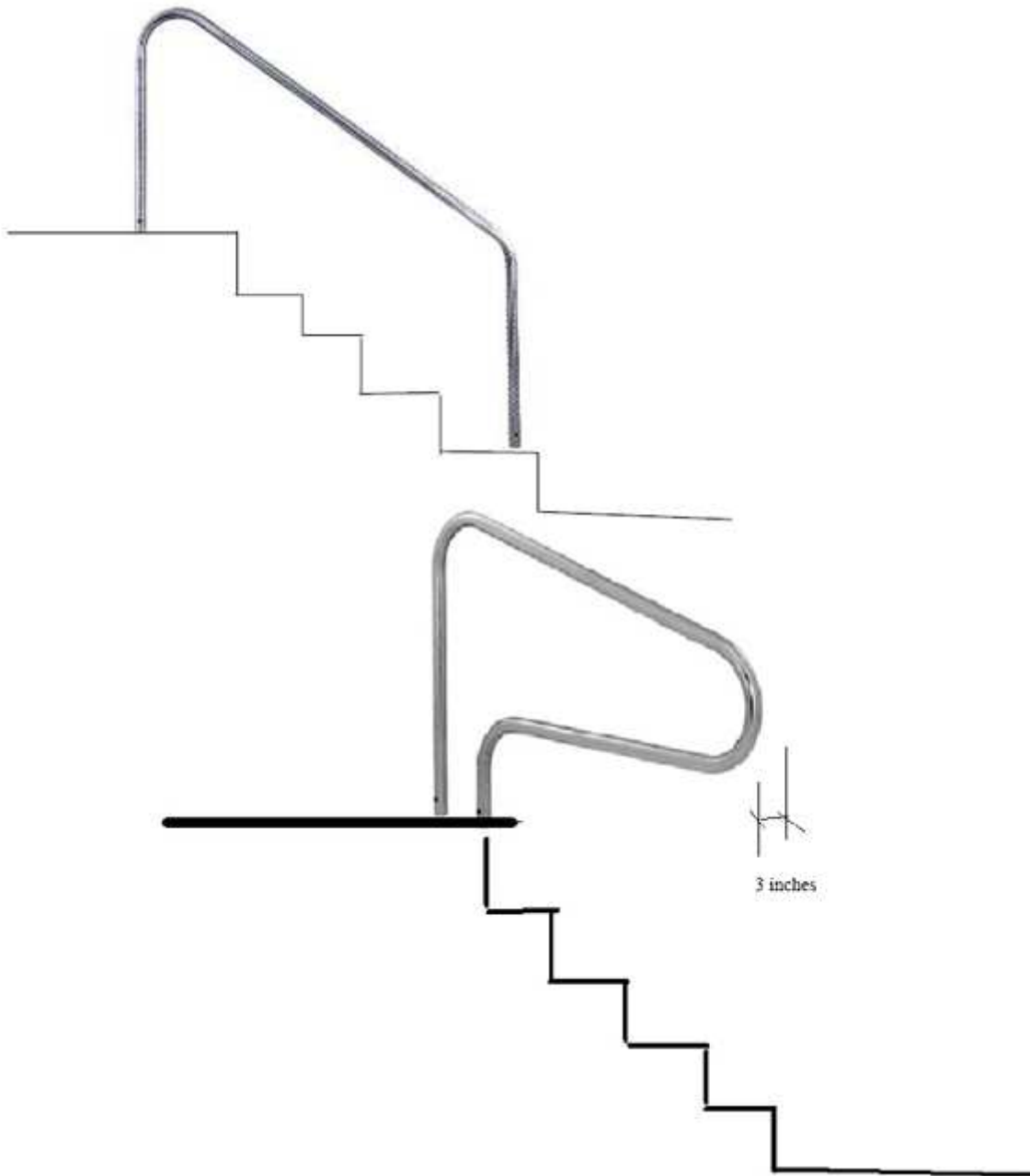

A-390.13 (5) Outdoor pool deck drain storm sewer connection.

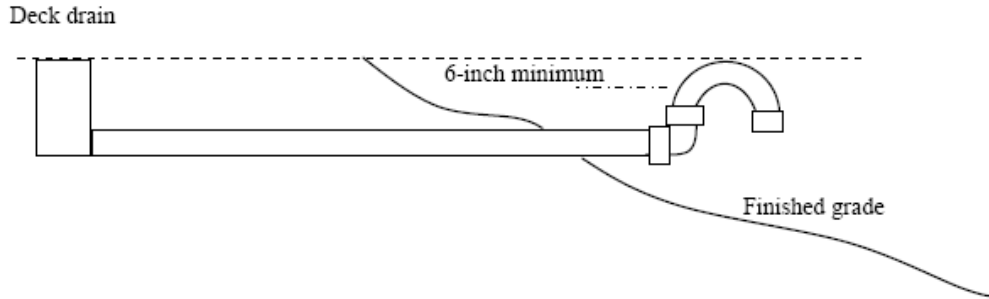

Deck drain – Elevation 100.0 feet

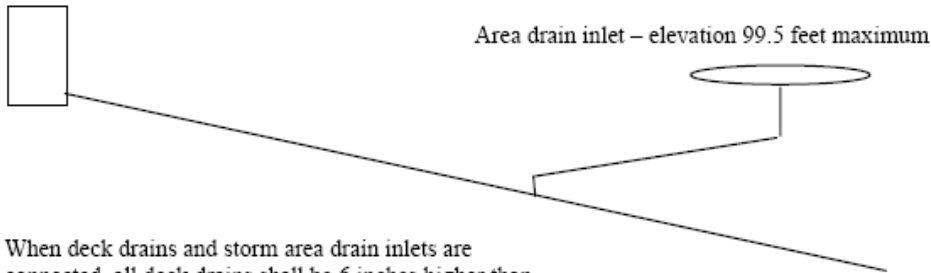

When deck drains and storm area drain inlets are connected, all deck drains shall be 6 inches higher than storm area drain inlets. It must be demonstrated that regardless of the location of any clogged drain, wastewater would discharge from the area drain inlet before ponding on the deck of the pool.

A-390.14 (1) Turnover rate calculation for water slides.

Imaginary Plunge Pool (IPP) = 6,700 gallons that requires one turnover recirculation.

(15 ft X 20 ft X 3 ft = 900 cu ft = 6,700 gallons)

The concept of the imaginary plunge pool is applied to a single waterslide or runout slide that is associated with a pool and uses water from the associated pool for its operation. When more than one waterslide or runout slide is associated with a pool, each additional runout slide or waterslide contributes 4,500 gallons to the imaginary plunge pool quantity of water.

(10 ft X 20 ft X 3 ft = 600 cu ft = 4,500 gallons)

Calculation examples using the IPP concept:

1. Addition of one waterslide or runout slide to a 70,000 gallon pool

70,000 gal pool =	6,700 gal 1hr IPP + 63,300 gal 6hr pool
6,700 gal ÷ 60 min =	112 gpm recirculation
63,300 gal ÷ 360 min =	<u>176</u> gpm recirculation
	288 gpm total recirculation requirement
70,000 gal ÷ 288 gpm =	4 hr turnover for addition of one waterslide or runout slide

2. Addition of one waterslide or runout slide to a 170,000 gallon pool

170,000 gal pool =	6,700 gal 1hr IPP + 163,300 gal 6hr pool
6,700 gal ÷ 60 min =	112 gpm recirculation
163,300 gal ÷ 360 min =	<u>454</u> gpm recirculation
	566 gpm total recirculation requirement
170,000 gal ÷ 566 gpm =	5 hr turnover for addition of one waterslide or runout slide

3. Addition of two waterslides or runout slides to a 170,000 gallon pool

170,000 gal pool =	11,200 gal 1hr IPP + 158,800 gal 6hr pool
11,200 gal ÷ 60 min =	187 gpm recirculation
158,800 gal ÷ 360 min =	<u>441</u> gpm recirculation
	628 gpm total recirculation requirement
170,000 gal ÷ 628 gpm =	4.5 hr turnover for addition of one waterslide or runout slide

A-390.14 (13) Flows carried by inlets.

Inlet Sizes (In inches)	Flow Through Inlets (In gallons per minute)		
	5fps	10fps	20fps
3/8	1.72	3.44	6.89
1/2	3.06	6.12	12.24
5/8	4.78	9.56	19.13
3/4	6.88	13.77	27.55
7/8	9.37	18.74	37.49
1	12.24	24.48	48.97
1-1/4	19.12	38.25	76.53
1-1/2	27.54	55.08	110.19
2	48.96	97.91	195.91

A-390.14 (13) Influence of radius illustrated.

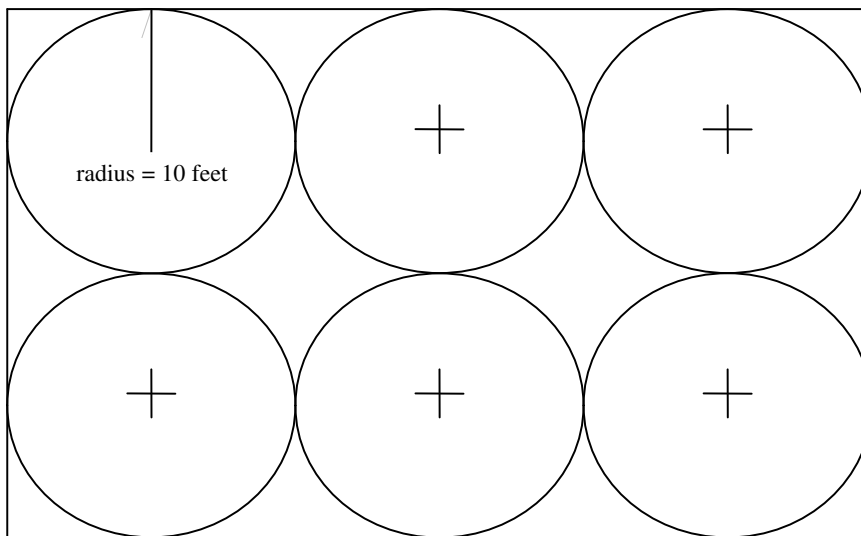

A-390.16 (4) Water quality requirements.

**Table 382.70-1
(Partial)
Plumbing Treatment Standards**

Intended Use	Plumbing Treatment Standards ^f
4. Swimming pool makeup water	NR 811 and 812 approved sources
5. Swimming pool fill water	DHS 172 requirements

^f For stormwater, the plumbing treatment standards are based on an annual average. Evaluation of research to prove compliance with this table is based on the geometric mean of the data acceptable to the department or an equivalent method.

A–390.16 (5) Wastewater discharge points and requirements.

SPS 382.33 (9) (k)

(k) *Swimming pools.* 1. The backwash and drain wastewater from a swimming pool, wading pool or whirlpool shall discharge in accordance with Table 382.38–1.

2. The discharge from deck drains serving indoor pools shall be directed to the sanitary sewer via an air–gap.

3. The discharge from deck drains serving outdoor pools shall be directed to the storm sewer by way of an air–gap or to grade.

4. The requirements for sewer connections as specified in ch. SPS 390 applies to all public swimming pools.

Note: An alternate system approval exists to allow backwash discharge via air break.

**Table 382.38–1
(Partial)
Allowable Discharge Points by Fixture or Specific Use**

Use or Fixture	Allowable Discharge Points					
	POWTS ^a	Municipal Sanitary Sewer	Municipal Storm Sewer	Ground Surface	Combined Sanitary–Storm Sewer	Subsurface Dispersal ⁱ
11. Stormwater, groundwater, fire sprinkler test discharge and clear water	X	X ^g	X ^c	X ^b	X	X
13. Swimming pool or wading pool – diatomaceous earth filter backwash	X	X			X	
14. Swimming pool or wading pool – drain wastewater	X	X ^b	X ^{b,c}	X ^{b,c}	X ^b	X
15. Swimming pool or wading pool – sand filter backwash	X	X ^b	X ^{b,c}	X ^{b,c}	X ^b	X
18. Whirlpool backwash drain and wastewater	X	X	X ^c	X ^{b,c}	X	

a Allowed when the POWTS is designed to include designated wastewater.

b Unless prohibited by local municipality and when no nuisance is created.

c A discharge permit may be required by the department of natural resources.

g Fifty gallons per day.

i Subsurface dispersal must comply with s. SPS 382.365.

A-390.20 Filling options for wading pools and whirlpools from other basins using a 3-way valve.

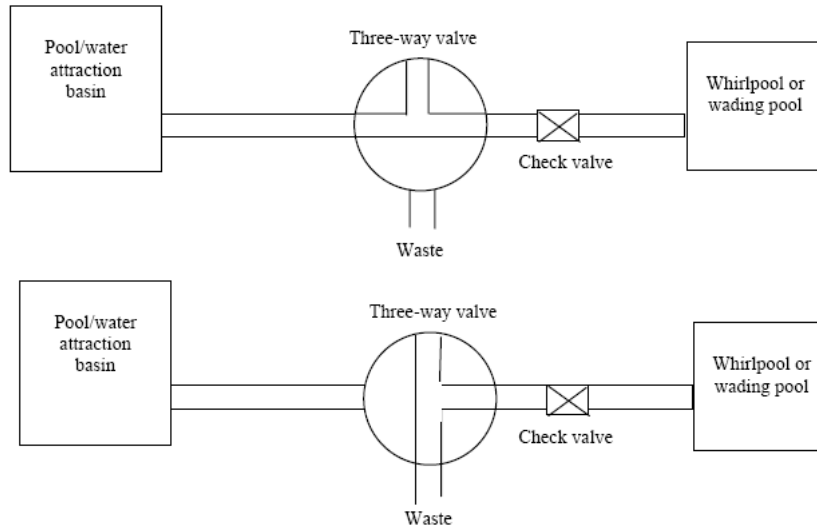

A-390.31 (3) Children's slide obstructions in wading pools.

The square footage of the obstruction between the water level to a height of 6 feet for the obstruction shown is 48 square feet. This obstruction is code compliant without a lifeguard staffing plan.

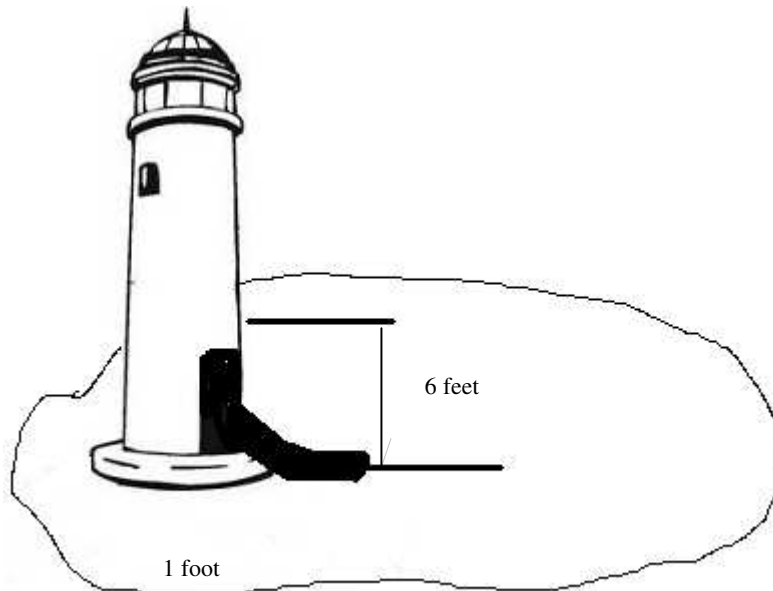

In the drawing above, the obstructed area between the water level to height of 6 feet is 3 square feet. This obstruction would be permitted in a wading pool without a lifeguard plan.