

## Chapter DHS 163

### APPENDIX B

---

#### HUD Guidelines for the Evaluation and Control of Lead–Based Paint Hazards in Housing

---

#### Step–by–Step Summary Interim Control: How To Do It

1. Owners of properties in good condition may decide to proceed directly to interim control without a risk assessment. This involves stabilizing any deteriorated paint (see Section II), on the assumption that all deteriorated paint contains lead–based paint, thoroughly cleaning all surfaces (see Section IV), and covering all bare soil (see Section V). These measures should be followed by a risk assessment (not a risk assessment screen) to determine if the property meets clearance standards and if any hazards were left uncorrected. All interim control activities should be carried out in accordance with the procedures described in these *Guidelines*.
2. Alternatively, an owner may first have an independent risk assessment performed by a certified professional to determine if lead–based paint hazards exist and to minimize hazard control activities.
3. Together with a certified risk assessor, planner, or other designer, develop a site–specific lead hazard control plan based on the hazards identified, the feasibility of the control measures, occupant protection, and financing. For interim controls and some abatement techniques, the plan should include how and when ongoing monitoring by the owner and reevaluation by a certified risk assessor or certified inspector will be performed. (See Chapter 6 for standard reevaluation schedules).
4. For building components, determine which hazards will be addressed with interim controls (dust removal, paint stabilization, and/or control of friction/abrasion points). For lead–contaminated soil, decide which interim control measure is appropriate for the climate and the planned use of the area.
5. Develop specifications (if appropriate). The amount of detail provided should be commensurate with the size of the job. The specifications should state how any abatement activities and other construction work (e.g., weatherization) will coincide with the interim control work. It may be preferable to combine interim controls with abatement in many cases.
6. Although interim controls are not expected to generate hazardous waste, the planner or risk assessor should make this assessment for each project and notify local authorities if the local jurisdiction requires it.
7. Select a qualified, trained contractor to complete the hazard control work. For some small jobs, onsite maintenance workers may be able to perform the work. In either case, Occupational Safety and Health Administration (OSHA) regulations require all interim control workers to be trained.
8. Select the appropriate interior and/or exterior Worksite Preparation Level (from Chapter 8) to protect residents.
9. Notify residents of the dwelling and nearby dwellings of the work and when it will begin. Distribute educational materials furnished by the U.S. Environmental Protection Agency (EPA) and/or the State or local government to residents about lead poisoning and lead–safe practices.
10. Correct any existing conditions that could undermine the success of the interim controls (e.g., structural deficiencies, moisture problems, uncleanable surfaces).
11. For exterior work, preinterim control soil samples should be collected but not necessarily analyzed until clearance soil samples have been collected, analyzed, and compared to clearance standards. If soil levels are below applicable limits, the baseline samples need not be analyzed (see Chapter 15).

12. Execute interim control work. See the Step-by-Step Summaries in each section of this chapter for information about dust removal, paint film stabilization, friction and impact surface treatments, and interim soil controls.
13. Store all waste in a secure area and make sure that it is properly labeled (see Chapter 10). Dispose of all waste properly.
14. Conduct daily and final cleanups (see Chapter 14).
15. Have an independent, certified inspector technician or risk assessor conduct a clearance examination 1 hour after cleanup to let dust settle (see Chapter 15). If no preliminary risk assessment was performed, only a certified risk assessor can conduct the clearance examination/risk assessment. If clearance is not achieved, complete interim controls and/or reclean. Following a successful clearance examination, the property owner should receive documentation to that effect, including a schedule for required reevaluation (if applicable). Local authorities may also require a Statement of Lead-Based Paint Compliance.
16. Pay contractor and clearance examiner.
17. The owner should conduct ongoing maintenance and monitoring of interim controls to ensure that they remain in place. Periodic reevaluations by a certified risk assessor should be completed according to the reevaluation schedule in the hazard control plan of the property.
18. Maintain records of all lead hazard control, reevaluation, and monitoring activities and turn them over to any new owner upon sale of the property.

## Chapter 11: Interim Controls

### Section I

#### I. Principles of Interim Control

##### A. Introduction

While interim controls have been carried out in some public housing developments under the name of “in-place management,” the concept is relatively new in the field of lead hazard control. Interim controls are intended to make dwellings lead-safe by temporarily controlling lead-based paint hazards, as opposed to abatement, which is intended to permanently control lead hazards. See Chapter 12 for a more detailed discussion of the difference between abatement and interim controls. In Title X of the Housing and Community Development Act of 1992, interim controls are defined as “. . . a set of measures designed to reduce temporarily human exposure or likely exposure to lead-based paint hazards, including specialized cleaning, repairs, maintenance, painting, temporary containment, ongoing monitoring of lead-based paint hazards or potential hazards and the establishment and operation of management and resident education programs.” Interim control measures are fully effective only as long as they are carefully monitored, maintained, and periodically professionally reevaluated. If interim controls are properly maintained, they can be effective indefinitely. As long as surfaces are covered with lead-based paint, however, they constitute potential hazards.

Basic elements include planning, implementation of interim controls, cleanup and clearance, education of residents and maintenance staff, ongoing maintenance and monitoring by the owner, and periodic reevaluation by a certified professional. The term “certified professional” means a certified risk assessor or certified inspector.

Interim lead hazard control measures include:

- \* Repairing all rotted or defective substrates that could lead to rapid paint deterioration (repairing defective building systems that cause substrate damage may be a prerequisite for effective interim control but is outside the scope of interim control per se).
- \* Paint film stabilization (see Section II)—stabilizing all deteriorated lead-based paint surfaces by removing deteriorating paint and repainting.
- \* Friction and impact surface treatments (see Section III)—treating floors and interior window sills and window troughs so that they are smooth and cleanable.
- \* Treating friction and impact surfaces, such as windows, doors, stair treads, and floors, when they are

generating lead-based paint chips or excessive levels of leaded dust that cannot be controlled with ordinary cleaning.

- \* Treating protruding, accessible surfaces, such as interior window sills, where lead-based paint may be present and there is either visual or reported evidence that children are mouthing or chewing them.
- \* Treating all bare soil containing excessive levels of lead.
- \* Dust removal and control (see Section IV)—cleaning surfaces to reduce levels of leaded dust to acceptable levels, including cleaning carpets, if they are contaminated.
- \* Educating residents and maintenance workers on how to avoid lead poisoning.
- \* Conducting reevaluations by certified individuals, ongoing monitoring by owners, and observation by residents.

After completion of lead hazard control measures, an independent, certified inspector technician or risk assessor should carry out a clearance examination, which includes a visual inspection to determine whether all necessary lead hazard control measures were completed and collecting dust samples to determine whether floors, interior window sills, and window troughs meet clearance levels.

The property owner should implement an active maintenance regime to ensure that the property continues to be free of hazards. Such a maintenance regime should consider the likelihood that leaded dust may be tracked into the housing unit from the outside. Periodic visual monitoring and reevaluation according to a site-specific schedule prescribed in the risk assessment report should be carried out to determine whether the dwelling unit continues to be free of hazards.

##### **B. When Interim Controls Are Appropriate and When They Are Not**

Unless precluded by regulation, interim controls are most easily implemented when most surfaces with lead-based paint are intact and structurally sound and lead exposure comes primarily from deteriorating paint and excessive levels of lead in household dust and/or soil. Interim controls are also appropriate if the housing unit is slated for demolition or renovation within a few years. In many cases resources will not be available to finance permanent abatement, making interim controls the only feasible approach.

If the housing unit has substantial structural defects or if interior or exterior walls or major components, such as windows and porches, are seriously deteriorated or subject to excessive moisture, interim controls are unlikely to be very effective. Paint cannot be effectively stabilized unless substrates are dry, structurally sound, and waterproof. Other interim control measures, such as window repair, would also not be very effective if structural problems are likely to result in rapid treatment failure. Any structural problems should be repaired before interim controls can be implemented. If these problems cannot be repaired, then more frequent reevaluation will be necessary in case of premature failure.

Federal, State, and local legislation or regulations may require that certain lead hazards be permanently abated rather than controlled on an interim basis. For example, HUD requires that public housing authorities abate all lead-based paint in dwelling units undergoing comprehensive modernization. Title X requires that lead hazards be abated in the course of substantial rehabilitation projects that use more than \$25,000 of Federal funds per dwelling unit. Some State and local governments have enacted laws and regulations requiring that certain lead hazards be abated.

Whenever building components are replaced, energy-efficient products should be used. This will help reduce energy consumption and also reduce the length of time it takes for new components (energy-efficient doors and windows) to pay for themselves.

### **C. Determining the Scope of Interim Controls**

The property owner may decide to rely on a risk assessor to determine whether interim controls are appropriate, identify treatment options, and estimate the long-term costs of the various available options. (See Chapter 5 for a discussion of risk assessments.) In some cases in which HUD funding will be used, a risk assessment or a paint inspection will be required. Some State or local laws may also strongly recommend or even require a risk assessment before lead hazard controls can be carried out.

Unless prohibited by local law, the property owner may elect to proceed with lead hazard control measures without a risk assessment or a paint inspection. When no evaluation is conducted, the property owner must assume that all surfaces have lead-based paint, all floors and dust traps are contaminated, and all bare soil is also contaminated. In this case, the property owner could waste money if surfaces are treated that do not contain lead-based paint. When there is a substantial likelihood that some treatable surfaces do not contain lead-based paint, the cost of risk assessment

may well be recovered by a more focused effort on confirmed hazards.

Some State and local laws prescribe certain treatments in order for the housing unit to qualify as lead-safe. Insurance companies or lenders may also prescribe certain treatments if a property is to qualify for insurance coverage or a loan. In all cases, the property owner should ensure, at a minimum, that required lead hazard control measures are carried out.

Whenever a housing unit is to be weatherized or rehabilitated, it is usually cost effective to control lead hazards at the same time. Usually, normal weatherization or rehabilitation activities can also eliminate some lead hazards if the work is modified so that it can be performed safely. However, if not carried out properly, these efforts will increase the risk of lead poisoning. In those situations, abatement is usually the most appropriate intervention since windows and other components are often replaced. It will usually be more expensive and disruptive to carry out weatherization or rehabilitation and lead hazard control separately.

### **D. Preparing a Lead Hazard Control Plan for Multifamily Housing**

Conducting interim controls of lead-based paint hazards in multifamily housing presents issues not generally found in single-family housing. In most occupied multifamily developments, it is not feasible, financially or logistically, to carry out hazard control activity in all dwelling units at once. In properties with a relatively small number of dwelling units, it may be possible to proceed unit by unit and complete the hazard control work quickly. In larger properties, however, decisions must be made as to the order of the work in dwelling units and common areas, and perhaps, in rooms or components within dwelling units and common areas. Even when an entire building is vacant and undergoing renovation, hazard control elements of the work must be identified and scheduled. Therefore, it is usually advisable that there be a lead hazard control plan for properties with more than approximately 10 units.

Owners should have an independent certified risk assessor prepare a lead hazard control plan to address lead-based paint hazards identified by the risk assessment or, if no risk assessment has been conducted, the specific hazards that are assumed to be present. The plan should prioritize and schedule control measures and any additional hazard evaluations so that available resources are targeted for maximum benefit. Lead hazard control planners or designers may also be helpful in preparing such a plan. In developing the plan, the risk assessor should consult with the property owner

to gain insights about the property to determine which strategies will be most appropriate. The goal of this consultation is to combine in the plan the risk assessor's knowledge of lead-based paint hazards with the property owner/manager's knowledge of the particular property—its maintenance history, persistent problems, occupancy profile, capital improvement program, etc.

In developing a lead hazard control plan, it is reasonable to consider treating units occupied by children under age 6 or pregnant women first. Common play areas, day-care centers, or dwelling units serving as day-care centers may also be candidates for early treatment. It is reasonable to consider the fact that it is less expensive to conduct hazard controls effectively and safely in vacant units than in occupied units; thus, it may be appropriate to postpone some hazard control treatments until unit turnover. It is reasonable to consider the possibility of relocating families with young children from uncontrolled units to hazard-controlled vacant units in order to more quickly and cost effectively reduce childhood exposure to lead in the environment.

At a minimum, a lead hazard control plan should include the following elements:

- \* A schedule for hazard control, usually in units with young children or pregnant women first, followed by other units. The schedule should show how lead-based paint hazards will eventually be controlled in *all* units.
- \* A commitment on the part of the owner and manager to control lead-based paint hazards that are generated during routine maintenance work or normal building aging, what those controls consist of, and how those controls will be implemented.
- \* Specific measures that will be taken during unit turnover (often paint stabilization, specialized dust removal, and perhaps the provision of cleanable surfaces on floors, sills, and troughs and some minor building component replacement).
- \* A schedule for performing risk assessments, lead hazard control screens, and inspections and/or clearance examinations in all units or a representative sample of units.
- \* A schedule for hazard control actions to be completed in common areas.
- \* A schedule for reevaluations and visual monitoring by certified risk assessors and owners or their representatives, respectively.

\* A description of how maintenance workers and other staff will be trained to handle lead-based paint hazards safely.

\* Designation of an individual, preferably on the staff of the owner or the property manager, who is responsible for matters associated with lead-based paint hazards.

### **E. Combinations of Interim Controls and Abatement of Certain Hazards**

In many dwellings owners will choose a combination of interim controls *and* abatement. This decision is best made by consulting a certified risk assessor. For example, it is possible to stabilize deteriorated lead-based paint and remove excess levels of leaded dust (interim controls), but at the same time enclose some lead-based painted surfaces, replace some lead-based painted components, or remove lead-based paint from some surfaces (abatement). Such combinations of interim control and abatement treatments might well be the most cost-effective response to a property owner's lead hazard problem, particularly if carried out when the dwelling unit is vacant.

### **F. Qualifications of Interim Control Contractors**

Title X does not require certification of contractors who carry out interim controls. However, OSHA requires that all interim control workers be trained under 29 CFR 1926.21(b)(2), even if lead exposures are below the action level (see Chapter 9). Interim control activities frequently disturb lead-based paint and typically take place in areas with excessive levels of leaded dust. Therefore, while not required by EPA, it is recommended that interim control workers and supervisors, whether employed by the property owner or an independent contractor, be trained, preferably through an accredited abatement course.

### **G. Cleanup and Clearance**

Section IV of this chapter describes how leaded dust can be removed as an interim control measure. In some dwellings dust removal from a few surfaces may be sufficient. Chapter 14 describes cleanup after abatement or a more comprehensive set of interim control measures. Whether leaded dust is removed as the primary element of interim control or as final cleanup after more comprehensive control activity, the objective is the same—providing residents with a clean and easily cleanable unit.

Like abatement, interim controls are intended to make a dwelling unit safe for children; therefore, interim controls are subject to the same clearance testing requirements and documentation as abatement. Clearance examinations *must* always be conducted follow-

ing interim control work (Chapter 15 describes clearance examinations).

### **H. Education**

While education of the residents, particularly the children's caregivers, is not in itself sufficient to prevent childhood lead poisoning, it can assist residents in reducing the risk that their children will be seriously poisoned.

Therefore, education is an important adjunct to any lead hazard control system.

The property owner is responsible for the condition of the dwelling unit and for advising occupants to report any deteriorating paint. The owner should also distribute to the occupants any educational materials furnished by the State or local government or by a local lead poisoning prevention organization.

The educational materials should advise occupants of all the potential sources of lead poisoning. This includes lead-based paint, lead-contaminated dust and soil, and also lead in water, pottery glazes, glass, some imported cosmetics, and home remedies. Materials should suggest simple preventive measures, such as washing children's hands before eating and after play, and washing toys. Children's nutrition is also important. Foods high in iron and calcium reduce absorption of lead into children's bodies while fatty foods increase the rate of absorption. The EPA Lead Hazard Information Pamphlet is a useful resource that can be obtained by calling 1-800-LEAD-FYI. Property owners, managing partners, and remodelers should also obtain these educational materials.

### **I. Maintenance, Monitoring, and Reevaluation**

See Chapter 6 for a complete discussion of reevaluation and Chapter 17 for information on maintenance. The success of interim control measures depends not only on the adequacy of their initial application, but also on whether they remain effective over time. To remain effective they must be maintained and monitored. Property owners or their agents should routinely (e.g., annually) visit the property and visually ensure that interim controls remain in place. They should also respond promptly whenever an occupant reports any deteriorating paint. Any failure of interim controls that is identified should be corrected promptly.

An important component of maintenance is ensuring that leaded dust levels remain below acceptable levels. This can best be achieved through regular cleaning of areas where leaded dust is likely to accumulate.

Property owners should, therefore, undertake thorough cleaning of the unit upon vacancy if, during ongoing monitoring, they find that excessive levels of leaded dust have accumulated.

To ensure a reasonably lead-safe environment for young children, dwelling units that continue to contain lead-based paint and potential lead hazards should be reevaluated by a certified inspector or risk assessor. The schedule should be developed on a site-specific basis.

### **J. Resident Protection During Control Activities**

Any activity that disturbs lead-based paint can generate leaded dust. While interim control activities are less likely to generate leaded dust than abatement activities, any scraping or sanding without high-efficiency particulate air (HEPA) attachments can generate dangerous levels of dust. Whenever dust-generating activities are carried out, residents and particularly young children should stay out of the rooms (preferably the entire house) and should not return until all dust and debris are removed and the dwelling unit has been thoroughly cleaned (see Chapter 8).

### **K. Waste**

Most interim control activities are not expected to generate hazardous waste since interim controls will generate less than 100 kilograms of lead per month, exempting them from hazardous waste regulations. See Chapter 10 (Hazardous and Nonhazardous Waste) for further guidance.

### **L. Statements of Lead-Based Paint Compliance**

State or local governments may require inspectors or risk assessors who carry out clearance examinations to provide a Statement of Lead-Based Paint Compliance. The Statement would provide evidence that described interim controls have been completed and that leaded dust levels are at or below applicable standards. Insurance companies and lenders could rely on the Statement in framing their underwriting criteria. Such a system would provide an inducement for property owners to control lead hazards and give them hard proof of compliance.

The Statement of Lead-Based Paint Compliance would be valid for a limited period of time based on the standard reevaluation schedule for the property. The Statement could be extended when a reevaluation demonstrates that the conditions of lead safety continue to be met. Some States may limit the number of recertifications. Others may permit recertification until some event such as substantial rehabilitation takes place. Insurance companies or lenders may impose their own requirements.

## **M. Documentation**

Lead hazard evaluation, lead hazard control, and maintenance and monitoring activities associated with interim controls should be documented. Several specific documents are of particular importance. These include:

1. Risk Assessment and/or Inspection Report. This document records the findings of any risk assessment or inspection, including any inspection of painted surfaces and the collection and analysis of samples for determination of the lead content in dust, soil, and/or water. A risk assessment that finds no lead-based paint hazards would also justify issuance of a certificate.
2. Lead Hazard Control Plan. This document explains the schedule of hazard control actions in multifamily housing (see section I.D. of this chapter).
3. Clearance Examination Report. This document records the basis for clearance of the property so that it is ready for occupancy (see Chapter 15).
4. Reevaluation Reports. These reports indicate that the hazard control measures are still in satisfactory condition and that the dwelling is still in a lead-safe condition. Reevaluations are performed on a schedule discussed in Chapter 6.
5. Maintenance and Monitoring Log. This log records the results of the property owner's or property manager's monitoring visits. Any repairs made as a result of these visits or notices of defects from occupants should also be recorded.
6. Statement of Lead-Based Paint Compliance. This document states that on a particular date the inspector or risk assessor confirmed through an onsite investigation that the dwelling met applicable requirements. The Statement of Lead-Based Paint Compliance is issued to the property owner, with copies provided to the residents and to the State or local code enforcement authority, if required under State or local law or regulation. The Statement of Lead-Based Paint Compliance is valid for a limited period of time based on the site-specific reevaluation schedule contained in the risk assessment report.

## **Step-by-Step Summary**

### **Paint Film Stabilization: How To Do It**

1. Eliminate any exterior leaks in the building envelope (e.g., roofing leaks, gutter or downspout problems, missing or damaged doors, roof flashing, missing opening trim, missing glass in windows, defective or missing caulk and glazing, loose fasteners).
2. Eliminate any interior water leaks (e.g., plumbing leaks; clogged condensate drip lines for air conditioners; missing water pans for hot water heaters; inadequately ventilated attic spaces; clogged bathtub drains; missing tile, grout, or caulking in bathtubs; windows that won't close completely).
3. Select and implement an appropriate Worksite Preparation Level (see Chapter 8).
4. For exterior work, collect soil samples before the work begins (unless soil sampling has already been completed for a risk assessment). These samples need not be analyzed unless clearance samples show soil lead levels are above applicable clearance standards.
5. Repair all rotted structural, siding, or railing components; defective plaster; missing door hardware; loose siding or trim; and loose wallpaper.
6. Prepare surface by wet scraping or wet sanding. Do not remove paint by burning or torching, power sanding without HEPA attachments, or abrasive blasting. Dry scraping and chemical strippers with methylene chloride are not recommended.
7. Clean, degloss, neutralize, and rinse surfaces. Surfaces should be dry before priming or repainting.
8. Select primer and topcoat by considering longevity, moisture resistance, and organic compound content with low volatility. Paint film stabilization involves the application of at least two coats (the primer and the topcoat). Use a primer/topcoat system from the same manufacturer to ensure compatibility.
9. Apply all paints at appropriate thickness (see Table 11.1) or according to manufacturer's directions. Apply paint only during proper temperature, wind, and humidity conditions. Allow sufficient time for each coat to dry fully.
10. Conduct final cleanup (see Chapter 14).
11. At the end of the lead hazard control project, have a certified inspector technician or risk assessor conduct a clearance examination and provide appropriate documentation or statements of lead-based paint compliance.
12. Conduct reevaluations annually as indicated in the site-specific schedule (Table 6.1). Perform ongoing maintenance of paint and restabilize paint whenever deterioration is discovered.



## Section II

### II. Paint Film Stabilization

#### A. Typical Lead Coatings and Their Failures

The lead in lead-based paint may be found as white pigments (lead carbonate, sulfate, or silicate), or colored pigments (chrome yellow, red lead, gray, and other orange, green, and red pigments). These pigments were mixed with other components in an oil vehicle, and traditionally thinned with volatile organic solvents and a drying agent. Driers containing lead were used to accelerate the conversion of the liquid coating to a dry film. Paint films can fail rather quickly under real-life conditions, making ongoing monitoring important. Paint films should be quickly but carefully stabilized whenever a resident or owner reports that paint is deteriorating.

##### 1. Moisture

Oil paints (virtually all lead-based paints are oil paints) form a hard, usually glossy, low permeable and inflexible coating. Water, either in the form of water vapor or liquid, is the single greatest cause of premature paint coating failures. Once a substrate gets wet, the impermeable paint coating is pushed away from the substrate due to vapor formed by heat from the sun or other sources. Repeated soaking/ warming cycles result in microscopic failure of the paint and then an accelerated failure as more and more openings become available, allowing the substrate to become increasingly wet. Expansion and contraction caused by small ice crystals during the wet winter months also cause paint deterioration.

A significant number of homes are poorly constructed, ventilated, or maintained, and allow moisture to be trapped. The 26 main causes of premature paint failure from moisture are described in Figure 11.1.

##### 2. Aging

All binders age and some cure over time. This continued curing causes the paint to become too brittle to accommodate the normal expansion and contraction of the substrate, resulting in cracking and peeling.

Exterior paints are also attacked by sunlight, which can cause chalking. These slow aging processes mean that even a well-managed and protected surface will deteriorate eventually.

##### 3. Mechanical Damage

The two basic kinds of mechanical damage (abrasion and impact) can be minimized only by careful management. Paints exhibit tremendous variability in hardness, impact resistance, and abrasion resistance. High-performance coatings (e.g., polyamide epoxy, urethane-reinforced alkyds, and epoxy-modified enamels) can withstand over 10,000 more scrubbing cycles than inexpensive flat vinyl paints (Banov, 1978), although some of these paints may not be appropriate for residential use. Failure from impact or friction is often accelerated by the selection of a low-performance coating.

##### 4. Chemical Incompatibility

Since oil and water do not mix, oil paints applied over wet substrates will not adhere. The failure may occur within a week, and may cause the paint film to be pulled directly from the substrate. Although oil paints stick relatively well on surfaces slightly contaminated with organic material, dirt, and oil, they do not adhere well to fatty or heavily greased surfaces.

Most latex paints do not adhere to chalky or smooth and glossy paint films. Epoxies will fail prematurely when applied over latex coatings and some oil coatings. Some chemical-based strippers contain such large amounts of wax and other stabilizers that almost no subsequent coating will maintain good adhesion. If the substrate has been stripped with a caustic paste and not neutralized properly, the highly alkaline pH will cause deterioration of the subsequent paint. On the exterior, salts may build up on the surface of paint films in eaves and soffits and prevent paint adhesion. These salts must be removed with water to allow good adhesion.

Portland cement and older plaster substrates are extremely alkaline and should be aged or etched with mild acid solutions prior to spot sealing with a primer.

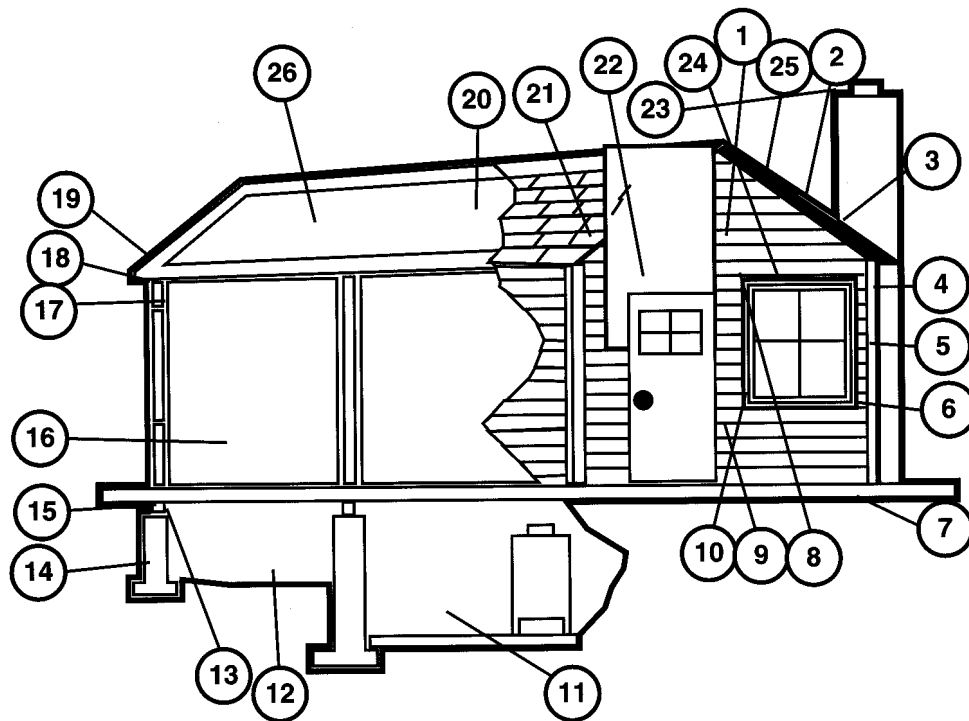
**Figure 11.1 Moisture-Related Causes of Paint Failure.**

(1) siding exceeds 14-percent water content; (2) no cricket where chimney meets roof; (3) no step flashing at side of chimney; (4) corner rim not caulked; (5) exposed nailheads rusting; (6) no window wash at window sill; (7) wood contacts earth; (8) no drip or gutter at eaves; (9) poorly fitted window and door trims; (10) waterproof paper not installed behind trim; (11) damp, wet cellar unventilated at opposite sides; (12) no ventilation of unexcavated space; (13) no blocking between unexcavated space and stud wall space; (14) no waterproofing or drainage tile around cellar walls; (15) no foundation water and termite sill; (16) plaster not dry enough to paint; (17) sheathing paper that is not waterproof; (18) vapor barrier omitted—needed for present or future insulation; (19) roof built during wet, rainy season without taking due precaution or ventilating on dry days; (20) roof leaks; (21) inadequate flashing at breaks, corners, roof; (22) poorly matched joints; (23) no chimney cap; (24) no flashing over openings; (25) full of openings, loosely built; (26) no or inadequate ventilation of attic space.

## 5. Poor Surface Preparation

A 100-year-old house, repainted every 8 years, may have at least 12 coats of paint. If surface preparation for only one of those coats was insufficient, localized failures will occur. Because of the slow erosion of the binder in exterior paints, chalking can cause poor adhesion of new coatings. Chalk must be removed and appropriate primers applied to prevent subsequent failures. Surfaces must be free from oil, grease, and dirt. Paint stripper residue must be removed, either with solvents or alkali cleaners such as trisodium phosphate. Hard, glossy oil films require deglossing to allow waterborne coatings to adhere properly.

## B. Substrate Condition and Repairs

### 1. Building Envelope Leaks

The quality and endurance of a paint coating is dependent on the quality of the substrate over which it is applied. The substrate must be dry, structurally sound, and waterproof. Roofing leaks, including porches, gutters, and downspouts, must be fully repaired prior to stabilizing the lead-based paint film. Temporary roofing repairs like asphalt patching material, piecing in downspouts and gutters, and short-term paint on coatings are not recommended. Within 4 months,

these quick fixes may fail and result in subsequent failure of the lead-based paint.

The purpose of painting is to protect the substrate and improve its appearance. In lead-based paint stabilization, the main goal is to make intact a dangerous, poisonous coating to prevent excessive lead exposures. Paint stabilization is most effectively and economically completed after the following defects have been fully corrected:

- \* Damaged or missing roof flashing.
- \* Damaged or missing door and window flashings.
- \* Siding in contact with soil.
- \* Water running down siding.
- \* Missing or deteriorated opening trim.
- \* Missing glass in windows.
- \* Missing, damaged, or deteriorated caulking.
- \* Loose and rusty fasteners.

## 2. Interior Repairs and Water

The major type of repair that must be completed prior to paint film stabilization involves eliminating moisture sources. Plumbing leaks, especially in bathrooms and kitchens, are often the cause of paint film failure on the ceilings and walls below. A few major soak/dry cycles can bring the lead-based paint or leach lead salts to the surface. The following interior defects should be corrected permanently in conjunction with interior lead-based paint stabilization projects:

- \* Visual leaks in waste lines, traps, supply lines, or fixtures above or in rooms undergoing stabilization or where suspected lead-based paint is present.
- \* Clogged condensate drip lines for air conditioners.
- \* Water heaters and washers without pans and overflows above or in rooms undergoing stabilization or where suspected lead-based paint is present.
- \* Inadequately ventilated attic spaces.
- \* Inadequately ventilated bathrooms, kitchens, and laundry areas.
- \* Clogged bathtub drains.
- \* Interior windows that are loose or do not close completely.
- \* Broken or missing glass in windows.
- \* Improper or deteriorated caulking in bathrooms or kitchens.
- \* Plugged or blocked weep holes in storm windows.

Needless friction and abrasion points on lead contaminated surfaces should also be repaired. As structures age, sag, and adjust, components can bind or abrade each other. The following friction points should be eliminated when discovered on lead-contaminated surfaces (see Section III):

- \* Doors and doorjamb, heads, and thresholds.
- \* Cabinet doors and drawers.
- \* Window sashes, jambs, heads, and parting beads.

## 3. Water Vapor Management

Paint exposed to excess water vapor can fail within hours of initial application. Almost all exterior trim flashing and caulking serves a functional purpose by covering seams and joints and keeping out air and water. All missing or deteriorated trim, flashing, and caulking should be replaced prior to stabilization. Open cracks in bathrooms and kitchens should be taped with fiberglass mesh wall tape, spackled, and then sealed to eliminate water penetration. Minor repairs to the plaster substrate should be completed, allowed to dry, and sealed with white shellac or an acrylic latex. Exterior cladding and attic spaces should be ventilated to allow the escape of water vapor. Small wedges can be driven between clapboards, circle vents can be installed, or the walls may be sealed from the inside using caulking and a very low-permeable primer. Soffit and ridge ventilation of at least 1 square inch of vent per 300 square inches of ceiling area is recommended. The following vapor maintenance defects should be permanently corrected prior to stabilizing lead-based paint:

- \* Deteriorated or missing caulking or grout at tub and shower surrounds.
- \* Painted-over vents on siding or roof.
- \* Deteriorated or missing caulking that allows air infiltration (e.g., at trim, outlets, light fixtures, pipe penetrations).
- \* Crawl space not covered with low-permeable barrier (vapor barrier).

## 4. Substrate Repairs

Prior to stabilizing lead-based paint, the following defects must be permanently corrected:

- \* Dry rotted or rusty structural, siding, or railing components.
- \* Wall and ceiling plaster that is loose from the underlying lath (sagging plaster).
- \* Missing door hardware (e.g., hinges or knobs).

\* Loose siding or trim.

\* Loose wallpaper.

## C. General Paint Application Guidelines

### 1. Appropriate Conditions

Because the guidelines in this chapter have been developed primarily to stabilize and seal lead-based paint, the general requirements for repainting should be rigorously followed. The painters should be professional, skilled, and willing to guarantee their work. Strict adherence to the paint manufacturers' recommendations for air and substrate temperatures, required primers, relative humidity, and recoating time should be conscientiously enforced. The completed primer and topcoat must be applied at the manufacturers' coverage rate and should never be thinner than 2.5 mil. Table 11.1 contains other recommended procedures for paint film stabilization.

### 2. When Paint Film Stabilization Will Not Last Very Long

Under certain conditions, paint stabilization will not last very long. These are:

- \* Prerequisite repairs not possible.
- \* High probability of future physical damage.
- \* Stairwell walls with visual and likely physical damage (enclosure with wood wainscot is an acceptable alternative to paint stabilization).
- \* Children's play equipment (removal of paint or disposal of equipment are better options).
- \* Wall surfaces that are structurally unsound.
- \* Walls with a layer of wallpaper over or under lead-based paint.
- \* Weep holes in storm windows not cleared to allow ventilation and drainage of water.

**Table 11.1**  
**Recommended Minimum Thickness of Dried Paint Film**  
**for Lead-Based Paint Stabilization (in mil)**

Topcoat	Primer Thickness	Topcoat Thickness	Total Coating Thickness
Acrylic enamels	1.0	1.5	2.5
Alkyd enamel	1.0	1.5	2.5
Water-reducible epoxy	1.0	2.0	3.0
Urethane-modified alkyd/porch and deck enamel	1.0	2.0	3.0
Epoxy-modifier enamel	1.0	2.0	3.0

Paint film stabilization will yield the best results when the surface and building system have been properly prepared. If prerequisite repairs cannot be completed before paint film stabilization, the reevaluation period should be shortened substantially. The owner's monitoring frequency should also be increased.

### D. Worksite Preparation

Choice of Worksite Preparation Level depends upon the size of the area to be stabilized and other factors (see Chapter 8). Occupants should never be present in the work area. Plastic sheeting should be used to capture falling paint chips and make the cleanup process more efficient.

For exterior work, soil samples should be collected before the work begins. These samples need not be analyzed until post-abatement soil samples have been collected, analyzed, and compared to clearance standards. If soil samples collected after the work has been

completed are below applicable limits, the preinterim control samples need not be analyzed (see Chapter 15).

### E. Paint Removal Methods

The recommended approaches to surface preparation are as follows:

- \* All loose surface material should be removed by hand treatments (i.e., wet scraping, wet sanding).
- \* Surface contaminants that prevent adhesion should be eliminated by cleaning (e.g., chemical degreasing, trisodium phosphate washing, or other equivalent detergent followed by thorough rinsing).
- \* Surface gloss should be eliminated by chemical etching or HEPA vacuum-assisted sanding.
- \* Adhesion to the substrate should be enhanced by chemical etching, applying rust inhibitors, spot sealing, and/or wet sanding.

Certain paint removal practices are prohibited, including open-flame burning or torching, machine sanding or grinding without using a HEPA vacuum local exhaust system, uncontained hydroblasting or high-pressure wash, open abrasive blasting or sandblasting without using a HEPA vacuum, and use of heat guns above 1,100 °F.

Other paint removal practices are not recommended, including dry scraping (except for limited areas) and use of chemical strippers containing methylene chloride.

Further information on these prohibited methods is provided in Chapter 12, Section IV.

### 1. Wet Scraping

The goal of safe scraping is to minimize the creation of dust while removing loose paint. The best tool for this work is a scraper attached to a HEPA vacuum, which very efficiently removes small dust particles generated during scraping.

The large chips that fall to the floor will be captured by the 6-mil plastic floor containment. Continuously misting the surface with water from a small atomizer or garden-type sprayer will minimize dust generation. A small amount of detergent can be used as a wetting agent. This procedure is best completed by two people—one scraping, the other wetting the surface. Simple dust-gathering devices, like a damp rag wrapped around the head of a draw scraper, capture the smallest dust particles while directing the larger paint chips onto the floor containment area (see Figure 11.2).

### 2. Wet Sanding

When preparing a surface by sanding (especially with fine-finishing grits), it is quite possible to contaminate an entire household with fine particles of lead-contaminated dust. Traditional orbital sanding devices may be used *only* in conjunction with a HEPA vacuum filter attachment (see Figure 11.3). Dry sanding should be replaced by wet sanding except near electrical circuits.

Any liquid that does not interfere with subsequent paint adherence may be used (e.g., water, Varsol, phosphoric acid etch for iron, and trisodium phosphate).

Patching material for drywall, plaster, and wood can be wet sanded using sponges (see Figure 11.4).

Wood, metal, and painted surfaces that require a fine cosmetic finish may be sanded using wet-dry sandpaper and water or an oil paint solvent. Relatively rough surfaces may be finished using wet foam sanding

blocks created by dipping a sponge in an aluminum oxide grit. These sponge sanders are ideally suited for wet sanding and can be easily cleaned by immersing in a bucket of trisodium phosphate or other cleaner.

Rather than sanding to get a grip on an old gloss coat of paint, the painter should chemically treat the surface with specialized products such as Liquid Sandpaper™, taking care to provide adequate ventilation if volatile substances are released.

## F. Surface Cleaning

### 1. Dust and Chips

Good surface preparation will remove damaged, oxidizing, and deteriorated paint surfaces, but will also create leaded dust and chips. Therefore, after the surface has been allowed to dry, it should be HEPA vacuumed to collect surface dust. Prior to applying primer, the surface should be tested for its pH by placing litmus paper against the wet surface (see Figure 11.5). The surface must be rinsed with clear water or a weak acid solution until it reaches a pH between 6 and 8 for most new paints.

### 2. Oils, Waxes, and Mold

While oil and alkyd paints have some tolerance for oil in the substrate, acrylic latex paints will fail prematurely if applied over greasy or oily surfaces. For waxes like crayons and some polishes, a combination of household ammonia and water should be used for cleaning, followed by a thorough rinse. Surfaces in baths and kitchens that may be prone to contamination by airborne grease and oils, fatty soap films, or mold can be cleaned with a 5- to 6-percent solution of trisodium phosphate or other suitable cleaner and rinsed thoroughly. On some varnished kitchen cabinets, the finished surface may become coated with organic films after extended use. The surface should be cleaned with a nonflammable solvent before painting.

## G. Priming

To maximize the life of a paint job, a system of compatible coatings is necessary. Primers are designed to adhere tightly to the old paint while leaving a rough, bondable surface on the outside. Prior to priming wood and plaster, substrates should have a moisture content of no more than 15-percent relative humidity on the exterior and 10-percent relative humidity on the interior. Top-quality primers work better, last longer, and treat more substrate types. Consider the following factors when selecting a primer:

\* Type of substrate (e.g., wood, metal, gypsum, masonry).

\* Type of existing substrate coating (e.g., acrylic latex paint, varnish, oil enamel).

\* Interior or exterior application.

\* Topcoat (only use manufacturers' recommended primers; use a single manufacturer for both primer and topcoat).

**1. Oil- and Alkyd-Based Primers**

Oil primers are compatible with a system of multiple coats of oil paint over a wood or plaster substrate. The similar solvents used in the old and new paints have a tendency to soften the surface of paint, creating a better bond. Oil primers are also effective vapor barriers. On the other hand, oil primers contain volatile organic chemicals that can cause adverse health effects and may cost more than waterborne paints. Many States regulate the amount of volatile organic chemicals in paint.

**2. Waterborne Primers**

The most durable waterborne paints are made with an acrylic or acrylic-containing binder. While acrylic latex primers and topcoats are an excellent combination for new wood, they may not be compatible with the lead-based oil paints that cover the substrate. Waterborne paints usually emit less volatile organic compounds and may be less expensive than oil paints.

**H. Topcoats**

To maximize cost-effectiveness and prolong the efficiency of a coating used as a lead hazard control method, it is important to purchase paint with a long lifespan. Inexpensive, low-grade paint or special mixes should not be used in lead-based paint stabilization programs. Paints and clear finishes used for paint stabilization jobs require outstanding adhesion, durability, chemical resistance, and flexibility. Therefore, the owner should request the most durable and the highest grade of paint.

Marine paints free of lead and mercury and varnishes (used on boats, docks, etc.) are especially durable and abrasive-resistant, because they are formulated with more resin than house paints and the resin is of the highest quality. However, some marine paints are not appropriate for residential use (e.g., bottom paints or mildew-resistant paints contain poisons and must be avoided, so that lead is not replaced by another toxic substance). High-gloss floor and deck enamels offer the next best level of protection. In general, the higher the gloss, the more durable, impact-resistant, and

moisture-resistant the coating. Among types of paint finishes, gloss, semigloss, and eggshell coatings are much more resistant to abrasive cleaners and the detergents used in followup maintenance procedures than flat finishes.

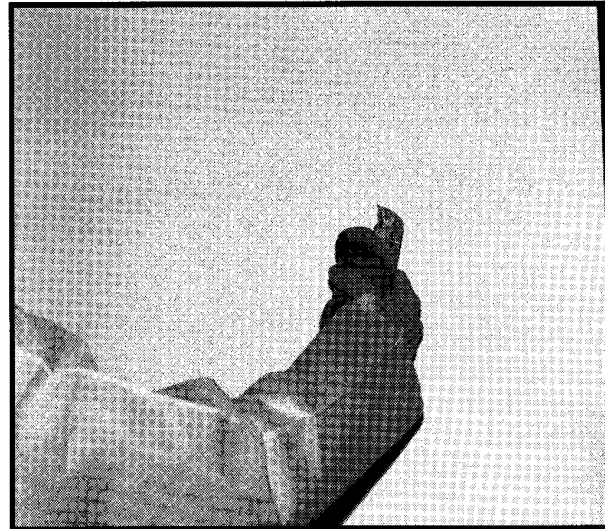
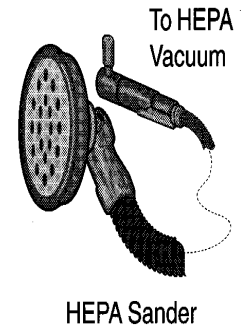

**Figure 11.2 Wet Scraping Tool.**

**Figure 11.3 HEPA Vacuum Sanders.**

**HEPA Sanders**

Sanding generates huge amounts of dust. HEPA sanders are sanders fitted with a HEPA vacuum to catch and filter lead dust as it is created. Use a HEPA sander when sanding lead paint. Limit the use of HEPA sanding to flat surfaces for feathering or finishing only.



**HEPA Sander**

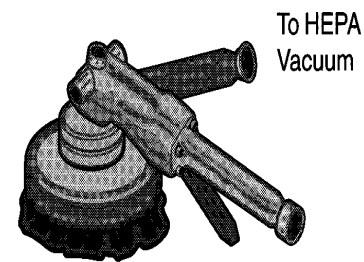

**To HEPA Vacuum**

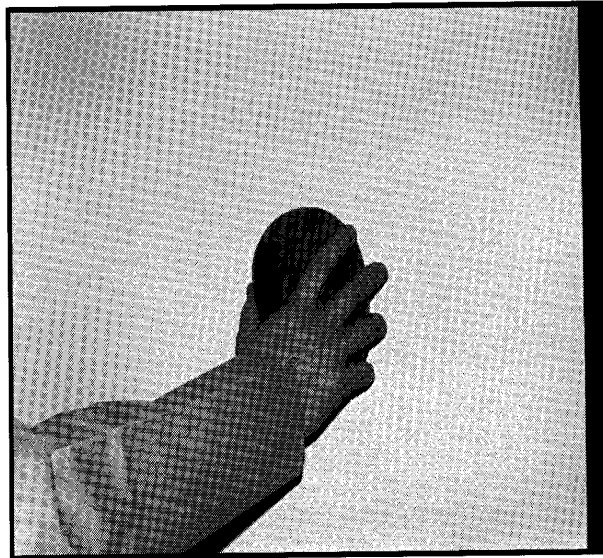

**Figure 11.4 Use a Sponge To Wet Sand and Smooth New Patching Material.**

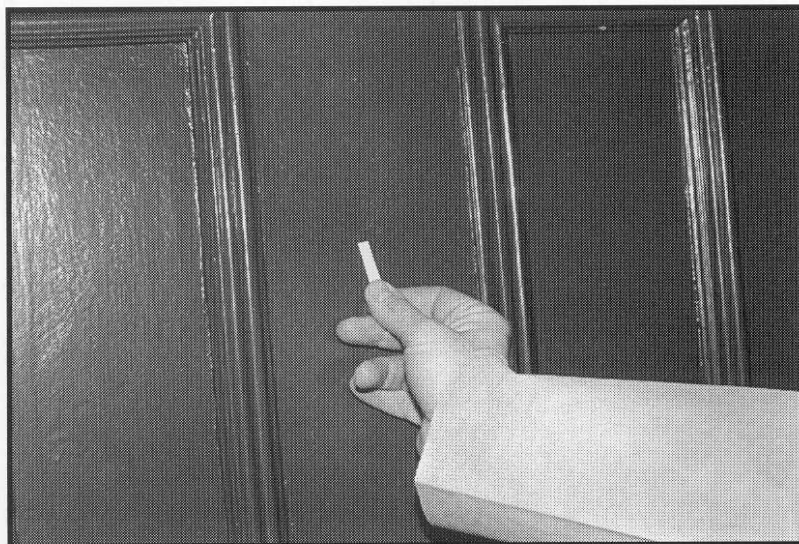

**Figure 11.5 Use Litmus Paper To Determine the Surface pH Before Applying New Paint.**

A satisfactory service life of 4 to 10 years may be achieved with latex and alkyd-based paints, although much more rapid deterioration can occur under adverse conditions. High-performance coatings applied properly to ideal substrates may offer a service life of 10 to 25 years. High-performance coatings include epoxy-modified alkyds, epoxies, urethanes, epoxy-polyesters, and polyesters. However, these types of coatings should only be selected after consulting the manufacturer as to the specific intended use(s) and after considering the following factors:

\* Possible presence in the new coating of lead, chromate, mercury, and other heavy metals (and other toxic substances).

\* Compatibility with existing paint film.

\* Ability to be repainted in future maintenance operations (epoxies and urethanes are difficult to repaint).

Some lead-based paint encapsulants are made out of similar materials and may last longer than paints on some surfaces (see Chapter 13).

A 100-percent acrylic latex product could last 10 years on the average exterior under optimal conditions (Cassens and Feist, 1991). A low-cost nonacrylic latex may last less than 4 years. The additional material costs (126 percent to 200 percent) of high-priced paints and any special primers are minimal when compared to the cost of performing more frequent paint film stabilization. (See Table 11.3 for finishes typically used for lead-based paint stabilization.)

### **I. Cleaning and Clearance**

Containment removal, extensive cleaning, and clearance testing is required following stabilization and recoating. (See Chapters 14 and 15 for discussion of cleaning and clearance.)

### **J. Reevaluation and Monitoring of Lead-Based Paint Stabilization**

Immediately after completion of any paint stabilization job, the paint begins the slow process of deterioration from mechanical damage, ultraviolet rays, rain, snow, and wind. A well-prepared substrate, which is

sealed, primed, and topcoated with premium house paints, can withstand between 4 and 10 years of weathering in temperate climates. At the other extreme, a small scratch in a metal railing located in a coastal town may lead to extensive corrosion and major paint failure within a much shorter time. Assuming a proper paint job, paint life is directly related to the environment to which it is exposed. Cyclical changes in the environment are responsible for the greatest rate of paint destabilization. Rapid changes in temperature, moisture content, and relative humidity cause small stress cracks at joints and between dissimilar materials. Exterior paint life can be extended considerably by annual inspections and maintenance (spot scraping, spot priming, and topcoating deteriorated areas). While a new paint job on interior plaster and wood can last 5 to 10 years with only minor fading, repainting will be required much more frequently in dwellings with more wear and tear. Spot priming and spot topcoating as soon as a deterioration is noticed can extend the life of the interior surfaces.

**Table 11.2**  
**General Recommendations for Applying Paint**

- 
- \* Paint only when surface and ambient temperatures are between 50°F and 90°F when using a water-thinned coating, and between 45°F and 95°F for other types of coatings.
  - \* Maintain coatings in container at a temperature range of 65°F to 85°F at all times on the job.
  - \* Paint only when the temperature is expected to stay above freezing.
  - \* Paint only when wind velocity is below 15 mph.
  - \* Paint only when relative humidity is below 80 percent.
  - \* Observe the recommended spread rate for each kind of coating.
  - \* Tint each coat differently if the same paint is to be used for successive coats to ensure complete coverage.
  - \* Allow sufficient time for each coat to dry before applying another. Use the same brand for each coat.
  - \* Allow adequate time for the topcoat to dry before permitting service to be resumed.
  - \* Do not put doors back into use until they have dried completely.
  - \* Do not paint over weep holes in the bottom of storm window systems; if the weep holes are blocked or plugged, drill a hole to permit proper ventilation and drainage of rainwater. Failure to clear weep holes will cause premature paint failure in window troughs.
-



**Table 11.3**  
**Finish Coats for Lead Based Paint Stabilization**

<b>Options</b>	<b>Base</b>	<b>Cost per Gallon</b>	<b>Difficulty Level</b>	<b>Comments and Recommendations</b>
Varnish	Oil alkyd resin, clear finish	\$18–\$36		Can be touched up very easily.
Acrylic latex	Water	\$12–\$18	Safest and easiest to use.	May not adhere to alkyd enamels.
Polyurethane resins:				
Alkyd	Oil–volatile organic solvent	\$20–\$36	Easy to apply. Very durable.	Cannot be touched up without sanding off gloss.
Moisture–cured	Volatile organic solvent	\$32–\$38	Harder to apply.	Needs adequate relative humidity to cure.
Waterborne clear finish	Polyurethane water	\$35–\$60	Can be hard to apply.	Safer to apply than organic solvent–containing coatings.

Source: Adapted from A Consumer's Guide to Renovation, Repair and Home Improvement, J. Wiley & Sons, 1991.

## **Step-by-Step Summary**

### **Friction and Impact Surface Treatment: How To Do It**

1. Select and implement the appropriate Worksite Preparation Level (see Chapter 8).
2. For windows, remove stop bead and parting strip and dispose of properly. Wet scrape deteriorated paint. If the window trough is badly weathered, cap with back-caulked, aluminum coil stock. If necessary repair window weight and pulley system. Install new window channel or slide system and replace stop bead (and parting strip if required).
3. For doors, remove doorstop and dispose of properly. Remove door by pulling out hinge pins. Mist and plane door to eliminate friction points. Reinstall door and install new doorstop.
4. For stairs, install a hard, cleanable covering on treads (i.e., rubber tread guards). Carpeting may be used instead, but it must be securely fastened so that it does not cause abrasion. Stabilize paint on banisters, balusters, and newel posts.
5. For baseboards, remove and dispose of shoe molding and replace.
6. For abraded outside wall corners, install new plastic or wood corner bead.
7. For drawers and cabinets, remove and replace cabinet doors or remove paint by offsite stripping. Strip paint from drawers and drawer guides or plane impact points and repaint. As an alternative, install rubber or felt bumpers at points of friction or impact.
8. Repaint porches, decks, and interior floors.
9. Have a certified risk assessor or certified inspector conduct a clearance examination.
10. Perform ongoing maintenance and monitoring of treatments. Reevaluations should be conducted by certified risk assessors based on the reevaluation schedule for the specific property (see Chapter 6).
11. Provide educational materials to residents. Information should include proper cleaning routines and the sticky tape method of removing loose paint.

### Section III

## III. Friction and Impact Surface Treatment

### A. Definition of Terms

#### 1. Friction Surfaces

Friction surfaces are those surfaces covered with lead-based paint that are subject to abrasion, which may generate leaded dust. The most critical friction surfaces are generally those portions of a window that are rubbed when the window is opened and closed (see Figure 11.6). The actual area(s) of adjacent surfaces that rub together should not be painted. This includes the jamb, stop bead, and parting strip, and sometimes the sash. Other common friction surfaces include

tight-fitting or rubbing doors, cabinet doors and drawers, stairway treads and railings, and floors painted with lead-based paint, including exterior decks and porches.

Friction surfaces on doors and windows will generate less leaded dust when they are kept in good operating condition and in a state of good repair. Friction surfaces can also often be covered with a temporary or permanent covering to eliminate the friction. The covering itself, however, must be abrasion-resistant.

However, if the component is deteriorated, it may be more cost effective to simply replace it than to attempt to treat friction surfaces (see Chapter 12).

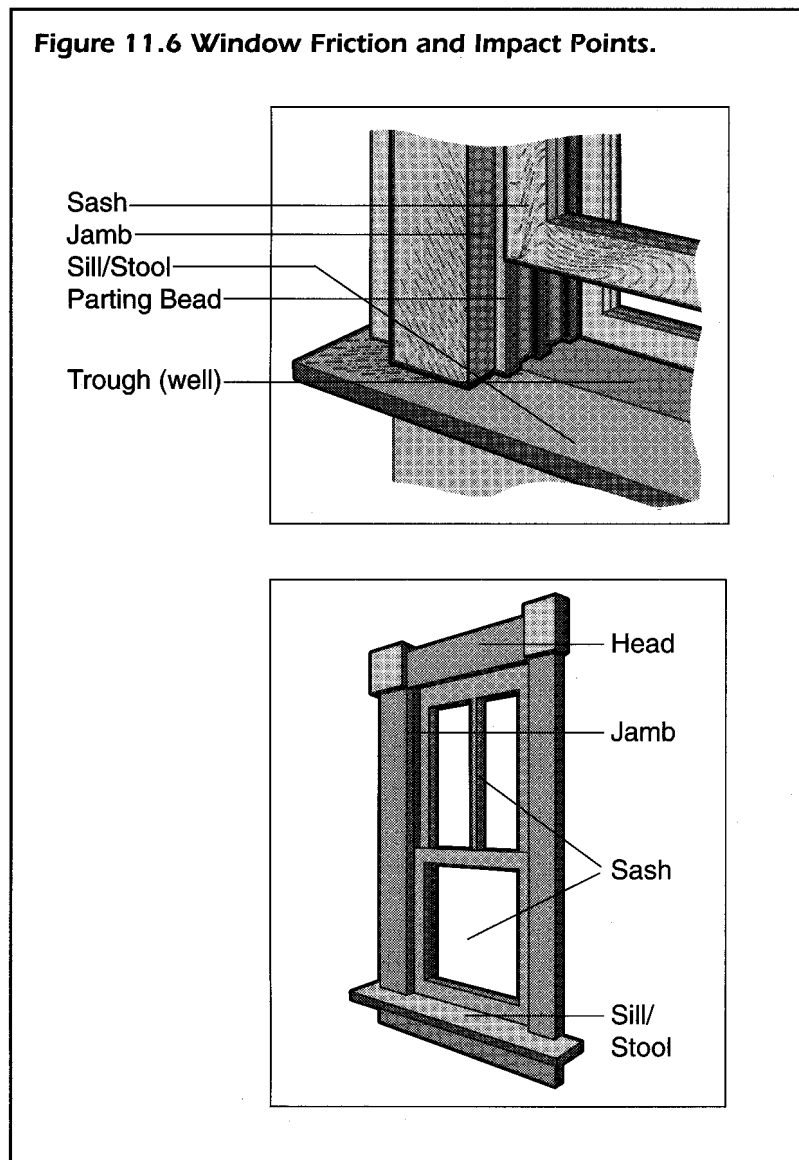

## 2. Impact Surfaces

Impact surfaces are generally protruding surfaces that tend to be bumped or banged. These impacts can cause small chips of paint to become dislodged and fall to the floor, thus covering the floor with small amounts of loose lead-contaminated dust and chips (see Figure 11.7). The most common impact surfaces are doors and doorjamb, door trim, doorstops, outside corners of a wall, baseboards, and shoe moldings along the baseboard, stair risers, and chair rails (see Figure 11.8).

Impact surface problems can be lessened by placing barriers in front of the impact surface, such as new shoe molding in front of baseboards, or a new chair rail to protect lead-based painted walls from jolts by the backs of chairs. Impact surfaces can also be covered with an impact-resistant material (e.g., placing corner beads over outside corners of walls).

### B. Lead Hazard Control Measures

The control measures described in this section involve a combination of both interim control and abatement treatments of windows, doors, stairs, baseboards, drawers, cabinets, porches, decks, and interior floors. These treatments are likely to control lead hazards more effectively and for longer periods than stabilizing painted surfaces.

The treatments described below require special construction and cleanup skills that should be implemented by trained personnel only.

#### 1. Window Systems

Window systems may be the largest source of leaded dust and chips in the home and are also the most complex to treat. Window paint tends to deteriorate more rapidly than other painted surfaces due to moisture, variations in temperature, and exposure to the elements. In addition, painted friction surfaces, including the jamb, stop bead, and parting bead are abraded or "sanded" each time windows are opened and closed. If the wood becomes weathered, dust is trapped and is difficult to remove.

Before beginning any window treatment, the Worksite Preparation Level for windows should be implemented (see Chapter 8).

The stop bead holding in the lower sash should be misted with water and scored with a razor knife along the edges to facilitate its removal. The stop bead should be pried off, wrapped in plastic, and sealed with tape for disposal. Next, the lower sash should be

removed. The jamb, parting bead, sash, window trough, and peeling trim should be misted with water, and loose and flaking paint should be carefully scraped away.

All surfaces should be HEPA vacuumed, paying particular attention to the window trough. If badly weathered, the window trough should be capped with aluminum coil stock (or equivalent), which is back caulked and nailed into place (see Figure 11.9).

All surfaces should be thoroughly scrubbed with a cleaning agent suitable for leaded dust removal and rinsed with clean water. Any necessary repairs to the weight and pulley system should be made at this time. The sash should be reinstalled with a new stop bead and any additional paint loosened by the hammering should be wet scraped. All surfaces should be HEPA vacuumed one more time and the new stop bead should be primed and painted. The plastic used to protect the surrounding area must be misted, folded with the dirty surface inside, and placed in a double 4-mil or single 6-mil plastic bag. The bag should be sealed and labeled to identify the contents for later disposal. Floor surfaces should be HEPA vacuumed beneath the plastic and several feet around the plastic on each side. The floor should be mopped with the cleaning solution, rinsed with clean water, and HEPA vacuumed a final time.

For further protection it is possible to install replacement window channels or slides. Aluminum, vinyl, and polyvinyl chloride (PVC) plastic channels are available (see Figure 11.10).

In this case, both the stop and parting beads should be removed, both sashes taken out, the chain and pulley system disconnected, and the pulleys removed. All other surfaces should receive the same treatment as described above. The jambs should be repainted and the window channels installed with the old sashes and a new interior stop bead.

Covering painted surfaces with coil stock or channel systems is technically an enclosure abatement measure combined with interim controls since the whole window system is not enclosed. This combination of abatement and interim controls provides a great deal of flexibility to the property owner. In many cases it will permit the most cost-effective strategy to be used.

If windows are badly deteriorated, it may be more cost effective to replace them, particularly in young children's bedrooms or in rooms in which young children frequently play.

## 2. Door Systems

Doors present a problem when the doorframe becomes misaligned due to settlement or when multiple coats of paint reduce frame clearance to the point where the door sticks, rubs, or even chips paint on the door or doorstop when opened and closed. The simplest approach is to rehang the door so that it no longer rubs against the doorjamb.

To accomplish this, the area should be protected with plastic taped to the floor, as described in Chapter 8. Heavily painted doorstops can be misted, scored with a razor, and pried loose. The stop should be wrapped in plastic and sealed with tape for disposal. Friction points on the door should be noted. Hinge pins should

be removed and the door carefully planed (preferably outside the unit) to eliminate the friction points. (Note: Planing of doors will generate considerable leaded dust and paint-chip contamination and may be more easily completed offsite in a controlled environment.) The minimum Worksite Preparation Level that should be used is Interior Level 2. A new doorstop, if necessary, should be installed and any paint loosened by the hammering should be wet scraped. The new stop and planed areas should be primed and all surfaces repainted, as described in Section II of this chapter. The floor beneath the plastic and several feet around the plastic should be thoroughly HEPA vacuumed and mopped with a suitable cleaning solution.

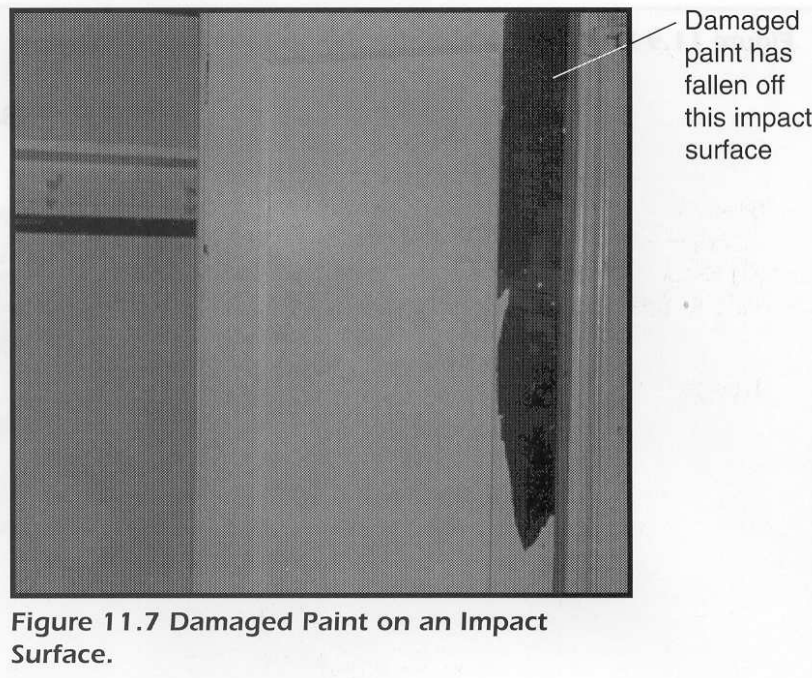

Figure 11.7 Damaged Paint on an Impact Surface.

## 3. Stair Systems

There are a number of treatments that will control lead hazards on stairs. Installation of rubber tread guards will lessen or eliminate friction on the tread (see Figure 11.11). The tread guards should cover the entire width of the stairs.

Covering the treads *and* risers with carpeting can be useful in lessening friction and impact. It is important that carpeting be securely installed and cover the entire width of the stairs, since loose-fitting carpeting can cause abrasion and subsequent dust releases. However, since carpeting is difficult to clean effectively, installation of hard, cleanable surfaces (for example, tile) is generally preferable to carpet.

## 4. Baseboards and Outside Wall Corners

Damage to baseboards subject to frequent impact can be lessened by the replacement of the shoe molding at the bottom of the baseboard (see Figure 11.12). This relatively inexpensive treatment provides a barrier that prevents chair and table legs from actually striking the lead-based painted surface. Shoe molding should be removed by misting the surface, scoring with a razor, and prying the molding loose. The molding should be wrapped in plastic and sealed with tape for disposal. Since the baseboard is not necessarily removed, installation of new molding is a combined abatement/interim control measure. New shoe molding should then be back caulked.

Impact or abrasion of outside corners of walls can be reduced by the installation of a wooden or plastic corner bead (see Figure 11.13).

Figure 11.8 Impact Surfaces.

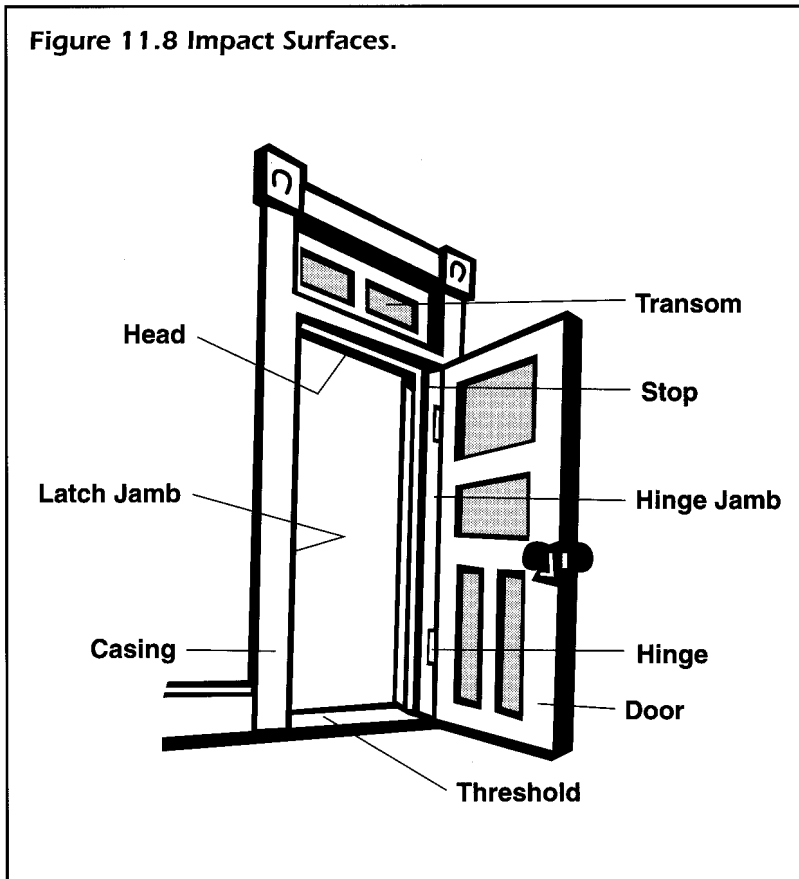
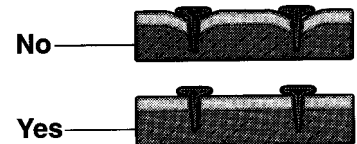
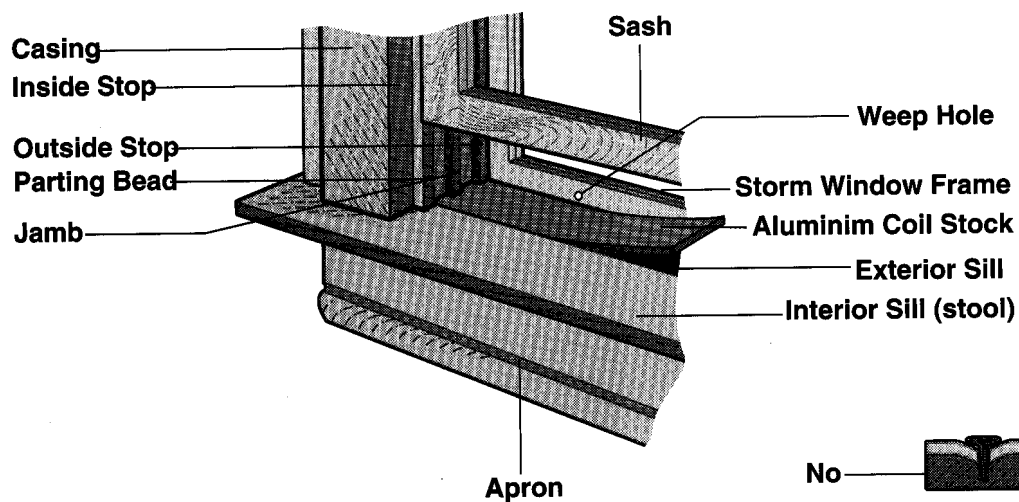
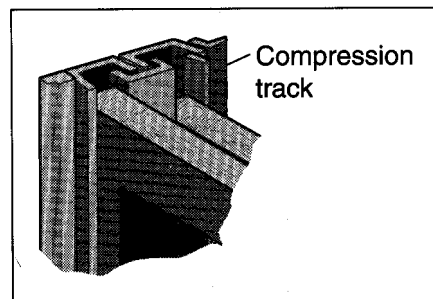
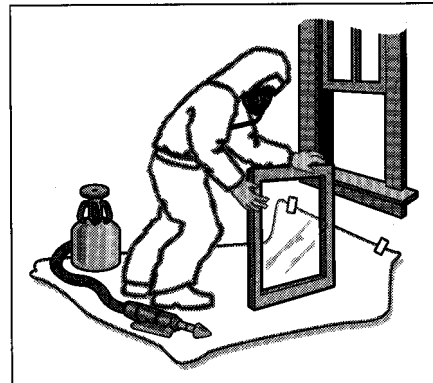

Figure 11.9 Enclose the Window Sill and Window Trough.



**Figure 11.10 Window Channel Guides That Reduce Friction.**

- ◆ Remove the bottom sash. If the counter-weight ropes or chains are in place, do not let them drop into the weight compartment.
- ◆ Remove the paint from edges that rub against stop, stool, and parting bead. Wet planing is a good method.
- ◆ Rehang the sash(es) in a compression track. If there is no counter weight or spring system, install one to keep the sash in place.



**Figure 11.11 Covering Stairs With Tread Guards.**

A rubber tread with metal nosing works well. Rubber nosing that fits snugly on the nose may work if the stairs are not used very often.

- ◆ Enclose risers with thin plywood (like luan plywood) or some other hard material. Whatever you use must fit snugly.
- ◆ Back caulk the edges of treads. Place them and nail or screw them down. Screw or nail the metal nosing on.

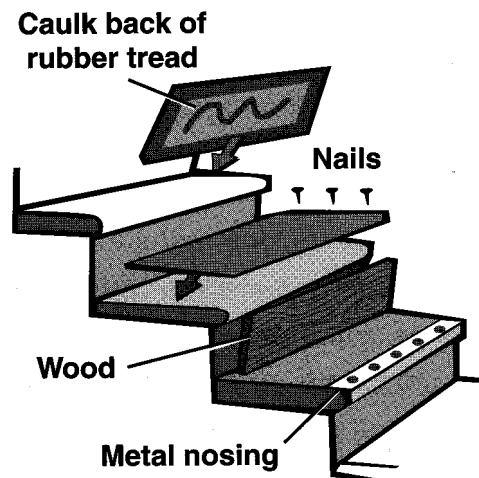

**Figure 11.12 Shoe Molding Is an Acceptable Impact Surface Treatment for Baseboards.**

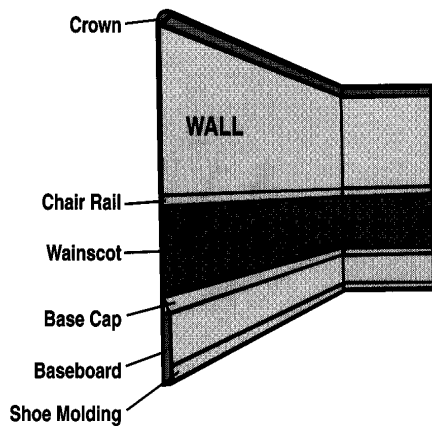

**Figure 11.13 Corner Bead Coverings Can Be Used on Outside Corners of Walls.**

## 5. Drawers and Cabinets

Drawers and cabinets coated with lead-based paint present a potential risk when doors or drawer facings do not fit properly. This is especially important when the cabinet or drawer is used for storing food, eating utensils, or bathroom articles, such as toothbrushes.

Cabinet doors can be carefully removed and discarded, or can be stripped offsite and planed where necessary to fit properly, and repainted. These activities should only be performed after all articles are removed from the cabinet and the immediate area is contained. The exterior and interior of the cabinets should be thoroughly cleaned before articles are returned.

Drawers can also be removed and stripped offsite. Drawer covers can be planed at impact points and repainted. Installation of rubber or felt bumpers will also reduce impact with the painted surface of the cabinet.

## 6. Porches, Decks, and Interior Floors

Porches, decks, and interior floors with lead-based paint can be significant generators of paint chips and leaded dust particles through abrasion or impact. At a minimum, the paint should be carefully stabilized and covered with polyurethane or high-quality paint. Decks and floors must be smooth enough so that dust can be removed by normal cleaning without special equipment. If funds are available, abatement of floors is strongly recommended, usually through enclosure with new flooring or covering.

### C. Lead Hazard Control Measures Performed by Residents

There are also a number of lead hazard control measures that owner-occupants or residents of rental dwellings can carry out. Owners of rental properties should provide residents with educational materials furnished by State or local agencies or lead-poisoning prevention organizations that include the following basic information:

- \* Children's toys should not be placed beneath windows or near surfaces subject to frequent friction or impact.
- \* If there is a sudden loosening of paint material through friction, impact, or any other reason, occupants should use the sticky tape method to remove loose paint described in Table 11.4.
- \* Porch decks, interior floors, and other horizontal surfaces should be wet mopped at least twice a month.



**Table 11.4**  
**Sticky Tape Technique for Removing Loose Paint on Impact Surfaces**  
**for Owner/Occupants or Residents**

---

1. Place a piece of plastic or paper beneath the area in question.
  2. Press a piece of wide sticky tape firmly over the area of loose/chipping paint.
  3. Wait a few seconds and then carefully remove the tape, taking the small chips of paint with it.
  4. Place the tape in a plastic bag.
  5. Carefully fold the piece of plastic or paper that was beneath the area and place it in the bag.
  6. Seal the bag and clean the area.
  7. Dispose of all waste materials in a secure manner; do not use the resident's trash cans for this purpose.
-

## **Step-by-Step Summary**

### **Dust Removal and Control: How To Do It**

1. If the level of lead-contaminated dust exceeds the following levels, the dust should be removed. The present standards for wipe sampling are:
    - \* Window troughs, 800 mg/ft<sup>2</sup>.
    - \* Interior window sills, 500 mg/ft<sup>2</sup>.
    - \* Floors, 100 mg/ft<sup>2</sup>.Bare floors and window components should also be made smooth and cleanable.
  2. Correct any known or suspected lead-based paint hazards before dust removal.
  3. Visually inspect other dust traps, such as radiators and floor grates. If visible dust is found, the component should be cleaned.
  4. Distribute educational materials prepared by EPA or State or local government agencies to residents. These materials should warn residents that carpets, drapes, and upholstered furniture may be contaminated and should be cleaned or replaced.
  5. Prepare the work area with Interior Worksite Preparation Level 1 or other proven containment method (see Chapter 8). If contaminated carpet is to be removed, the work area should be contained with Interior Worksite Preparation Level 3 or 4 (do not put down plastic sheeting on floors for carpet removal).
  6. Clean all horizontal surfaces, beginning with HEPA vacuuming, followed by wet washing with a cleaning agent suitable for lead removal, such as a lead-specific cleaner or trisodium phosphate detergent. Test the cleaning solution before using to determine if it will discolor or damage surfaces to be cleaned.
  7. Begin dust removal at the top rear room in the dwelling, working forward and down. Within rooms, start with the highest horizontal surface and work down. Clean windows, other dust traps, and finally the floors. When practical, clean dirty areas last within rooms to avoid spreading dust.
  8. Place the HEPA vacuum on a smooth, hard surface or on a sheet of plastic during operation. Remove HEPA filters and bags offsite (not inside the dwelling) in a controlled environment.
  9. During wet cleaning, replace rags, sponges, and mops frequently (at least once per dwelling). Use a two-bucket system for floors: one for the cleaning solution and the other for rinsing. Change the wash water at least once in each room.
  10. Clean until no surface dust is visible. After cleaning rinse with clean water and a new sponge or cloth.
  11. The owners of carpets and upholstered furnishings are responsible for their care. Recommend to the owners that highly contaminated or badly worn items should be discarded. To discard a carpet, mist the surface with water; seal in plastic sheeting, bags, or containers; and discard properly.
  12. To clean area rugs, HEPA vacuum the top side with a beater bar or agitator attachment at a rate of 1 minute for each 10-square-foot area. Fold the rug in half and HEPA vacuum the backing of half the carpet without using the beater bar at a rate of 1 minute per 10 square feet. HEPA vacuum the exposed floor beneath the carpet, the bottom of the carpet, and the pad (if there is one), and fold the rug back into its original position. Repeat the process for the other half of the rug. Finally, HEPA vacuum the top side again with the beater bar at a rate of at least 2 minutes per 10 square feet. To summarize:
    - \* Vacuum the top side for 1 minute per 10 square feet.
    - \* Vacuum the bottom for 1 minute per 10 square feet.
    - \* Vacuum the top again for a final 2 minutes per 10 square feet.This is a total of 4 minutes for every 10 square feet of carpeting. Also vacuum the bare floor under the carpet.
-

13. For wall-to-wall carpeting that cannot be folded over, HEPA vacuum at a rate no faster than 2 minutes per 10 square feet in a side-to-side direction, followed by another pass at the same rate in a direction perpendicular to the direction of the first vacuuming, for a total of 4 minutes per 10 square feet. For wall-to-wall carpeting, it is not feasible to clean the floor underneath the carpeting.
14. To attain an even higher level of cleanliness, steam clean the carpet using a regular commercial cleaning system after performing the HEPA vacuuming in step 12 or 13.
15. Conduct clearance dust wipe sampling on rugs or furnishings that were cleaned to determine if the cleaning was effective.
16. To clean other upholstered furnishings, HEPA vacuum each surface three to five times. Steam cleaning is not recommended because it may damage the fabric.
17. Clean drop ceilings or the ductwork for forced air systems only when they are expected to be disturbed. HEPA vacuum and wet clean air vents or registers. Replace air filters in the forced air systems at the time of cleaning.
18. Have a certified inspector technician or risk assessor conduct a clearance examination (see Chapter 15). Repeat cleaning, if necessary. Conduct periodic reevaluations as explained in Chapter 6.

## Section IV

### IV. Dust Removal and Control

#### A. Introduction

Dust removal is a type of interim control that involves an initial treatment followed by recleaning as needed. This section provides information on when the removal of leaded dust (alone) is an appropriate interim control and how to accomplish it. Some dust removal will *always* be an element of interim control measures, either as a stand-alone treatment or as part of cleanup following other work.

#### 1. Sources and Locations of Leaded Dust

Lead in settled house dust is a major source of lead exposure in young children. Leaded dust can come from deteriorating lead-based paint on interior and exterior surfaces, abrasion of lead-based paint on friction and impact surfaces, and the disturbance of lead-based paint during maintenance, renovation, or remodeling activities. Leaded dust can also originate from exterior soil or dust. Sources of lead-contaminated soil include weathering or scraping of exterior lead-based paint, past use of lead additives in gasoline, industrial point sources, and demolition and paint removal from buildings and steel structures. Lead-contaminated soil and exterior dust can be tracked inside by humans and pets or carried indoors by wind. Leaded dust can be produced by activities related to hobbies and can be carried home on the clothing of workers exposed to lead. Table 11.5 provides a summary of potential sources of lead in settled house dust.

Leaded dust can be found on surfaces and in crevices throughout a dwelling. Certain surfaces can act as major reservoirs of lead-contaminated dust, including windows, worn floors, carpets, and upholstered furnishings (see Table 11.6). Cleaning carpets, upholstered items, and worn floor surfaces can be difficult due to embedded dust and dirt. Furthermore, lead-contaminated dust can rapidly reaccumulate on

household surfaces following dust removal (Charney, 1983).

Lead-contaminated dust in carpets and rugs, window coverings (drapes and curtains), mats, and upholstered furnishings is a hazard whether those items are supplied by the owner of the dwelling or by residents. Owners of rental units are responsible for cleaning such items or removing and replacing them only if they belong to the owners. However, the owner should provide residents with educational material furnished by a government agency or a qualified lead-poisoning prevention organization. Such material should include a warning that carpets and rugs, window coverings, mats, and upholstered furnishings may contain dangerous levels of leaded dust and that those items should be thoroughly cleaned or (preferably) removed and replaced if they are hazardous.

#### 2. Removing Leaded Dust From a Dwelling

Both large, visible particles and small particles not visible to the naked eye need to be removed (see Figure 11.14 a and b). Leaded dust can be difficult to remove with ordinary housecleaning measures such as non-HEPA vacuuming, particularly in poorly maintained housing with rough and deteriorated surfaces (Charney, 1983; Farfel and Chisolm, 1987a). A HEPA vacuum is equipped with a special filter that removes nearly all small lead particles from the vacuum's exhaust airstream that would otherwise be redistributed throughout the dwelling.

A combination of HEPA vacuuming and wet cleaning is recommended for leaded dust removal. Wet cleaning is conducted with a solution such as a lead-specific cleaner or trisodium phosphate detergent. Even with special equipment and procedures, leaded dust can be difficult to remove from dust traps, carpets, non-smooth surfaces, and surfaces abated by paint removal methods such as caustic chemicals (Ewers, 1993; Farfel and Chisolm, 1991; Farfel and Chisolm, 1987b).

**Table 11.5**  
**Potential Sources of Lead-Contaminated House Dust**

Source	Process That Contributes to Lead in House Dust	Key Sites
Interior lead-based	Deteriorating paint.	All surfaces.
	Friction/abrasion.	Windows, doors, stairs, and floors.
	Impact.	Door systems, openings, baseboards, corner edges, chair rails, and stair risers.
	Water damage.	Walls, trim, and ceilings.
	Planned disturbances: (maintenance activities, repainting, lead-based paint remodeling, abatement).	All surfaces coated with lead-based paint.
Exterior lead-based paint	Tracking (by humans and pets) and blowing of leaded dust from weathered, chalked, or deteriorated exterior lead-based paint; also direct contact with such paint.	All exterior lead-based painted components, including porches and window sills.
	Demolition and other disturbances of lead-based paint on buildings and nearby steel structures.	Exposed soil, sandboxes, sidewalks, and window troughs.
Soil and exterior dust	Tracking (by humans and pets) and blowing of exterior soil/dirt contaminated with lead from deteriorating exterior lead-based paint; past deposition of lead in gasoline.	Exposed soil, sandboxes, sidewalks, streets, and window troughs.
Point sources	Releases from lead-related industries (i.e., smelters, battery recycling, incinerators).	Location of point sources.
Hobby activities	Cutting, molding, and melting of lead for bullets, fishing sinkers, toys, and joining stained glass. Use of lead-containing glazes and paints. Restoration of lead-based painted items.	Rooms in which hobbies are pursued.
Occupational sources	Transport of lead-contaminated dust from the job to home on clothing, tools, hair, and vehicles.	Vehicles and laundry rooms, changing areas, furniture, and entryway rugs.

Workers and residents removing leaded dust should not spread lead from one household surface to another (cross-contamination). Avoiding cross-contamination requires special knowledge, equipment, procedures, and precautions to protect residents, workers, and the environment. Enhanced routine cleaning procedures and practices as described in this chapter are

recommended for use by property owners over ordinary cleaning practices and procedures. This is not to imply that routine housecleaning is totally ineffective. However, in certain cases, routine housecleaning may need to be augmented by the special procedures detailed in this chapter.

**Table 11.6**  
**Major Dust Reservoirs and Potential Dust Traps**

Interior	Exterior
Window sills Floors/steps Cracks and crevices Carpets and rugs Mats Upholstered furnishings Window coverings Radiators Grates and registers Heating, ventilation, air conditioning filters	Porch systems Window troughs Steps Exposed soil Sandboxes

The cleaning protocol contained in this chapter is different from that used following lead-based paint abatement and other interim control work. Post-abatement cleaning is described in Chapter 14. The main differences are as follows:

\* Only horizontal surfaces (and these vertical surfaces undergoing paint film stabilization, as explained in Section II of this chapter) are cleaned for dust removal; for cleanup following abatement, *all* surfaces are cleaned.

\* A single pass with a HEPA vacuum and wet wash is used for dust removal; for cleanup following abatement, the cycle is HEPA vacuum, wet wash, HEPA vacuum again.

### 3. Creating Cleanable Surfaces and Determining Whether Dust Removal Alone Is Adequate

A risk assessment is recommended to determine whether the removal of leaded dust alone is an appropriate interim control, or whether other interim controls are needed in addition to dust removal. If no environmental testing or risk assessment has been performed, the property owner should assume that lead-based paint is present on all painted surfaces and that all horizontal surfaces have excessive dust lead levels.

The rest of this section will describe how risk assessors and owners should check floors and floor coverings to plan for dust removal activities.

\* **Check condition of floors.** Smooth and intact floor surfaces, such as vinyl or linoleum sheet goods that still have a smooth finish and wooden floors that have a good finish of sealant (e.g., polyurethane or deck paint) can be effectively cleaned. If a floor surface is not smooth or intact, it will require the application of an appropriate sealer or covering and/or repair in order to make it smooth and cleanable. Examples of non-smooth floor surfaces include floors with worn areas or tears; wood floors with gaps, cracks, splinters, and areas with no sealant coating; unsealed concrete floors; and replacement flooring with no finish treatment (e.g., plywood).

\* **Check carpets, rugs, entryways, and mats.** Items such as area rugs or mats should be machine washed. Wall-to-wall carpets and large area rugs in fair to good condition can be cleaned, removed, and discarded or replaced (see section on carpets/rugs below). Consideration should be given to discarding rugs, carpets, and mats that are at the end of their useful lives, since cleaning may not be effective (see below for precautions on removal of carpets) (Ewers, 1993; IDHW, 1991).



**Figure 11.14a Turning a Window Sill and Trough Into a Smooth and Cleanable Surface (before treatment).**

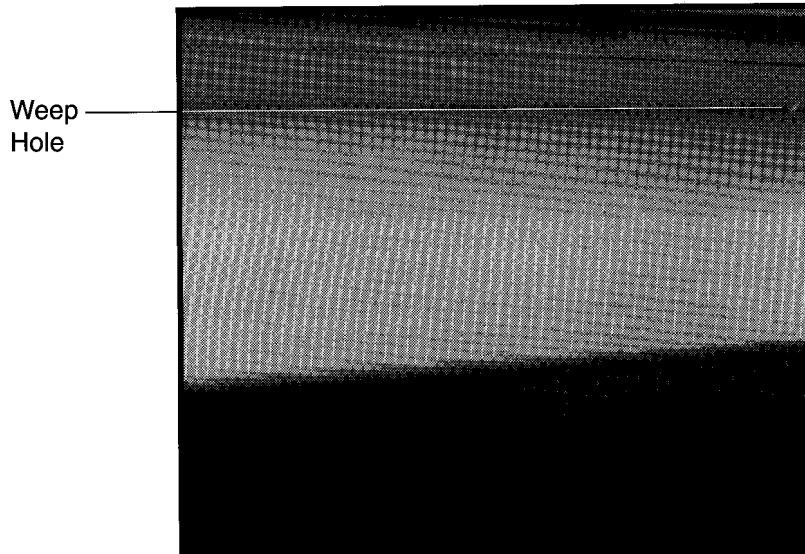

**Figure 11.14b Turning an Exterior Window Sill Into a Smooth and Cleanable Surface (after treatment).**

**Notice Weep Holes Are Left Open to Allow Proper Drainage and Ventilation.**

\* **Check for other potential dust traps.** In addition to carpets, rugs, and mats, potential dust traps include radiators, floor grates and registers, drapes, blinds, and upholstered furnishings. These items should be included in the plan for dust removal. In rental properties some of these items may not belong to the building owner. Owners are responsible for the items they own, while residents are responsible for their own property.

However, it may be in everyone's best interests to include all of these items in the dust removal plan.

#### **4. Planning and Preparations**

Once it has been determined that dust removal is an appropriate approach, the owner should determine if the dwelling unit will be occupied or vacant while the dust removal is occurring. Dust removal work may be

performed by contractors, maintenance staff, or homeowners. Individuals performing the work should be properly equipped and trained in dust removal.

If dwelling units are occupied, the owner should coordinate with residents to ensure that the roles of all involved in the process are clear. The job should be organized so that dust removal work is performed in 1 day to minimize inconvenience to residents. An Interior Worksite Preparation Level 1 is almost always appropriate (see Chapter 8). Additional personnel and equipment may be required to perform simultaneous work in multiple rooms.

**Role of residents.** Owners should provide residents with educational materials prepared by public agencies that indicate how residents can help in removing leaded dust. The materials should indicate that residents perform the following tasks before the professional dust removal occurs:

- \* Wet wash all cleanable toys.
- \* Store all loose personal belongings in boxes, closets, or drawers to provide easy access to floors and other surfaces during dust removal.
- \* Remove drapes and curtains and collect any washable area rugs for cleaning. Clean or arrange for cleaning of these items and store them in sealed plastic bags. Wash blankets known to have been unprotected during renovation or remodeling activity that disturbed lead-based paint.
- \* Wash or dust upholstered furniture using disposable cloths and spray polish.
- \* Change filters in heating and air conditioning units, except where routinely performed by the property manager.

### **5. Responsibilities of Owners**

Owners should perform the following tasks prior to dust removal:

- \* Attempt to schedule dust removal when the dwelling is vacant (such as during unit turnover).
- \* If the unit will be occupied, notify residents of the date dust removal will occur.
- \* Provide a written notice/flyer from the local health agency with information on resident responsibilities for preparation and cleaning.
- \* Provide for the safety of occupants.
- \* Arrange for dust removal of wood or metal components of windows, built-in shelving, radiators, floors, porches, owner-supplied carpets and rugs, window

coverings, mats, upholstered furnishings, and other dust traps.

\* Provide and install cleanable “walk-off” mats at interior entryways. This will help residents control exterior leaded dust that may be tracked into the home (Roberts, 1991).

\* Ensure that dust removal contractors comply with contract specifications. Large multiunit contracts may require an onsite monitor.

\* Obtain written authorization from residents for dust removal where legal authority does not exist for such activity.

\* Arrange for clearance examination.

### **6. Responsibilities of Contractors**

Contractors or maintenance staff should perform the following tasks prior to and during dust removal (City of Toronto, 1990):

- \* Coordinate with residents and owners or managers of property.
- \* Cooperate with any independent, onsite inspector or risk assessor or project monitor who may be present on large, multiunit dust removal projects.
- \* Perform work according to contract/work specifications.

In the case where the owner’s maintenance staff are performing the work, the owner is responsible for the following (otherwise the contractor is responsible):

- \* Ensuring that workers are properly trained and protected (see Chapter 9).
- \* Providing all safety and special cleaning equipment and supplies.
- \* Taking precautions to minimize damage to residents’ belongings.
- \* Moving major furnishings within rooms to facilitate thorough cleaning.
- \* Responding to residents’ questions, complaints, and concerns.

### **B. Methods of Dust Removal**

The objective of any dust removal strategy is to provide a dwelling unit or common area in which the leaded dust levels on all horizontal surfaces are less than the clearance levels. Any cleaning method carried out by a property owner is satisfactory if it meets this performance standard and if workers and occupants are fully protected. The procedures in the following pages describe how best to meet that performance standard.



The dust removal strategy presented in this section focuses effort on horizontal surfaces and dust traps that can have accumulations of surface dust and embedded dust. Embedded dust is dust that is trapped within a fiber matrix (such as carpeting), in cracks and crevices (of wooden floors), under carpets, on greasy surfaces, or ground into surfaces. A combination of vacuuming with a HEPA vacuum and wet cleaning is recommended to remove both surface and embedded leaded dust from household surfaces. For upholstered furnishings HEPA vacuuming alone is recommended.

### 1. Cleaning Hard Surfaces

The standard dust removal procedure for hard surfaces and components (e.g., hardwood floors and window components) is HEPA vacuuming followed by wet cleaning with trisodium phosphate (Milar and Mushak, 1982), or a cleaner designed specifically for lead removal or an equally effective cleaner. One study found that HEPA vacuuming hard surfaces at a rate slower than 1 minute per square meter (approximately 10 square feet) did not remove substantially more leaded dust from hard surfaces than faster methods (Ewers, 1993). Therefore, no speed or time restrictions are necessary for hard surfaces (although such restrictions *are* appropriate for carpeted surfaces, as detailed below).

On hard surfaces HEPA vacuums should be passed over the entire surface with overlapping strokes using normal speed. Trisodium phosphate has been shown to aid in the removal of lead in dust. There is also strong anecdotal evidence that a lead-specific, strip-pable coating (Grawe, 1993) and a lead-specific detergent (Wilson, 1993) are at least as effective as trisodium phosphate in removing lead. These new products may in fact be more effective than trisodium phosphate, which is now banned in some areas. Any cleaning product may be used, as long as the cleaner's performance is evaluated by determining compliance with clearance criteria and lead-specific cleaning

agents. Trisodium phosphate is most likely to permit easy compliance with clearance criteria, avoiding the need for repeated cleaning. Whenever a wet cleaner is used, a small area of the surface should be tested to make sure that it does not damage the surface or its coloring. If so, another wet cleaner should be used.

#### *General work practices*

\* Clean from top to bottom and vacuum before wet cleaning. On multistory dwellings, start at the top level in the rear room and work in one direction toward the front (see Figure 11.15). Then repeat the process on the remaining floors in sequence. Within a room start with the highest horizontal surfaces and work down. This would typically result in the following cleaning sequence: tops of window heads, tops of sashes, mullions, and interior and exterior window sills and troughs. Clean dust traps such as radiators, followed by baseboards, and finally floors, vents/registers, and horizontal components of the ventilation ducts that can be easily reached. When practical, work from clean areas to dirty areas to minimize the spread of leaded dust to clean areas. It is usually not necessary to clean walls and ceilings for dust removal unless those surfaces have undergone paint removal or stabilization.

\* When vacuuming, use crevice and brush tools where appropriate.

\* If possible, place the vacuum unit on a smooth, hard surface that has been cleaned or on a clean sheet of 6-mil plastic rather than on a carpet. Vacuum exhaust, even on HEPA vacuums, can disperse dust when the exhaust airstream disturbs settled dust on a surface. A HEPA vacuum that exhausts air from the top or side rather than the bottom helps to minimize dust dispersal, making it unnecessary to use a sheet of plastic.

\* Use disposable cleaning cloths or sponges. Be prepared to dispose of them during the cleaning process and replace with new ones.

Figure 11.15 Sequence for Dust Removal.

#### How to use a HEPA vacuum

1. Lightly mist area with water to keep dust levels down.
2. HEPA vacuum all horizontal surfaces.

Start at the end farthest from the main entrance/exit. As you vacuum, move towards the main exit and finish there.

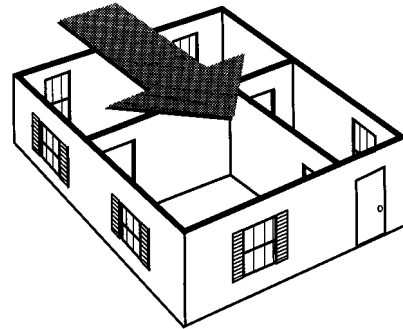

Begin at the top of each room and work down. For example, start with the top shelves, the top of the woodwork, and so on, and work down to the floor. Do every inch of the windows, especially the window troughs.

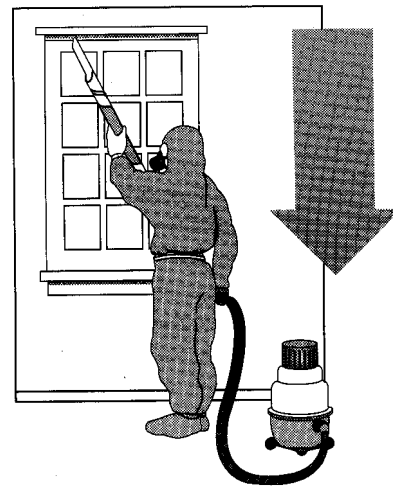

\* When cleaning household surfaces other than floors, the cleaning solution may be mixed in a plastic jug and poured directly onto sponges or cloths (EPA, 1992a). This procedure is designed to minimize the contamination of the cleaning solution with leaded dust. Frequently rinse the sponge/cloth in a bucket of clean water.

\* For floors a two-bucket system is strongly recommended to minimize the potential for spreading leaded dust from one location to another. The cleaning solution should be mixed in one bucket; a second bucket should contain rinse water for the mophead. Frequently, at least once per room, change the rinse water in the bucket. A disposable sponge mophead with a built-in wringer (rather than a string mop) is recommended. A final cosmetic rinse is recommended using clean water or a commercial cleaning solution.

\* Clean until surface dust is no longer visible. After cleaning a window or a floor, rinse with clean water using a new sponge or cloth.

\* To make a cleaning solution with trisodium phosphate or other suitable detergent, mix with water according to the manufacturer's instructions for recommended concentrations. When using the cleaner (especially trisodium phosphate), wear gloves and eye protection gear and follow all manufacturer's instructions and precautions. OSHA regulations require an onsite eyewash station when using trisodium phosphate (29 CFR 1910.151). Also, concentrated trisodium phosphate solutions can damage and discolor some surfaces.

\* Where possible, clean floors underneath rugs and carpets.

\* For dust removal projects in multifamily housing, a truck-mounted vacuum unit with a HEPA filter exhaust may be preferable since the exhaust stream is located outside the dwelling and therefore is not likely to disturb dust inside the dwelling.

\* Remove and dispose of HEPA vacuum cleaner bags and filters offsite, according to the manufacturer's instructions, in a controlled environment capable of capturing any dust released by the procedure. If the filters need to be changed in the middle of the job, take the vacuum unit outside the house, place it on a sheet of plastic, and remove the old filter carefully. Do not change filters inside the dwelling if possible (see Figure 11.16 a-f).

## 2. Removal or Cleaning of Carpets or Rugs

Carpeting and large area rugs can be major traps and reservoirs of leaded dust. Dirt embedded in fibers of carpets and rugs is not easily removed by cleaning. The procedures described in this section have been shown to reduce lead levels to a limited degree. Highly effective lead removal methods have yet to be identified (Ewers, 1993; IDHW, 1991). It is not likely that any cleaning process will remove all leaded dust embedded in carpets.

The first step in carpet dust removal is to decide if the carpet is going to be cleaned onsite, removed for disposal, or removed for professional offsite cleaning. It may be preferable to dispose of carpets that are in poor condition or those known to be highly contaminated with lead.

In fact it may be more costly to clean a lead-contaminated carpet or rug than to replace it. When carpets are removed, the precautions described below should be followed to minimize the exposure of workers and residents to leaded dust.

Removal of carpets or rugs. When a carpet or rug is going to be removed from a dwelling for either disposal or offsite cleaning, the following procedure is recommended:

Mist the entire surface of the carpet to keep dust from spreading. Carefully roll up the carpet along with any padding. (If the padding is not going to be removed, clean it like an area rug.) Wrap the carpet in a sheet of plastic, seal it with tape, and remove it from the dwelling.

Because the removal of a carpet may generate significant amounts of airborne lead-contaminated dust, Interior Worksite Preparation Level 3 or 4 is recommended. If the area in which the carpet is located is not fully contained, HEPA vacuum the floor after removing the carpet so leaded dust is not tracked to other parts of the dwelling.

Cleaning area rugs. If cleaning of large area rugs is done onsite, the following steps are recommended:

\* First, vacuum the pile side (the top side) with a HEPA vacuum equipped with a beater bar or agitator attachment on the vacuum head at a rate no faster than 1 minute for every 10 square feet. The purpose of the beater bar is to dislodge embedded dust (CMHC, 1992; Ewers, 1993; IDHW, 1991).

\* Fold the rug in half, exposing the backing of half of the carpet. The backing of the carpet should be HEPA vacuumed without using the beater bar attachment (City of Toronto, 1990) at a rate of 1 minute per 10 square feet.

\* Vacuum the exposed floor beneath the rug at normal speed and unfold the rug.

\* Fold the rug in half again, exposing the backing of the other half of the carpet, and repeat the HEPA vacuuming of the bottom of the rug and the floor underneath.

\* Unfold the rug.

\* HEPA vacuum the pile side of the rug again using the beater bar attachment. Vacuum at a rate no faster than 2 minutes per 10 square feet.

Consideration should be given to a final cleaning step consisting of a steam cleaning of the pile side of the rug. Steam cleaning can remove additional, but limited, amounts of lead from rugs (IDHW, 1991). This cleaning can be done by the contractor, owner, or resident using commercially available equipment. For multiunit buildings consideration should be given to the use of truck-mounted cleaning equipment since it may be significantly more powerful than typical rental equipment for residential use.

Phosphate-containing detergents may be more effective than nonphosphate-containing, regular detergents when cleaning rugs (Milar and Mushak, 1982), although the new lead-specific cleaners have not yet been evaluated for carpets. If using a commercial cleaning detergent that does not contain phosphate or a lead-specific removal agent, consideration should be given to substituting a mild trisodium phosphate or lead-specific solution (less than half the recommended strength). It may be necessary to clean a small, inconspicuous area first to determine if the material is colorfast. In all cases a second cleaning with the regular commercial cleaner is recommended. New cleaners advertised as lead-specific can also be used since preliminary evidence indicates that they are successful (Grawe, 1993; Wilson, 1993).

Cleaning wall-to-wall carpeting. For cleaning wall-to-wall carpeting, the following procedure is recommended:

Vacuum carpeting with a HEPA vacuum equipped with a beater bar or agitator attachment on the vacuum head. The beater bar helps to dislodge embedded dust. The total vacuuming time recommended is at least 4 minutes per 10 square feet of carpeting (Ewers *et al.*, 1993), divided into two segments of at least 2 minutes for each 10 square feet. The two vacuuming segments are performed in perpendicular directions. For example, the first segment may be done in an east-west direction, while the second is done in a north-south direction.

The provisions regarding steam cleaning and suitable detergents for area rugs also apply to wall-to-wall carpeting.

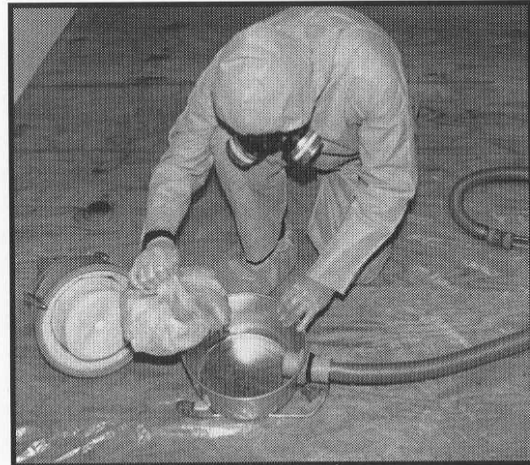

**Figure 11.16c Remove Bag.**

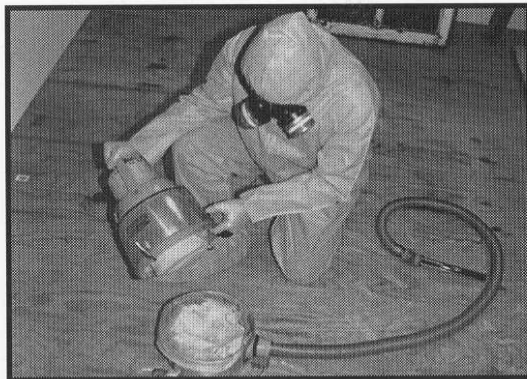

**Figure 11.16a Remove the HEPA Vacuum Filters and Disassemble the Vacuum With a Plastic Sheet Underneath.**

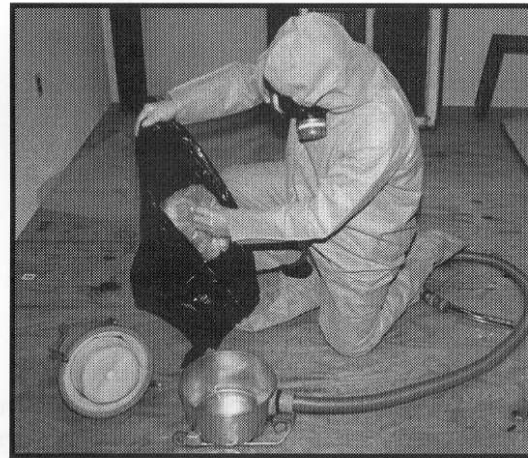

**Figure 11.16d Tape Vacuum Bag Closed and Put Inside Plastic Trash Bag.**

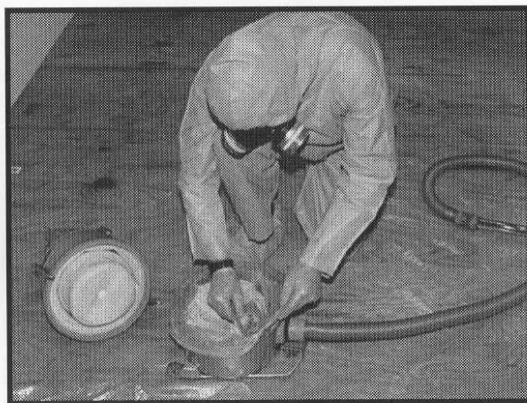

**Figure 11.16b Disconnect Vacuum Bag From Hose Inlet.**

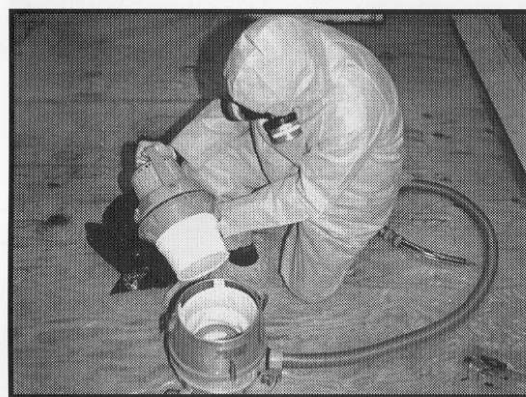

**Figure 11.16e Wash or Replace Coarse Prefilters if Necessary.**

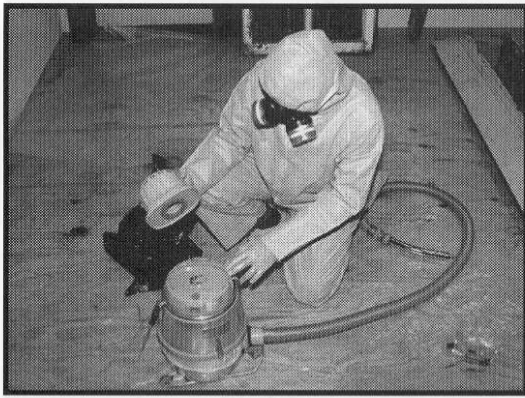

**Figure 11.16f Remove and Replace HEPA Filter Assembly.**

### 3. Cleaning Upholstered Furniture

The first step in dealing with upholstered furnishings is to determine if the item is going to be discarded or cleaned. It may be preferable to dispose of items that are in poor condition or known to be highly contaminated with lead.

The recommended dust removal procedure for upholstered furniture is HEPA vacuuming without steam cleaning or other wet cleaning procedures that could damage fabrics. Cloth throw covers, slipcovers, or fitted vinyl covers should be provided for all cleaned, upholstered items. This is particularly important for items at the end of their useful lives that would not hold up well under an aggressive vacuuming. A cloth cover material that can be easily removed and washed should be selected.

Upholstery surfaces should be HEPA vacuumed with three to five passes over each surface at a total rate of 2 minutes per 10 square feet.

### 4. Forced Air Systems and Drop Ceilings

This section provides a practical approach to dealing with these potential dust reservoirs. At the present time, it is not known whether leaded dust in forced air ducts and drop ceilings is a hazard to residents. Although one study has measured leaded dust in air

ducts (city of Toronto, 1990), the results do not provide evidence that the lead is leaking out of the ducts and posing a hazard to children. If the ceilings or forced air systems contain leaded dust, they may present a hazard to maintenance or renovation workers who access them.

Where possible, return and supply air vent registers that can be easily removed should be taken out, vacuumed, and wet cleaned (see Figure 11.17). If the vent registers are sealed to the wall or floor with paint, the edges should be misted and scored to help free the vent register with a minimum of leaded-dust generation.

Air vent registers that cannot be easily removed should be vacuumed and wet cleaned in place. The horizontal surfaces in the ductwork that can be easily reached with the vacuum attachment can be cleaned. Water should not be poured down the air duct to clean the vent register; wiping with a damp sponge or mop is adequate.

Replace the air filters on heating units and air conditioners with new filters at the time of dust removal. Used filters should be placed in plastic bags and sealed prior to disposal to minimize the potential spread of leaded dust.

Leaded dust in nonforced air systems and drop ceilings is not considered a hazard to residents unless major disturbances of the ducts or ceilings are planned, such as repairs or relocations of ducts. When major disturbances of any type of duct or ceiling work are anticipated, cleaning will probably be warranted. This includes instances when forced air systems have the direction of airflow reversed during maintenance.

### 5. Resident Protection

To facilitate dust removal work and provide protection for occupants, only workers should be in the work area during the dust removal process. This will also help ensure that work can be completed in 1 day. The work area is defined as the room in which dust removal is occurring or where preparations are being made for dust removal. Interior Worksite Preparation Level 1 is usually adequate for dust removal unless lead-contaminated carpets or area rugs are being removed.

Figure 11.17 Clean Air Vents Registers.

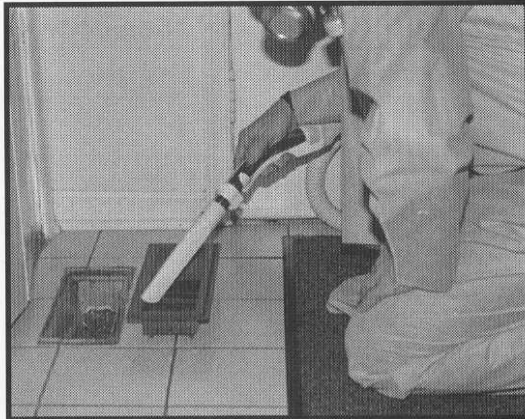

a. Vacuum and Remove Register Covers.

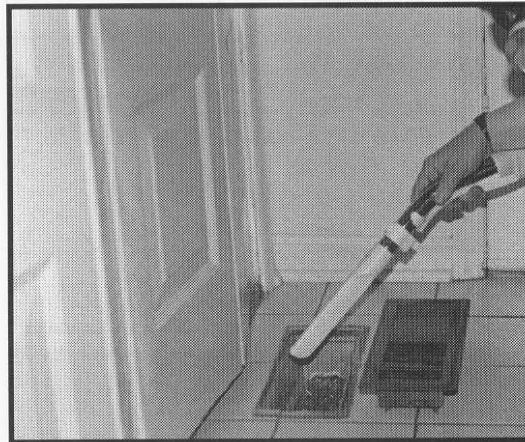

b. Vacuum Accessible Parts of Duct Opening.

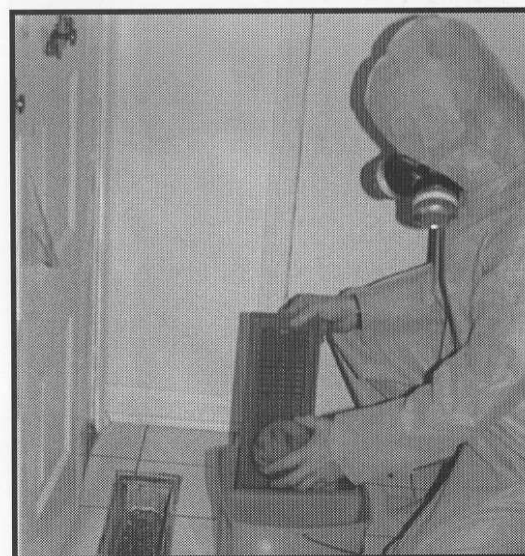

c. Wet Wash Register Covers and Replace.

### C. Followup to Dust Removal

Inspectors or risk assessors performing clearance examinations should check to see that all visible dust and dirt have been removed from the dwelling, followed by dust sampling. (See Chapter 15 for information on clearance.) The clearance test results will provide a means of checking that lead levels have been reduced by the dust removal work and will serve as a baseline for comparison to future test results.

**Table 11.7**  
**Carpet Cleaning Steps**

Step	Description	Time/10 ft <sup>2</sup>
1	HEPA vacuum with beater bar at a rate no faster than 1 minute for every 10 square feet.	1 minute
2	Fold rug in half and HEPA vacuum bottom of rug without beater bar at a rate no faster than 1 minute per 10 square feet.	1 minute
3	HEPA vacuum bare floor and any padding (no rate restriction or beater bar).	Approximately 10-30 seconds
4	Fold other half of rug over and repeat steps 2 and 3 (no rate restriction and no beater bar).	Approximately 10-30 seconds
5	Fold rug back over so it is in its original position.	Approximately 10-30 seconds
6	HEPA vacuum top side of rug a final time with the beater bar. The rate is no faster than 2 minutes per 10 square feet.	2 minutes
<b>Total Time</b>		<b>4.5-5.5 minutes</b>

Since it has been shown that lead-contaminated dust can reaccumulate on household surfaces following lead-based paint abatement and dust removal alone (Charney *et al.*, 1983; Farfel and Chisolm, 1987b; Jacobs, 1992; Clark, 1993), ongoing monitoring and professional reevaluation of the dwelling, resident education, and continued cleaning are important elements of a dust removal plan.

Educational materials prepared by State or local government agencies or lead-poisoning prevention organizations should explain the need for periodic wet cleaning of household surfaces, with particular attention to dust traps and reservoirs, and the importance of promptly informing property owners or managers of needed repairs. Those materials should include instructions for proper replacement and disposal of air conditioning and heating unit filters. Some owners and municipalities provide cleaning kits to residents to encourage and support their ongoing dust removal efforts. (See Chapter 2 and Section I of this chapter for information on resident education.)

In addition, easily cleaned walk-off mats should be placed at entryways to control the tracking of leaded dust into the dwelling (see Figure 11.18).



**Figure 11.18 Walk-Off Mats.**

## **Step-by-Step Summary**

### **Soil Interim Control: How To Do It**

1. Determine if lead contamination exists by taking samples of bare soil. The soil should be considered contaminated if lead levels exceed 2,000 µg/g (pending an Environmental Protection Agency standard) in the yard or the building perimeter, or 400 µg/g in high-contact play areas. If bare soil levels are high (greater than 5,000 µg/g), interim controls are not appropriate. At least a total of 9 square feet of contaminated bare soil must exist in each yard or building perimeter for a hazard to be identified.
2. Use water to contain dust and clean equipment to prevent dispersion of lead.
3. Select an appropriate soil interim control, which may include impermanent surface coverings or land use controls.
4. Impermanent surface coverings, including grass (as seed or sod), other ground covers (e.g., ivy), artificial turf, bark, mulch, and gravel, may not be permanent. If the area to be controlled is heavily traveled, surface coverings such as grass are not appropriate.
5. If grass is selected, consult with the local agriculture extension service or a reputable local nursery to determine what grasses are appropriate for the locale, soil type, and sun/shade characteristics. Properly prepare the soil prior to seeding or sodding.
6. If bark or gravel is selected, apply the covering at least 6 to 12 inches deep. New bark, gravel, or other materials should not contain more than 200 µg/g of lead. These materials should be tested before use unless previous testing data are available.
7. If the soil is in a public recreation area, comply with Consumer Product Safety Commission standards on acceptable surface coverings in play areas.
8. Land use controls include fencing, warning signs, creation of alternative play areas (such as decking), and thorny bushes.
9. Install surface coverings and/or land use controls. For live ground covers (including grass), it is imperative that they are properly watered during the first 3 months and adequately maintained thereafter. Automatic sprinkler systems are appropriate for large properties.
10. Control water erosion by proper grading and installation of drainage channels (drainage channels may need to be fenced if they are accessible).
11. Control wind erosion by periodic watering, windbreaks, or foot-traffic controls.
12. Provide walk-off doormats at all entryways to reduce the tracking of contaminated dust and soil into the dwelling.
13. Have a certified risk assessor or inspector technician conduct a clearance examination and provide the necessary documentation.
14. Perform ongoing maintenance and monitoring of soil coverings and land use controls. Reevaluations of the surfaces should be conducted by a certified risk assessor or inspector technician based on the specific reevaluation schedule for that property.
15. If ongoing monitoring or reevaluations show that bare soil remains or reappears, interim controls are not effective. Soil abatement should be conducted (see Chapter 12), unless other interim controls can be shown to be feasible for the specific site.



## Section V

### V. Soil Interim Controls

#### A. Temporary and Permanent Soil Treatments

Interim control measures for lead-contaminated soil include surface coverings with grass, gravel, or similar materials, or land use controls, such as fences, thorny bushes, or decks, for preventing contact with the contaminated soil. These interim controls are designed to temporarily reduce exposure. How long they remain effective depends on many factors, including the durability and maintenance of the cover, degree of foot traffic, and climate.

Permanent soil abatement measures are covered in Chapter 12, Section V. If the control measure includes a permanent cover, such as asphalt or concrete, the method is classified as an abatement, whereas a temporary cover would constitute an interim control measure. If the soil contains very high amounts of lead (greater than 5,000  $\mu\text{g/g}$ ), permanent abatement strategies should be used.

#### B. Types of Interim Control Measures for Soil

Four categories of measures may be used as part of an interim control plan for soil. These are:

- \* Measures that alter the contaminated soil.
- \* Measures that alter the surface cover.
- \* Land use controls.
- \* Measures to reduce offsite transport of the contaminated soil.

Each of these activities should be carried out in a manner that prevents further dispersion of the contamination and prevents the area undergoing the interim control treatment from being contaminated in the process. Work practices for soil interim controls are similar to those for soil abatement and are described more fully in Chapter 12, Section V.

#### 1. Altering Contaminated Soil

Interim controls usually involve only minimal alterations to the soil. The installation of grass or other plantings, for example, will often involve surface cultivation or addition of a thin layer of new soil (no more than 3 inches) in order for the ground cover to become established.

#### 2. Soil Surface Cover

A second interim control method involves adding a surface covering that will act as a barrier between the bare, lead-contaminated soil and people and pets. Various types of surface coverings may be considered, including:

- \* Grass (either through seeding or planting of sod).
- \* Other live ground covers (e.g., juniper shrubs, ivies).
- \* Artificial turf.
- \* Bark.
- \* Gravel.

The choice of a covering for a particular area depends on the climate, expected use, planned maintenance, and aesthetic preferences. For aesthetic as well as practical reasons, a property owner may choose to improve the surface cover over an entire soil area even though only a portion is bare.

The success of grass and other live ground covers is dependent on proper planting, regular maintenance, and most importantly, the ability to control the use of the area. In high-traffic areas use of grass as an interim control is unlikely to succeed. Other surface coverings such as artificial turf may be more appropriate. Where access to an area can be controlled, or where use is expected to be limited, grass and other live ground covers can be successful interim controls. Some ground covers, such as juniper bushes, can also effectively limit traffic through an area.

**Table 11.8**  
**Grasses and Their Appropriate Applications**

<b>Grasses That Grow From Seeds</b>	<b>Texture</b>	<b>Climate</b>	<b>Durability</b>
Bahia grass	Coarse	Warm	Excellent
Colonial Bent grass	Fine	Cool	—
Creeping Bent grass	Fine	Cool	—
Common Bermuda grass	Medium to Fine	Warm	Excellent
Kentucky Bluegrass	Fine	Cool	—
Rough–Stalk Bluegrass	Fine1	Cool	Poor
Centipede grass	Medium to Fine	Warm	—
Dichondra	Coarse	Warm	—
Chewings Fescue	Fine	Cool	Poor
Creeping Red Fescue	Fine	Cool	Poor
Hard Fescue	Fine	Cool	—
Tall Fescue	Coarse	Cool	Moderate to Excellent
Annual Ryegrass	Coarse	Cool	—
Perennial Ryegrass	Fine	Cool	Excellent
<b>Grasses That Grow From Sod</b>			
Bahia grass	Coarse	Warm	Excellent
Hybrid Bermuda grass	Fine	Warm	Excellent
Kentucky Bluegrass	Fine	Cool	—
Centipede grass	Medium to Fine	Warm	Poor
Dichondra	Coarse	Warm	—
Tall Fescue	Coarse	Cool	—
Seashore Paspalum	Medium	Warm	—
Perennial Ryegrass	Fine	Cool	Excellent
St. Augustine grass	Coarse	Warm	—
Zoysia grass	Fine	Warm	Excellent

Before using grass or live ground covers as an interim control measure, a property owner should consult with a lawn care professional about soil preparation, appropriate grasses and plants to use, and future maintenance requirements. The county cooperative extension service or a reputable local nursery may be contacted for advice on types of grass to be used in specific geographic areas and for specific soil types, slope, and sunlight conditions. Table 11.8 offers a brief summary of grass types and their suggested uses. The local office of the U.S. Department of Agriculture Soil Conservation Service may also be able to provide advice about soil conditions in a specific geographic area. An owner of a large property may consider installing a sprinkler system to improve the maintenance effort. In any event some type of hose and sprinkler system should be made available.

When planting grass an owner should consider whether sod or seeding is more appropriate. Both grass seed and sod require restrictions on foot traffic until root systems and stems become established. Newly laid sod requires at least 2 weeks, while grass seed requires 1 to 2 months (Lane Publishing, 1989; Maryland Extension Service, 1993). Sod can be laid during most of the year (as long as the ground is not frozen) and requires less initial care. However, sod is more expensive than seeding and is less likely to develop the deep root systems that will allow the grass to withstand regular wear and tear. It is best to lay sod during the growing season.

At least 6 inches of bark or gravel are necessary to serve as a temporary ground covering (see Figure 11.19). There are anecdotal reports of high lead levels

in replacement bark. Bark should be tested by laboratory analysis before use, unless it has been tested previously. Bark should not be used if it contains more than 200 µg/g of lead.

Bark or other suitable soft material should be used as surface cover for contaminated soil near play equipment. This will offer a degree of protection from injuries that may result from falling. Consumer Product and Safety Commission regulations dealing with acceptable surface coverings in play areas may apply to public areas (CPSC, 1991). Decking can also be used to reduce a child's contact with soil, although pets should be kept off the decking. Artificial turf can also be used, but may cause drainage problems if it is not permeable.

Rubber cushioning specifically designed for playgrounds can also be used to cover contaminated, bare soil in play areas.



Figure 11.19 Bark Used as an Interim Control.

### 3. Land Use Controls

To temporarily reduce human exposure to bare, contaminated soil, the following land use control measures may be considered:

- \* Fencing.
- \* Decks.
- \* Warning signs.
- \* Creation of alternative play areas for children.

- \* Removal of play equipment from bare areas.
- \* Educational efforts.
- \* Planting thorny or dense bushes (see Figure 11.20).

Preventing access to the bare, contaminated soil by fencing is most effective if other entrances and exits to the housing units can be maintained for use by residents, guests, commercial vehicles, and emergency vehicles (see Figure 11.21 a and b). Fencing may also be used to reduce exposure during a delay in the implementation of other interim control measures or soil abatement.

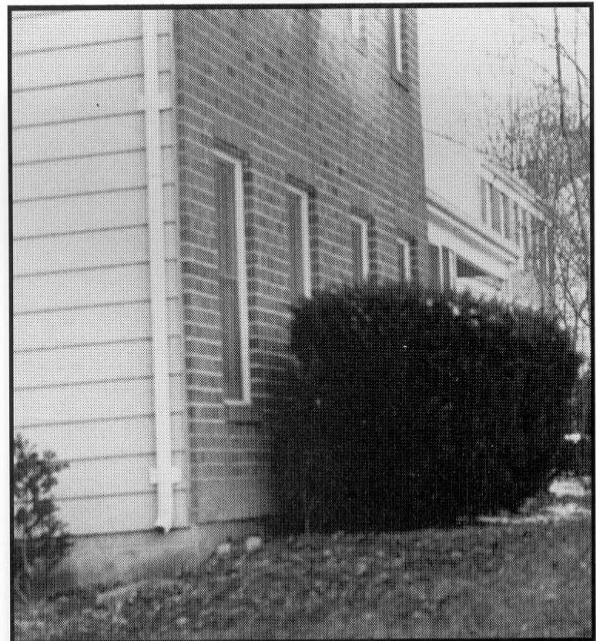

Figure 11.20 Thorny Bushes as a Land Use Control.

Educational efforts directed towards decreasing use of bare, lead-contaminated areas; avoiding eating or drinking in these areas; and frequent washing of hands may serve to reduce ingestion of the contaminated soil. The decision on whether to plant grass or erect barriers should be site-specific and should consider the availability of alternative play areas, the location of contaminated soil with respect to entrances or exits, the likelihood that leaded dust may be tracked onto sidewalks or directly into the housing unit, the degree of supervision available, and local preferences.

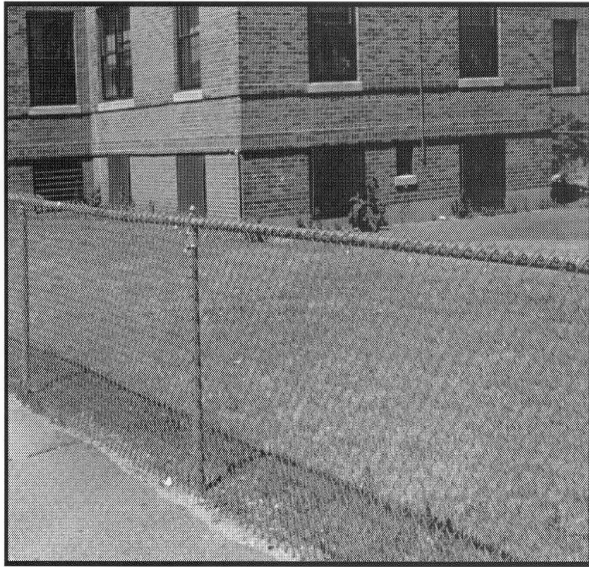

Figure 11.21a Fencing as a Soil Interim Control.



Figure 11.21b Fencing as an Interim Control for Bare Soil Hazards.

#### **4. Drainage and Dust Controls**

Drainage controls may involve directing water flow away from the contaminated areas by alterations in adjacent grades and/or installation of drainage channels. Drainage channels that receive runoff from bare, contaminated soil areas may need to be fenced to reduce access. Dust generation can be reduced by periodic watering, the creation of windbreaks, or foot traffic controls.

#### **C. Controls to Minimize Migration of Soil Lead into Dwellings**

Doormats can be used to minimize the entry of soil lead into the house. Doormats should be placed on the exterior and immediate interior of the entry doors. Mats should be cleaned by machine washing or other wet methods, not by beating or sweeping. (See Section V of this chapter for further information.)

Removing shoes at the doorway also greatly minimizes the amount of leaded soil and dust tracked into the house.

#### **D. Monitoring and Reevaluating Soil Interim Controls**

If grass or sod is planted, or if bark, gravel, or other similar covering is used, it should be monitored visually. The monitoring should occur frequently immediately after installation and can be reduced thereafter.