

Chapter Comm 82

APPENDIX

The material contained in this appendix is for clarification purposes only. The notes, illustrations, etc., are numbered to correspond to the number of the rule as it appears in the text of the code.

A-82.11 (29) BRANCH INTERVALS

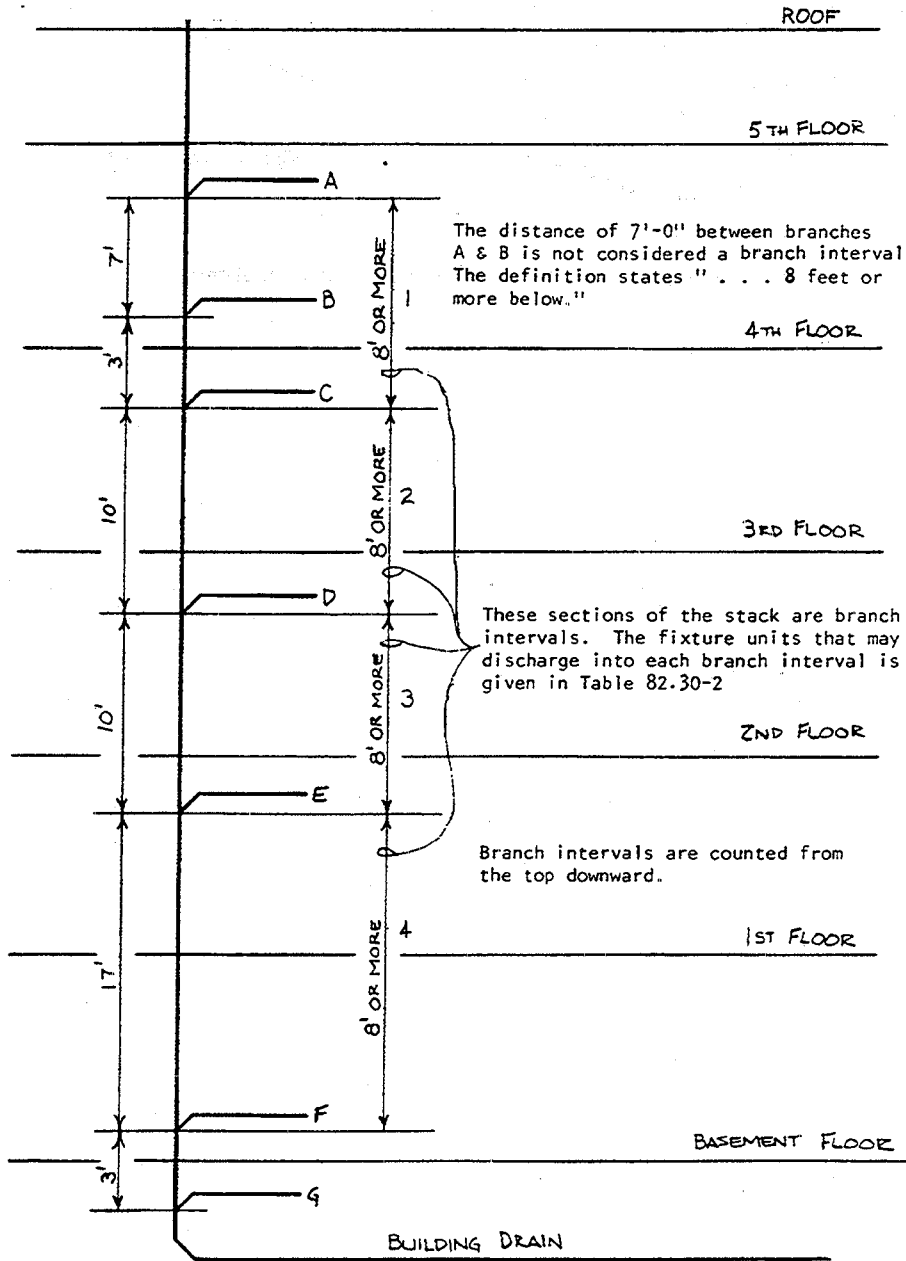

A-82.11 (140) SPRINGLINE OF PIPE

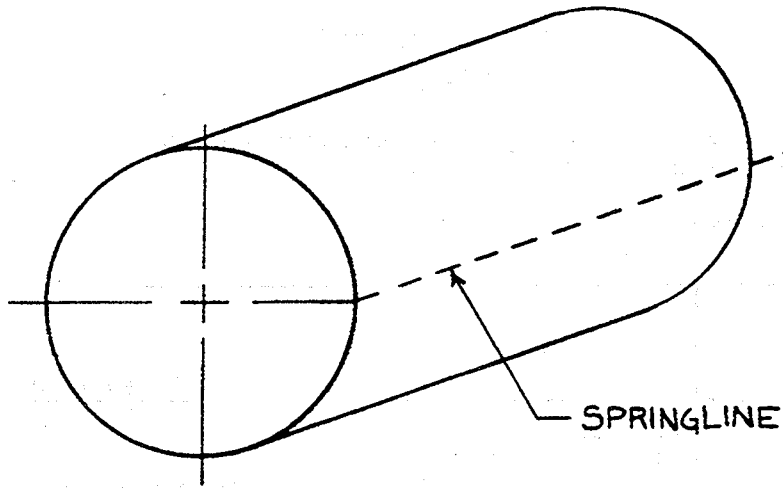

On a round pipe the springline is along the horizontal centerline.

**A-82.20 (2) AGENT MUNICIPALITIES.** The department has designated to the following municipalities, the authority to review and approve plumbing plans and specifications for those plumbing installations to be located within the municipality's boundary limits and which require approval under s. Comm 82.20 (1) (b).

Appleton  
100 N. Appleton Street  
Appleton, WI 54911-4799  
(414) 832-6411

Eau Claire  
203 South Farwell Street,  
Eau Claire, WI 54701  
(715) 839-4947

Green Bay  
100 N. Jefferson St., Rm. 403  
Green Bay, WI 54301  
(414) 448-3295

Greenfield  
7325 W. Forest Home Ave.  
Greenfield, WI 53220  
(414) 543-5500

Janesville  
P. O. Box 5005  
Janesville, WI 53547-5005  
(608) 755-3064

Kenosha  
Dept. of Housing  
625 52nd St., Rm. 100  
Kenosha, WI 53140  
(414) 658-4263

Madison  
P. O. Box 2984  
Madison, WI 53701-2984  
(608) 266-4568

Milwaukee  
Municipal Bldg., Rm. 1017  
841 N. Broadway Street  
Milwaukee, WI 53202  
(414) 286-3364

Oshkosh  
215 Church Ave.  
Oshkosh, WI 54901  
(414) 236-5052

Racine  
730 Washington Ave.  
Racine, WI 53403  
(414) 636-9164

Sheboygan  
City Hall - 3rd Floor  
828 Center Ave.  
Sheboygan, WI 53081  
(414) 459-3479

Two Rivers  
P. O. Box 87  
Two Rivers, WI 54241  
(414) 793-5580

**A-82.20 (4) PLANS AND SPECIFICATIONS.** The following is a list of water quality management agencies and the areas they serve.

**AGENCY**

East Central Wisconsin Regional Planning Commission  
132 Main Street  
Menasha, WI 54952  
(414) 751-4770

Dane County Regional Planning Commission  
217 South Hamilton, Room 403  
Madison, WI 53703  
(608) 266-4137

Brown County Planning Commission  
100 N. Jefferson Street, Room 608  
Green Bay, WI 54301  
(414) 448-3400

Southeastern Wisconsin Regional Planning Commission  
916 North East Avenue  
P. O. Box 1607  
Waukesha, WI 53187-1607  
(414) 547-6721

West Central Wisconsin Regional Planning Commission  
800 Wisconsin Street, Mailbox 9  
Eau Claire, WI 54703-3606  
(715) 836-2918

St. Croix County Planning Office  
1101 Carmichael Road  
Hudson, WI 54016  
(715) 286-4673

Bay-Lake Regional Planning Commission  
211 N. Broadway, Suite 211  
Green Bay, WI 54303  
(414) 448-2820

**AREAS SERVED**

Counties of Menominee, Shawano, Waupaca, Outagamie, Waushara, Marquette, Green Lake, Winnebago, Calumet, Fond du Lac

County of Dane

County of Brown

Counties of Washington, Ozaukee, Waukesha, Milwaukee, Walworth, Racine, Kenosha

Cities of Eau Claire, Altoona, Chippewa Falls  
Towns of Hallie, Seymour, Union, Washington

City of Hudson  
Towns of Hudson, St. Joseph, Troy  
Village of North Hudson

Cities of Marinette, Kohler, Sheboygan, Sheboygan Falls, Sturgeon Bay  
Towns of Peshtigo, Porterfield, Mosel, Wilson, Lima, Herman, Sheboygan, Sheboygan Falls

**AGENCY (continued)**

Rock County Planning Agency  
51 South Main Street  
Janesville, WI 53545  
(608) 757-5587

Office of City Engineer  
400 LaCrosse Street  
LaCrosse, WI 54601  
(608) 789-7505

Portage County Planning Department  
1516 Church Street  
Stevens Point, WI 54481  
(715) 346-1334

Marathon County Planning Department  
210 River Drive  
Wausau, WI 54403  
(715) 847-5227

Wood County Planning  
400 Market Street  
Wisconsin Rapids, WI 54495  
(715) 421-8466

Dunn County Land Conservation  
390 Red Cedar Street  
Menomonie, WI 54751  
(715) 232-1520

**AREAS SERVED**

Cities of Janesville, Beloit, Edgerton, Evansville, Milton  
Towns of Beloit, Harmony, Rock, Janesville, LaPrairie, Turtle

Cities of LaCrosse, Onalaska  
Towns of Onalaska, Shelby, Medary, Campbell

City of Stevens Point  
Towns of Hull, Plover, Linwood  
Villages of Whiting, Plover, Park Ridge

Cities of Wausau, Schofield  
Towns of Weston, Stettin, Rib Mountain, Kronenwetter  
Village of Rothschild

City of Wisconsin Rapids  
Towns of Grand Rapids, Rudolph, Sigel, Seneca, Grant  
Village of Biron

City of Menomonie

**A-82.30 (4) SIZE OF DRAIN PIPING.** The following tables list the maximum GPM which can be expected to readily flow through a given size trap where the receptor has a height as indicated.

Also listed is a maximum drainage fixture unit load which a given size receptor trap may be expected to adequately receive.

**Note:** The department recommends an individual 4-inch diameter minimum trap and drain pipe for a commercial type dishwasher.

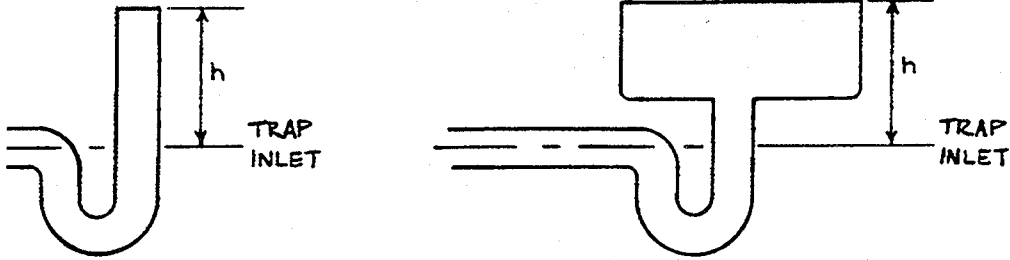

Receptor Trap Size	H - Height	GPM	d.f.u.
1-1/2"	12"	4	2
2"	14"	8	4
3"	15"	12	6
4"	17"	40	20
5"	20"	70	35
6"	22"	120	60
8"	25"	250	125

A-82.30 (6) (b) OFFSETS IN VERTICAL DRAINS.

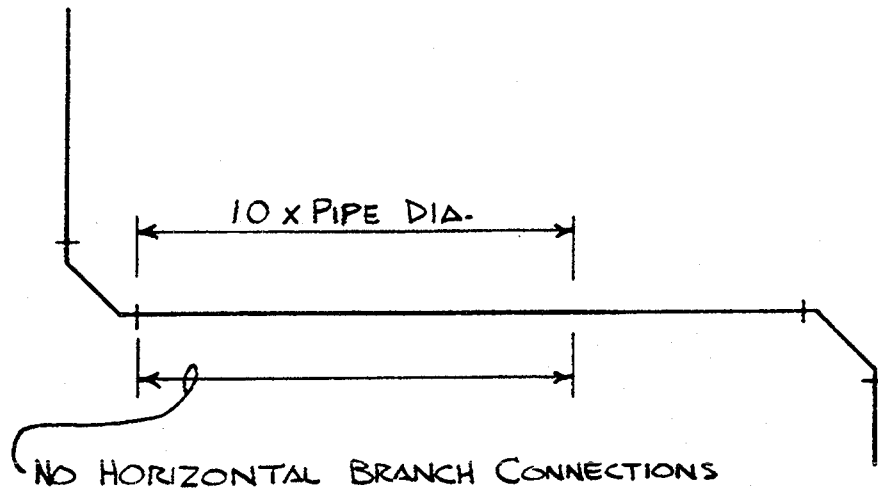
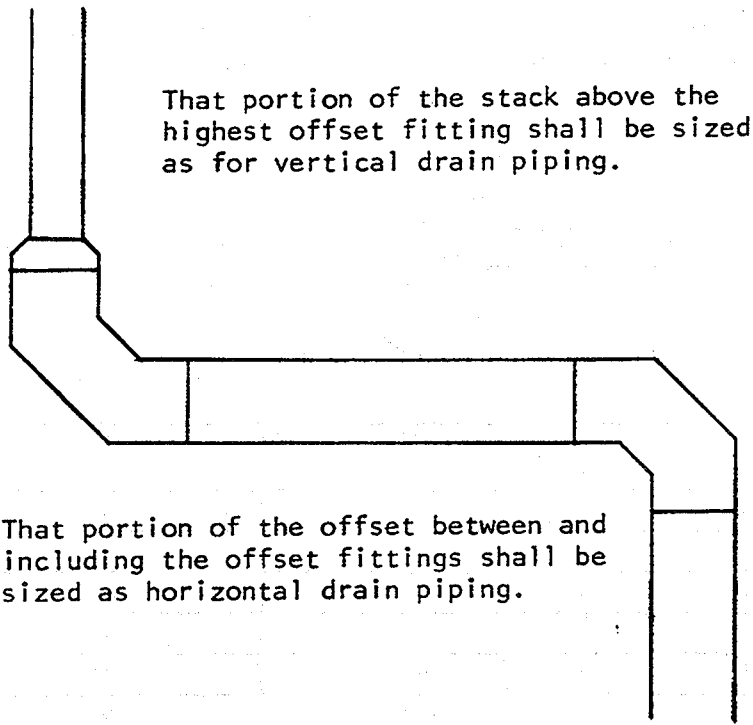

A-82.30 (7) HORIZONTAL BRANCH DRAIN CONNECTION AT BASE OF A STACK.

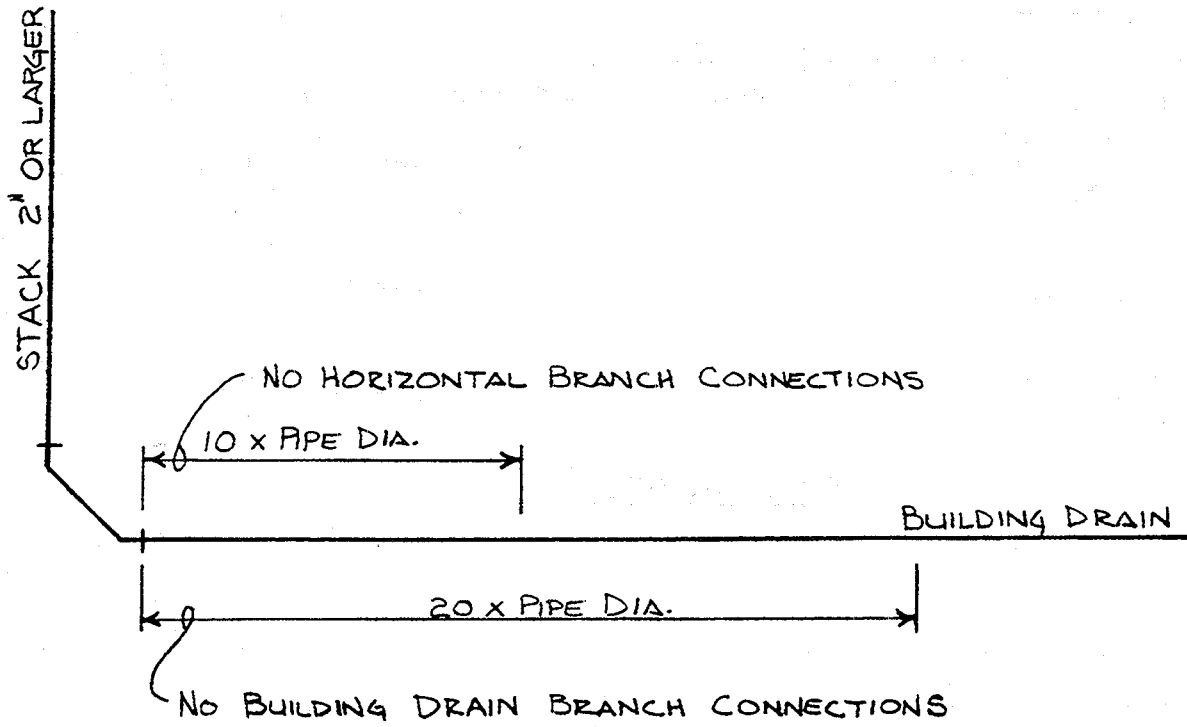

A-82.30 (8) MEASURING RADIUS OF A FITTING.

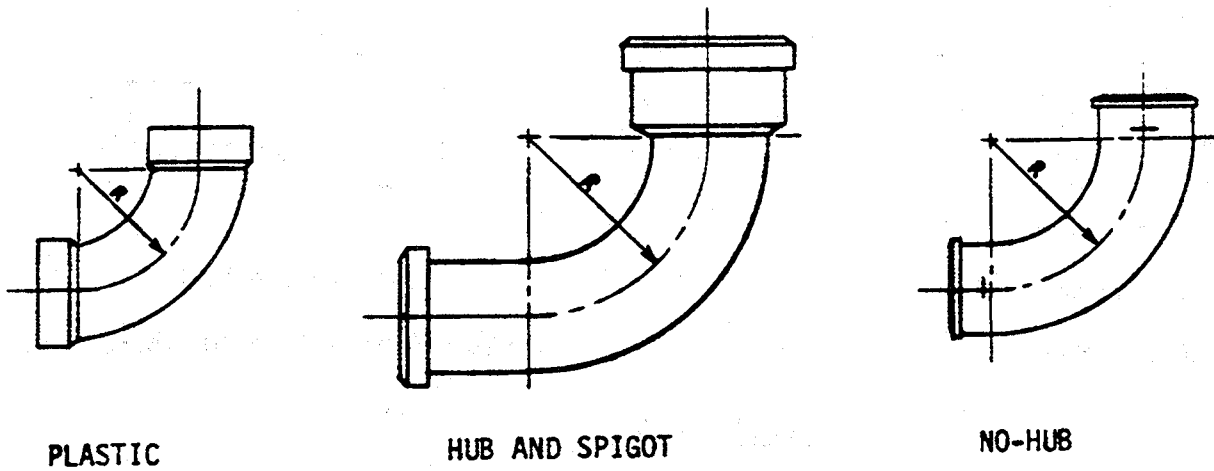

A-82.30 (9) DRAIN FITTINGS AND CONNECTIONS.

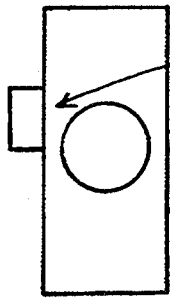

SIDE VIEW

SHALL NOT BE USED  
AS A VENT CONNECTION

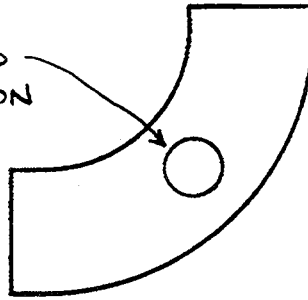

SIDE VIEW

SIDE INLETS

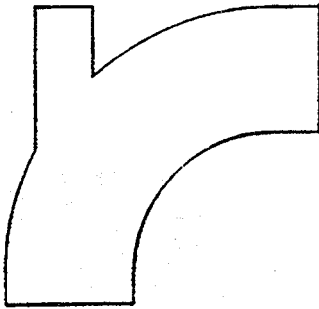

ALLOWED  
(SIDE VIEW)

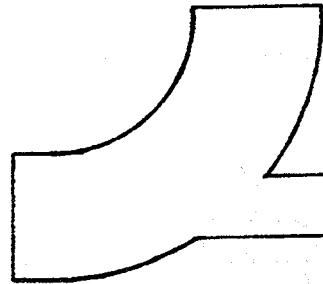

NOT ALLOWED  
(TOP VIEW OR SIDE VIEW)

HEEL INLETS



A-82.30 (10) (a) DETERMINING REQUIRED CAPACITY OF SANITARY PUMP.

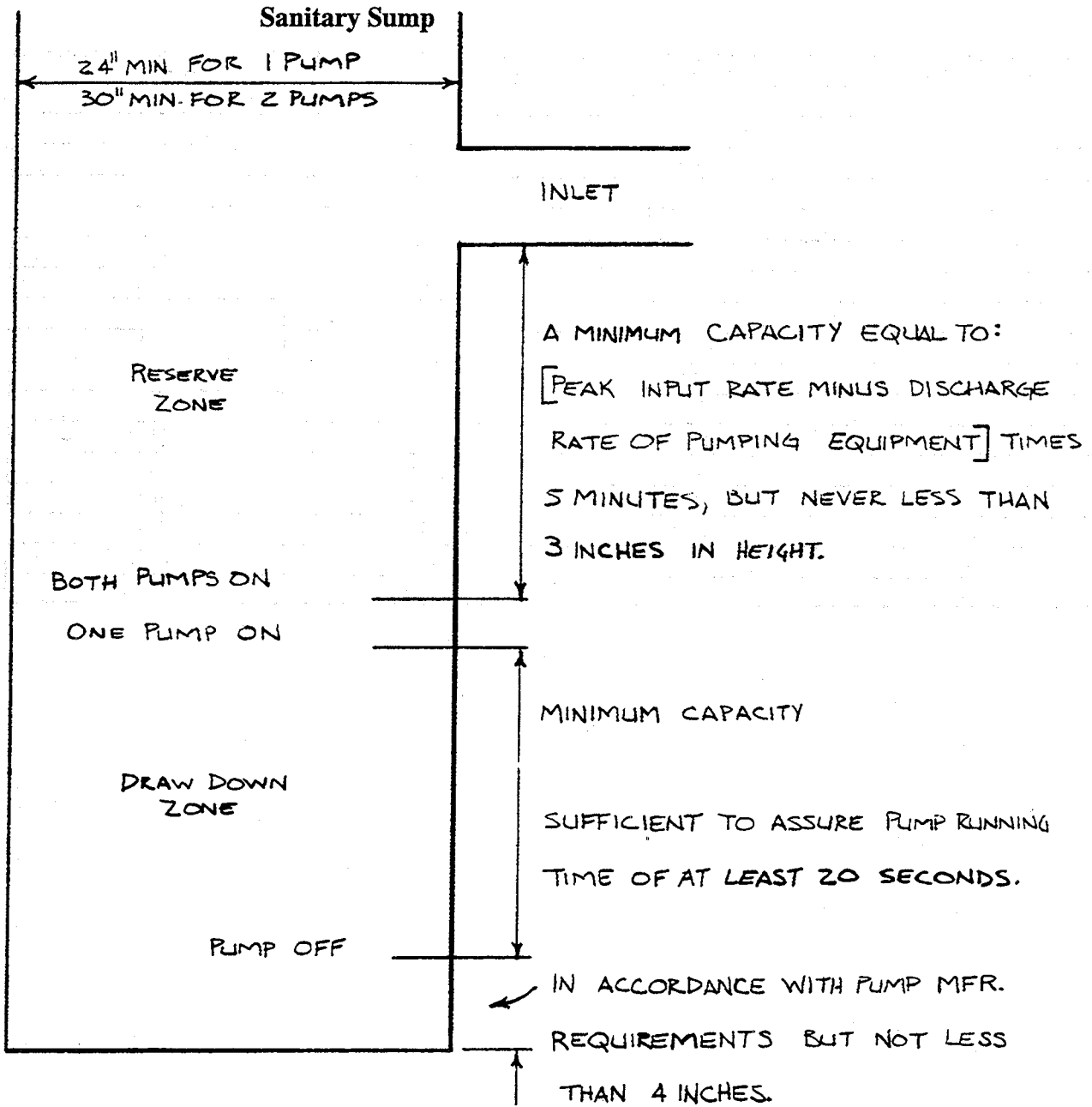

## A-82.30 (10) (a) SUMPS.

Capacity of sumps  
(in gallons)

Diameter of sump in inches	Volume in gal/ft	Diameter of sump in inches	Volume in gal/ft
24	23.5	41	68.6
25	25.5	42	72.1
26	27.6	43	75.5
27	29.7	44	79.1
28	32.0	45	82.7
29	34.3	46	86.5
30	36.8	47	90.2
31	39.2	48	94.0
32	41.8	54	119.0
33	44.5	60	147.0
34	47.2	66	178.0
35	50.0	72	211.5
36	52.8	78	248.4
37	55.9	84	288.1
38	59.0	90	330.8
39	62.1	96	376.3
40	65.3	108	477.3

A-82.30 (11) (b) BUILDING DRAINS SERVING ANY BUILDING.

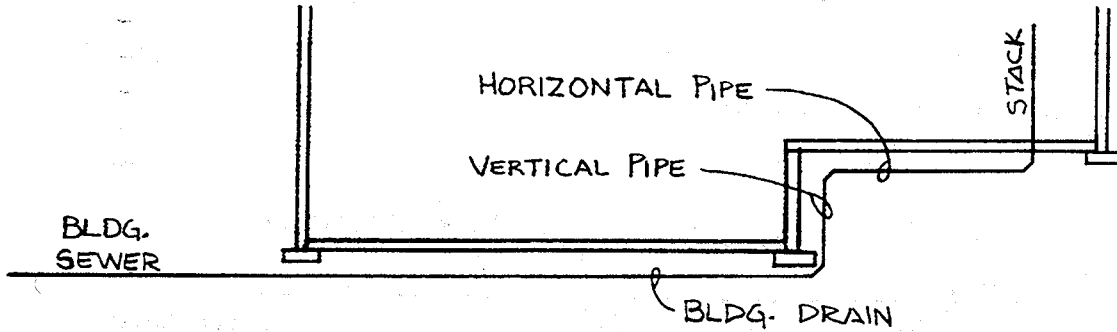
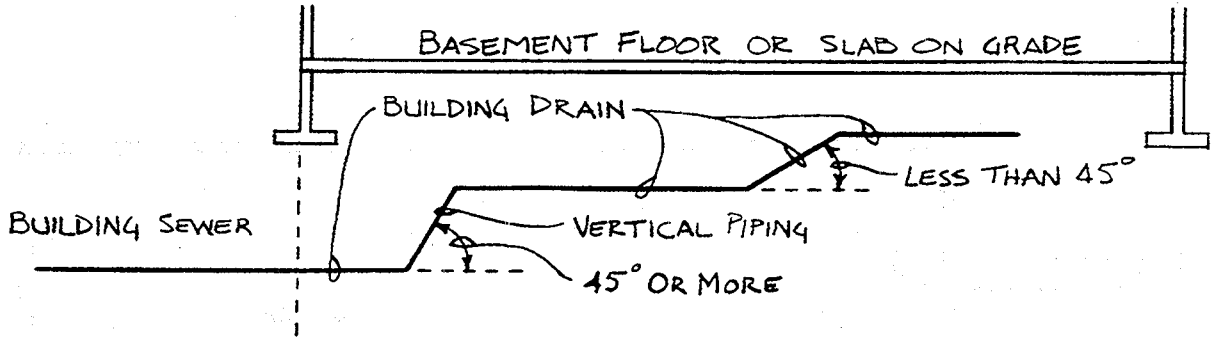

A-82.30 (11) (b) BUILDING DRAINS.

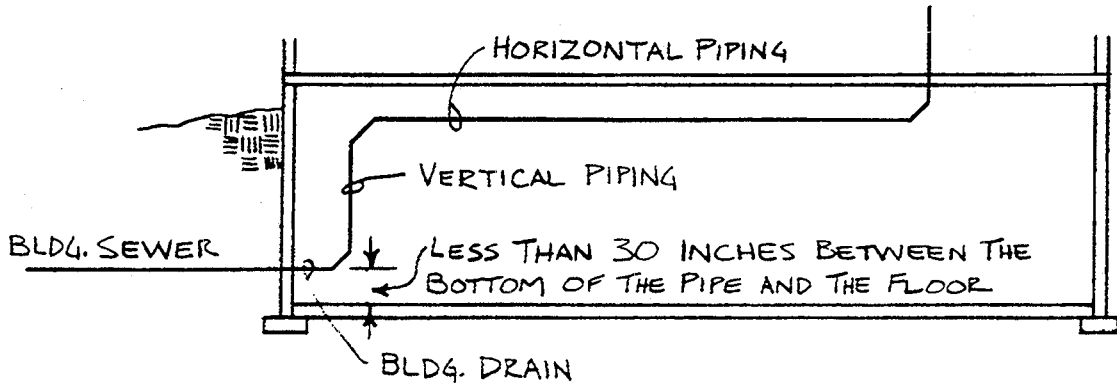
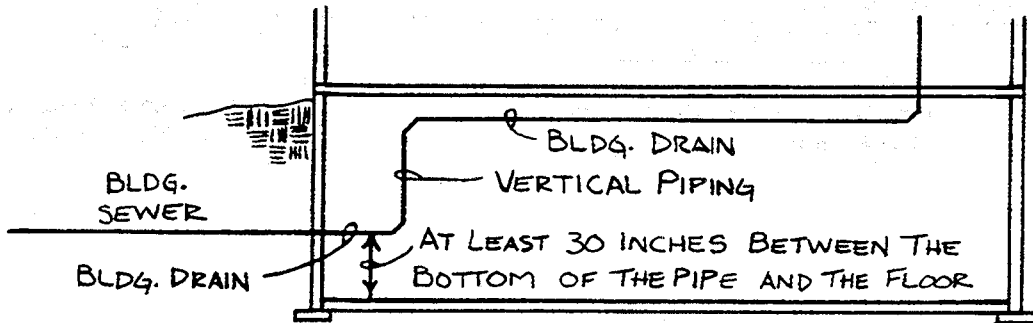

A-82.30 (11) (b) FLOOR DRAIN REQUIRED.

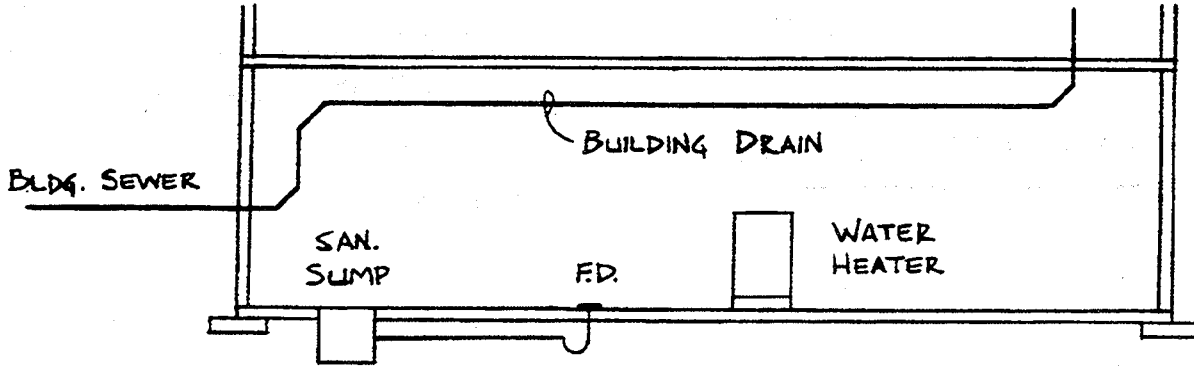

A-82.30 (11) (f) CONNECTION TO PRESSURIZED PUBLIC SEWER

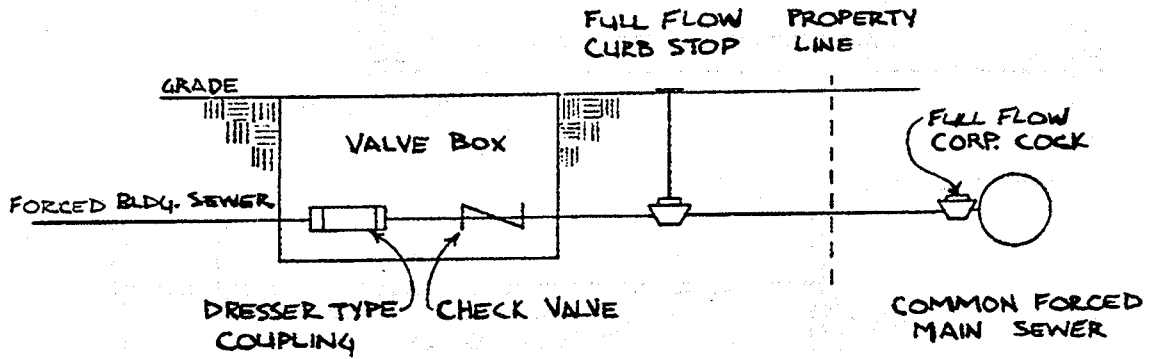

A-82.31 (4) (a) WHERE A VENT STACK AND STACK VENT ARE REQUIRED.

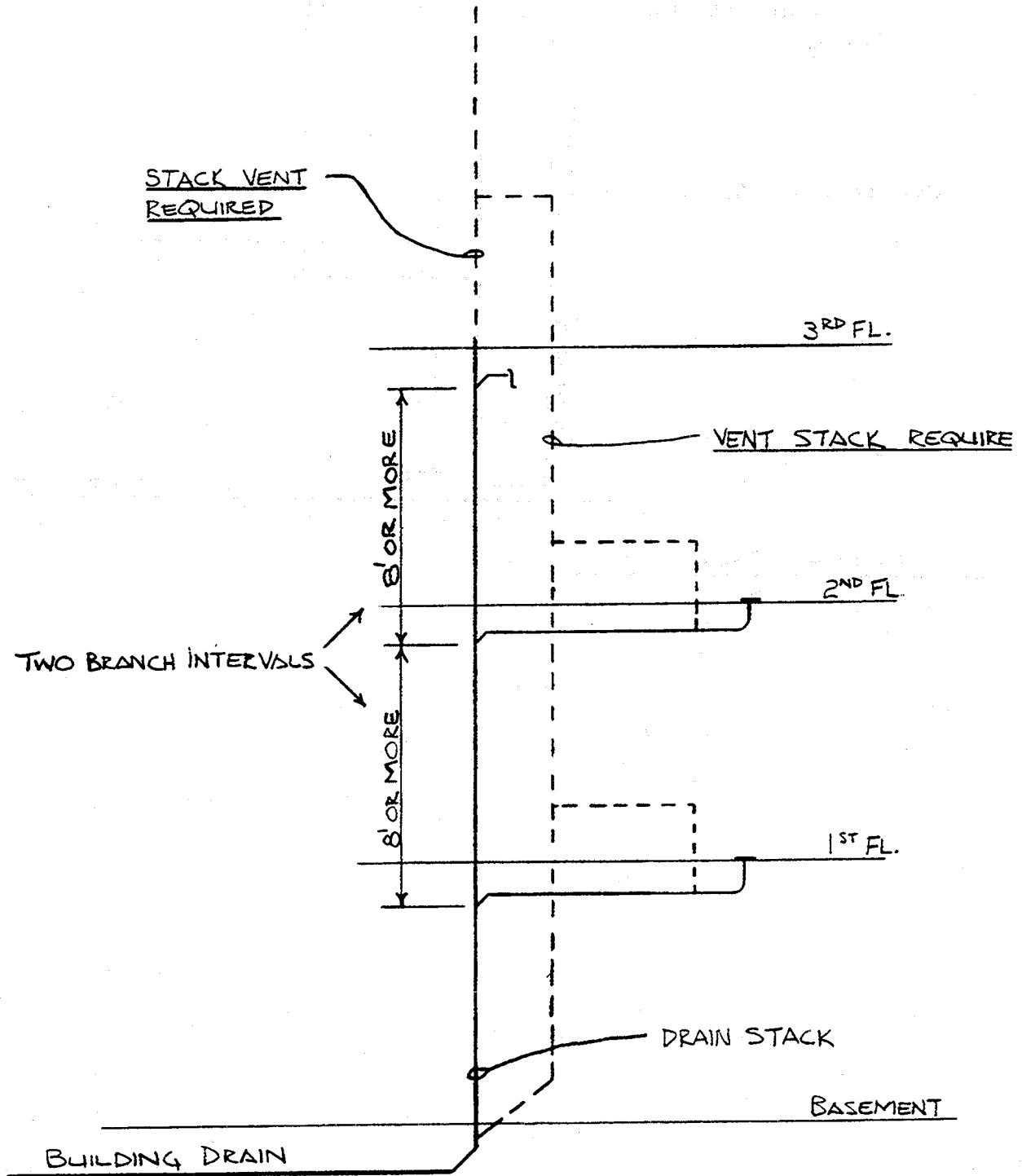

A-82.31 (4) (a) WHERE A VENT STACK AND STACK VENT ARE NOT REQUIRED.

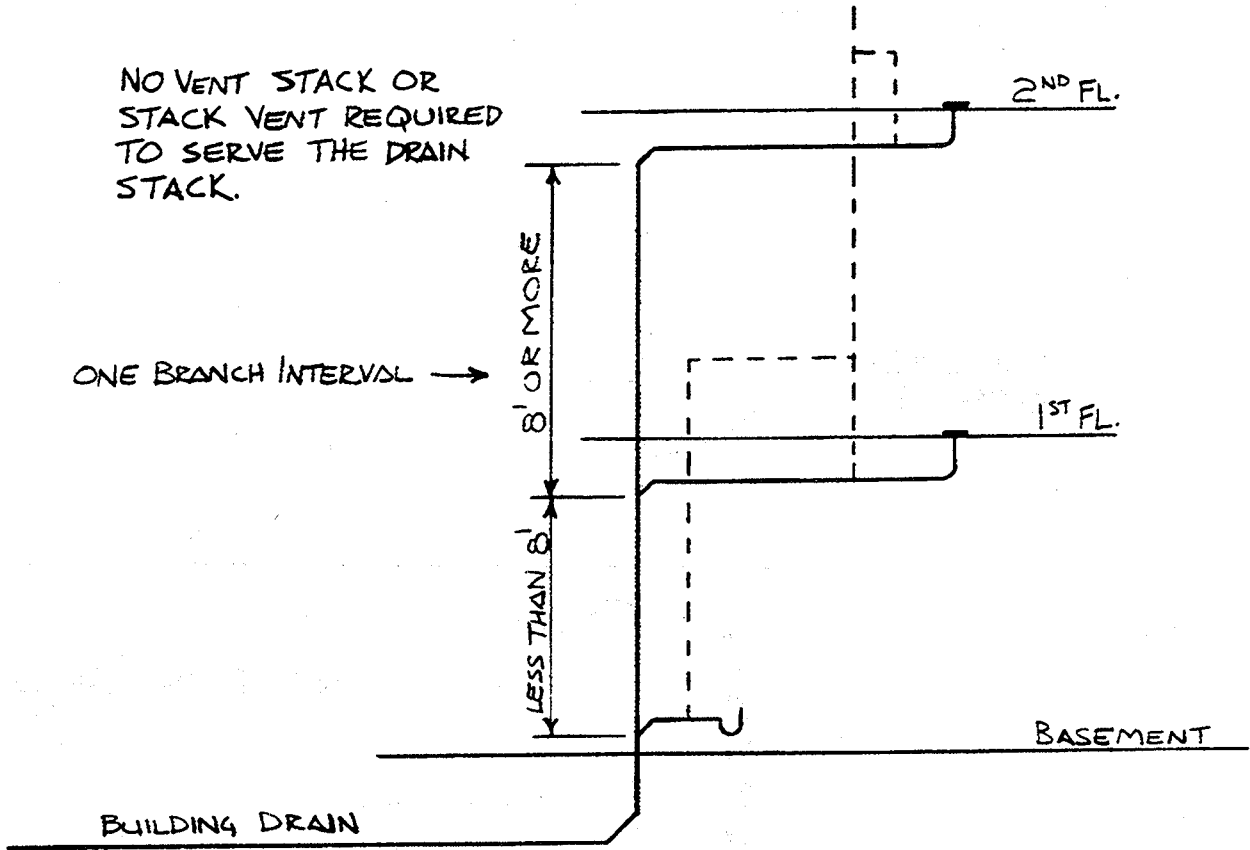

A-82.31 (4) (b) INSTALLATION OF VENT STACK AND STACK VENT

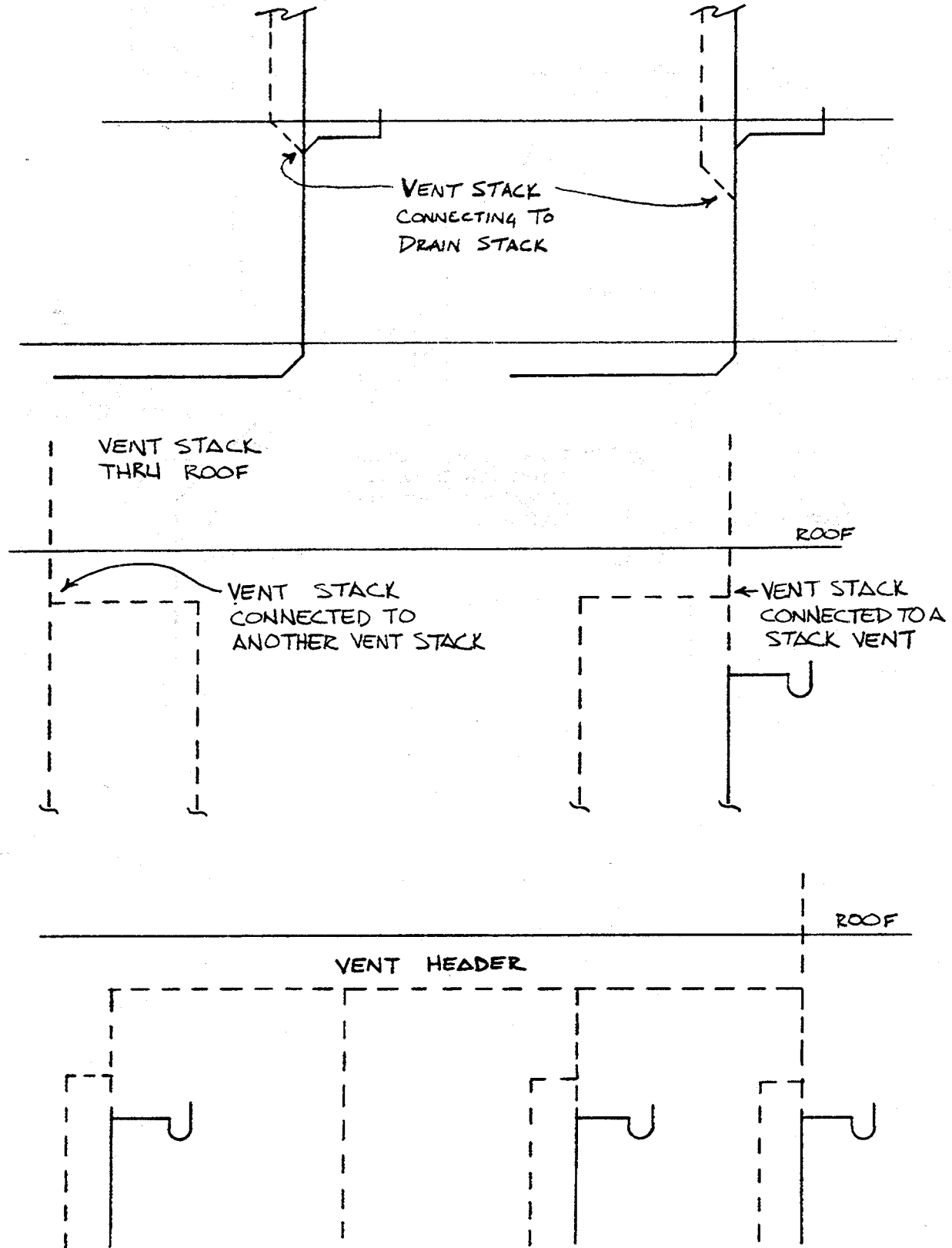

A-82.31 (5) (a) Relief vent for offsets of 30 to 45 degrees.

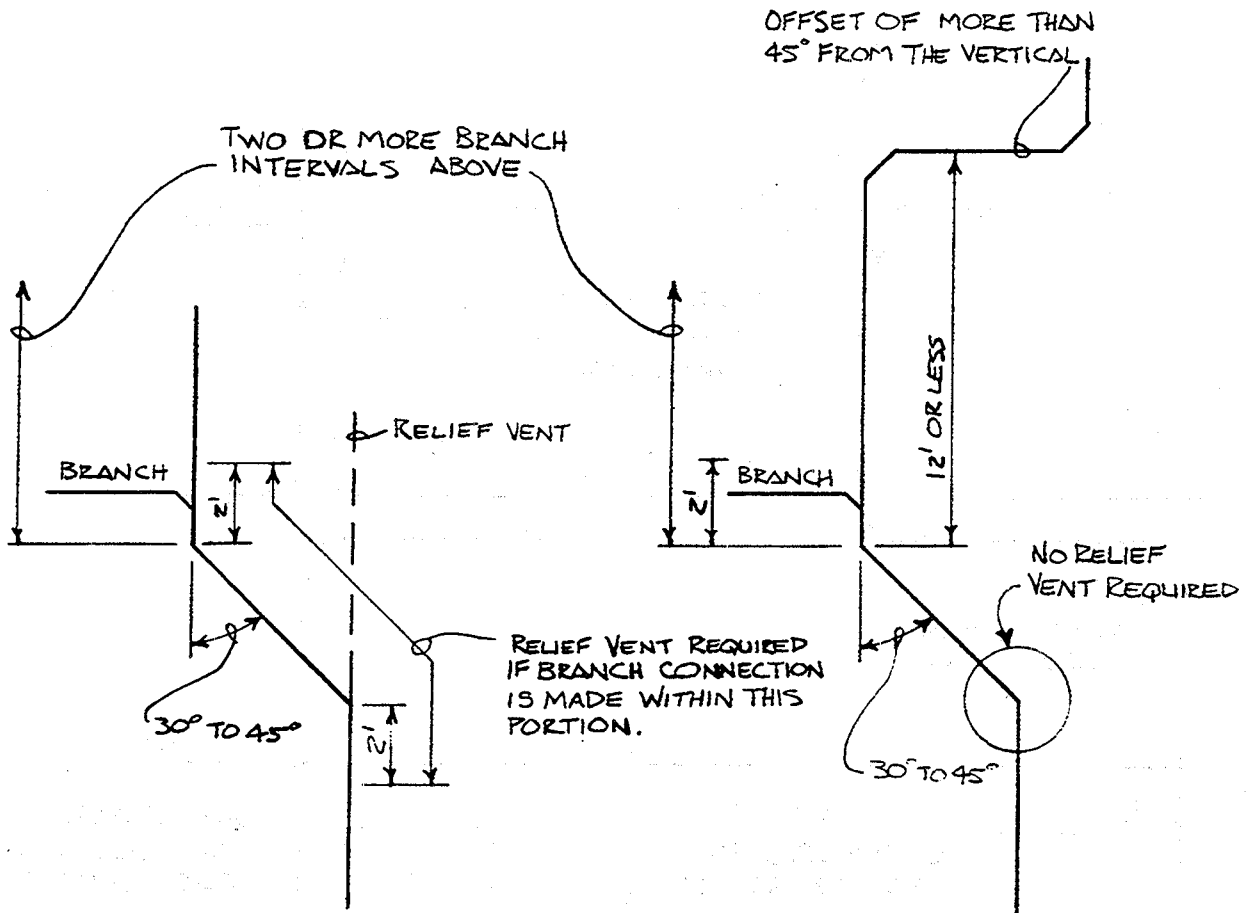



A-82.31 (5) (b) RELIEF AND YOKE VENTS FOR OFFSETS OF MORE THAN 45 DEGREES.

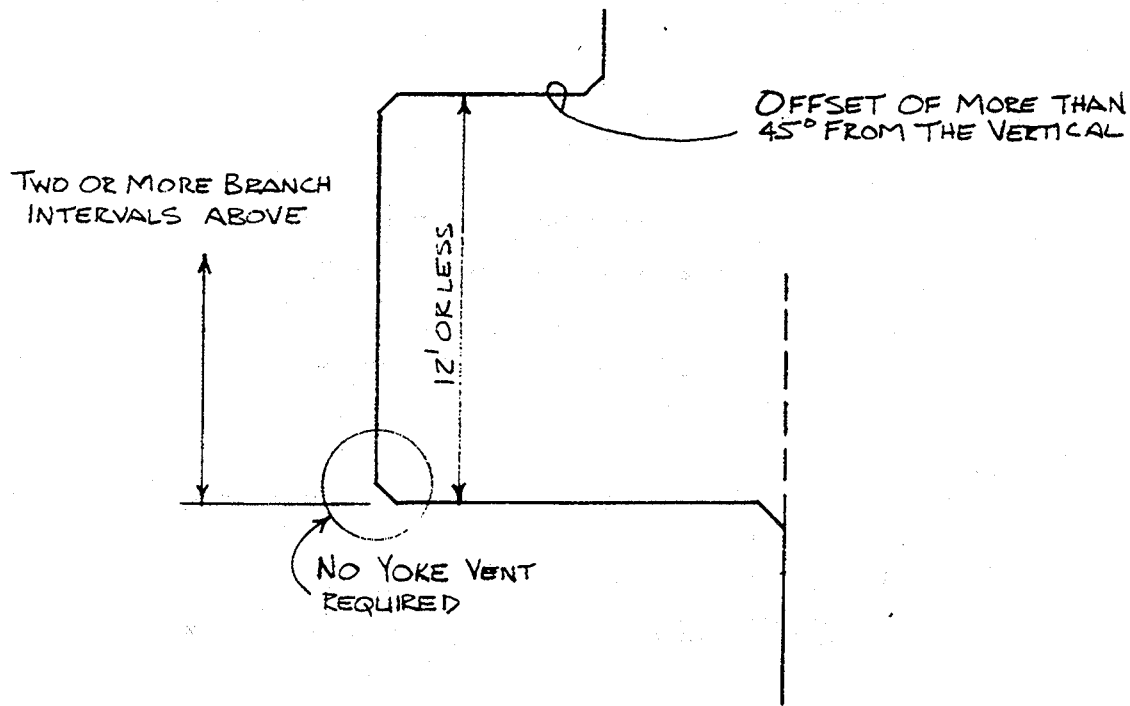
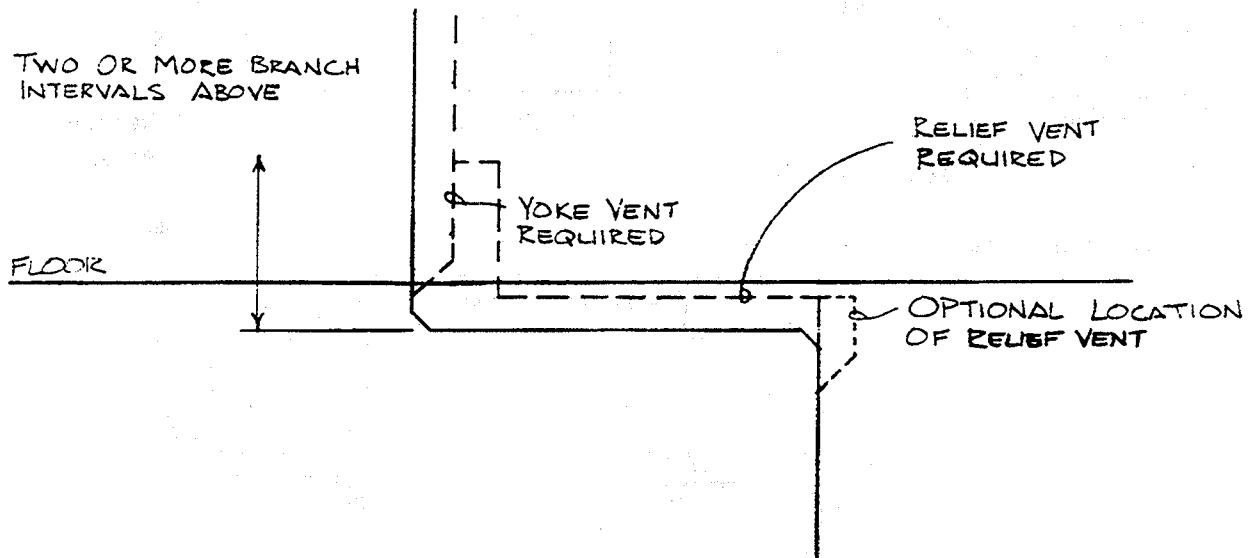

A-82.31 (7) RELIEF VENTS FOR BUILDING DRAINS.

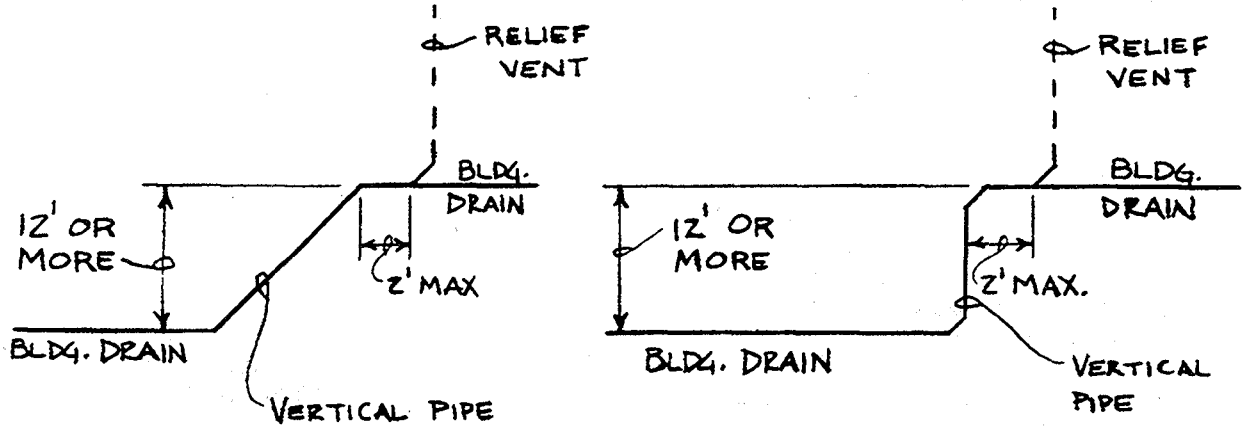

A-82.31 (9) FIXTURE VENTS.

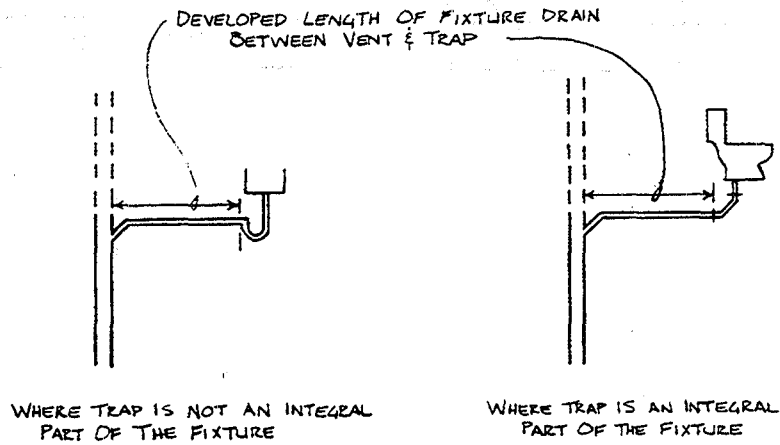

VENT CONNECTING TO HORIZONTAL DRAIN PIPING

VENT CONNECTING TO VERTICAL DRAIN PIPING

BY MEANS OF A SANITARY TEE FITTING

BY MEANS OF A WYE PATTERN FITTING

A-82.31 (10) CIRCUIT VENTING

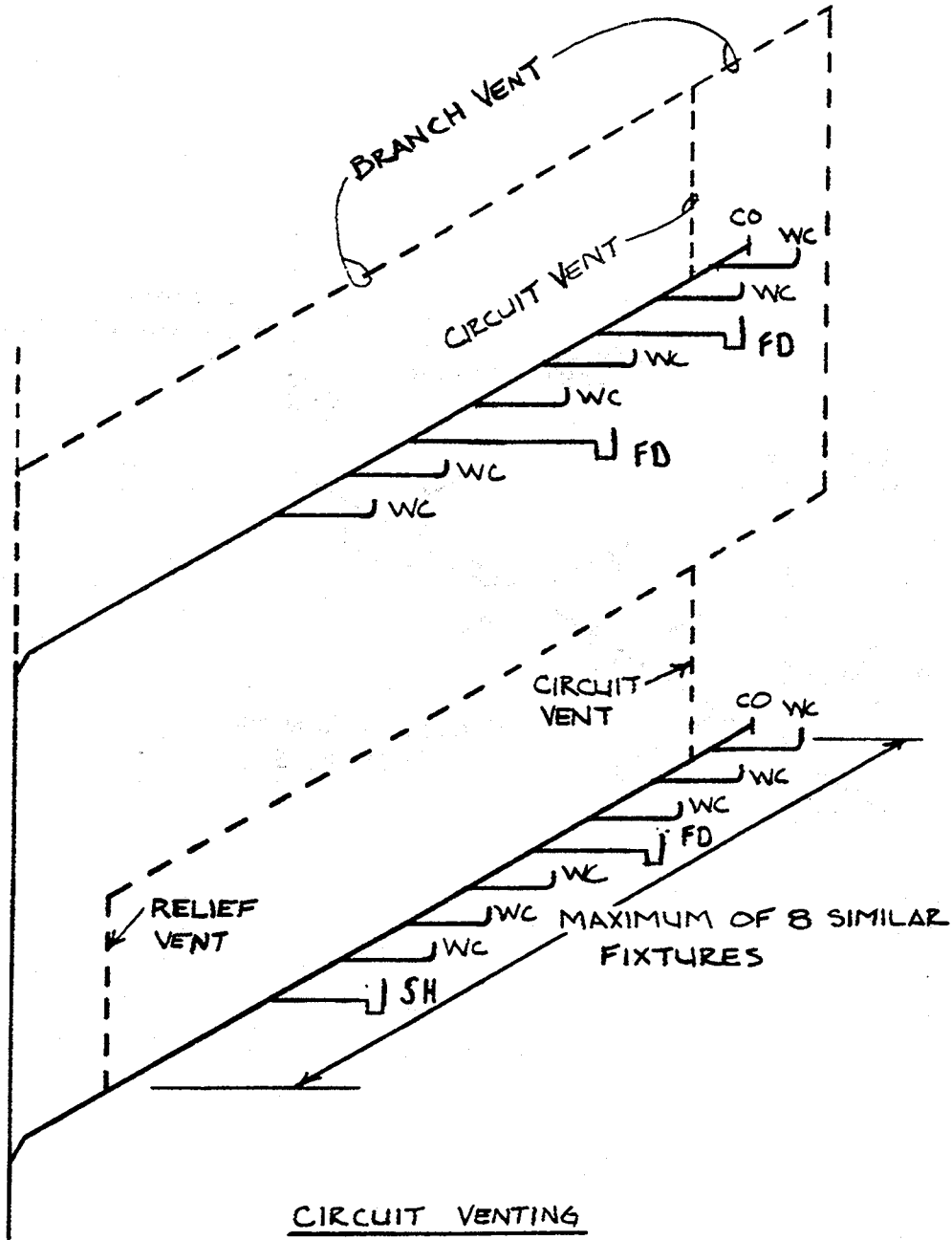

A-82.31 (10) CIRCUIT VENTING

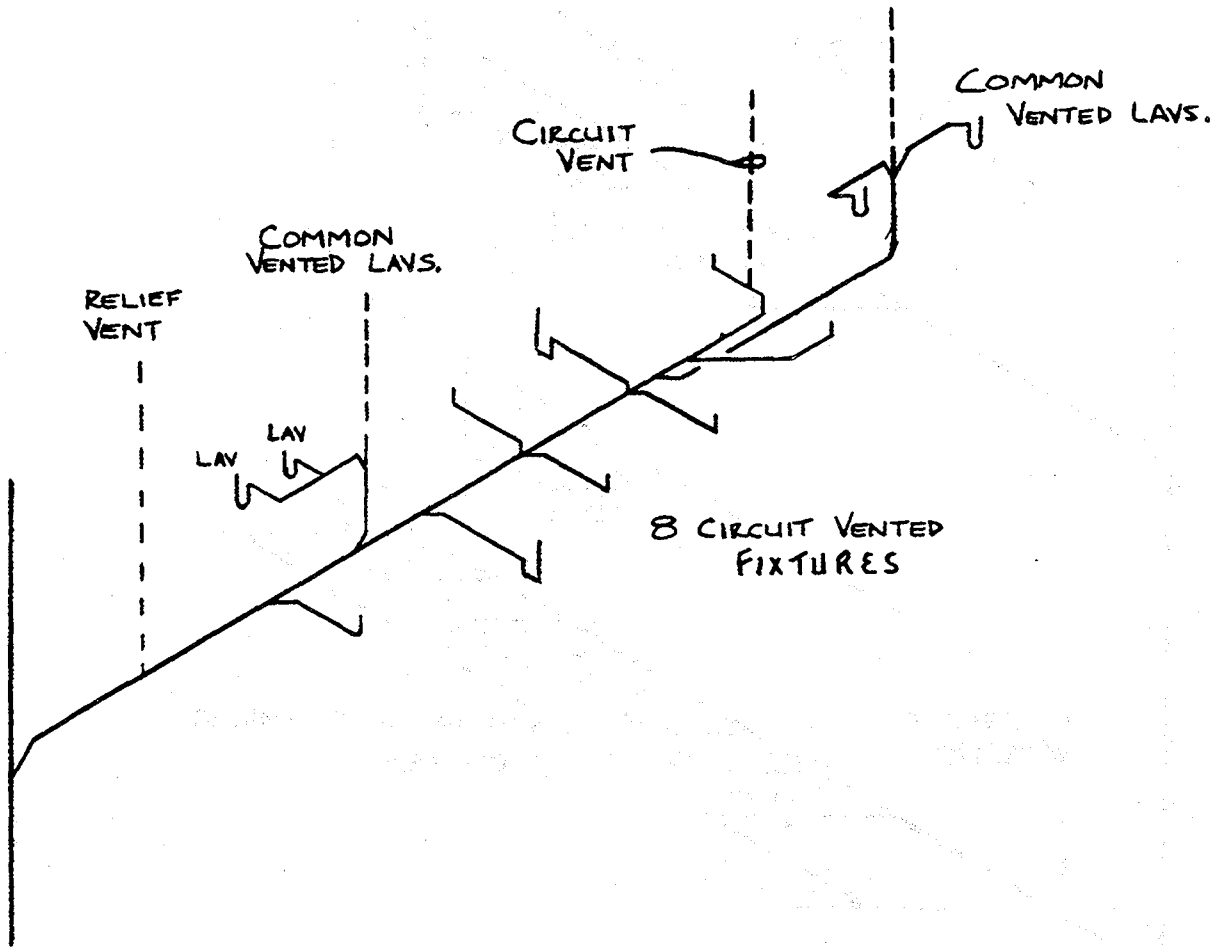

A-82.31 (10) CIRCUIT VENTING

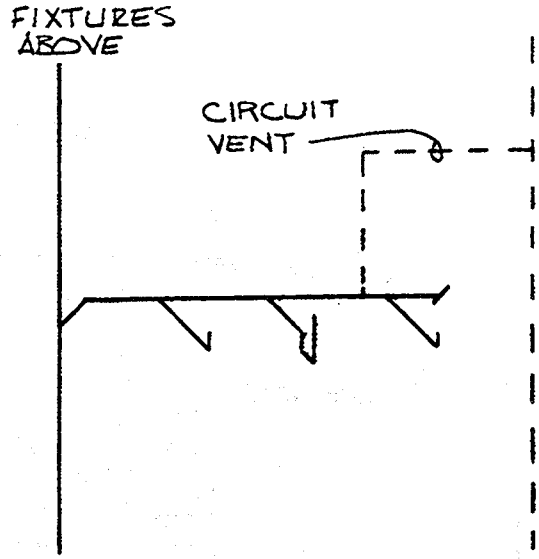
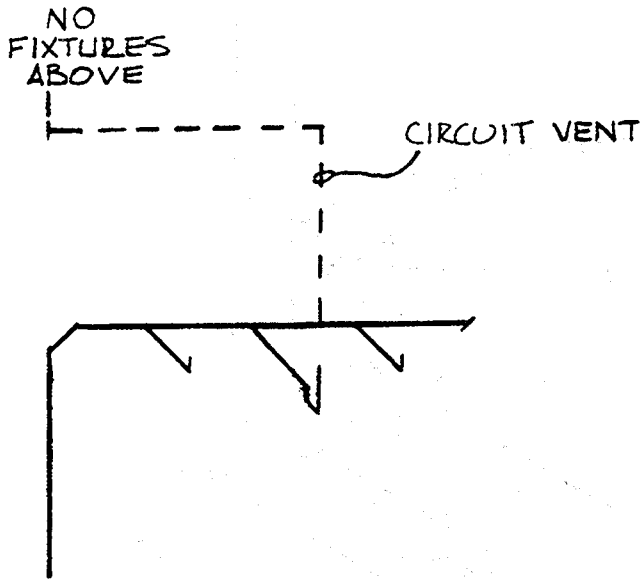

CIRCUIT VENTING  
3 FIXTURES

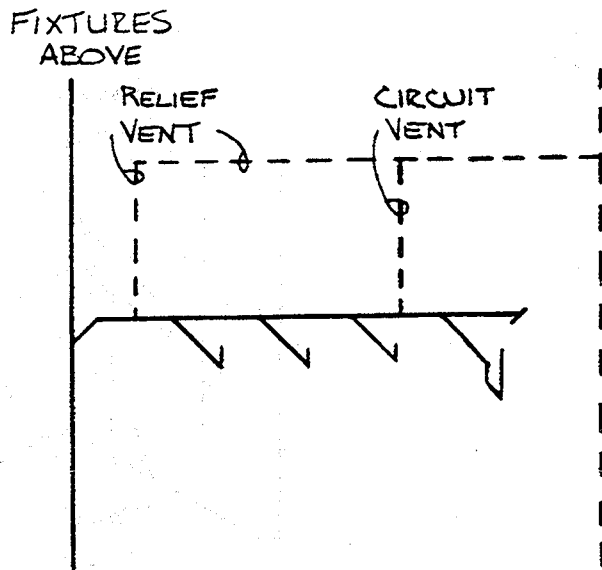
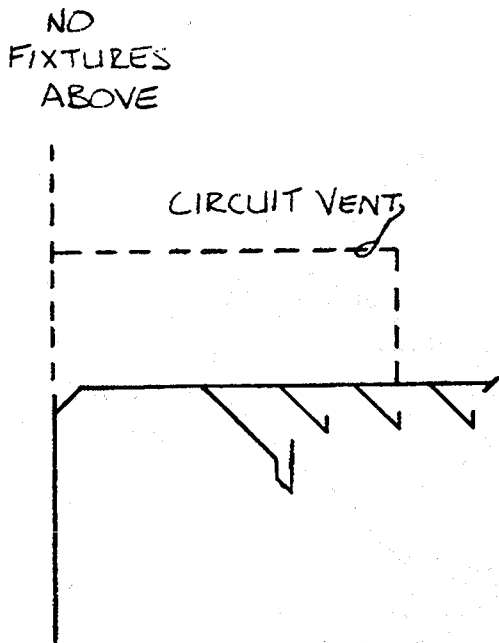

CIRCUIT VENTING 4 OR  
MORE FIXTURES

A-82.31 (10) CIRCUIT VENTING.

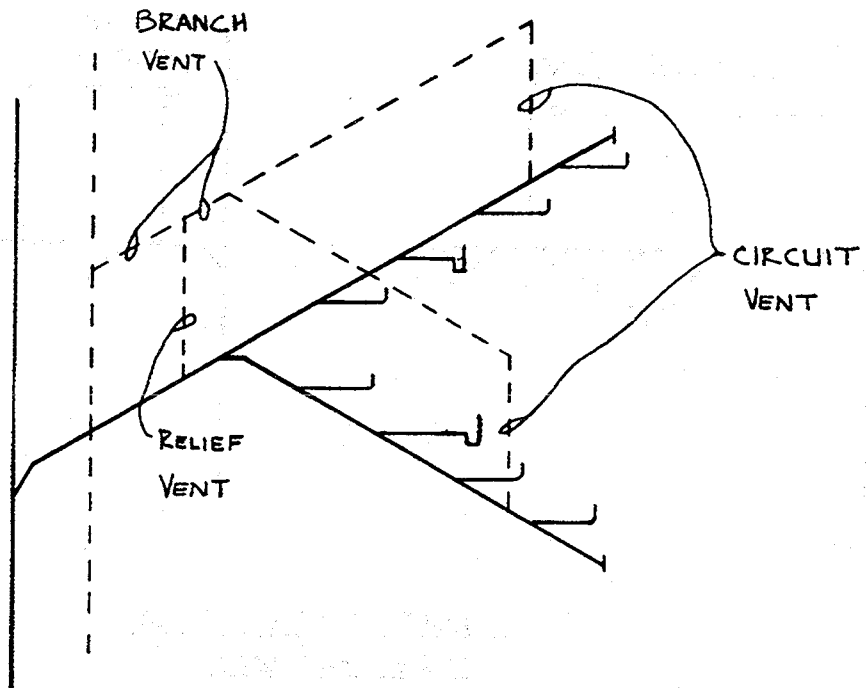
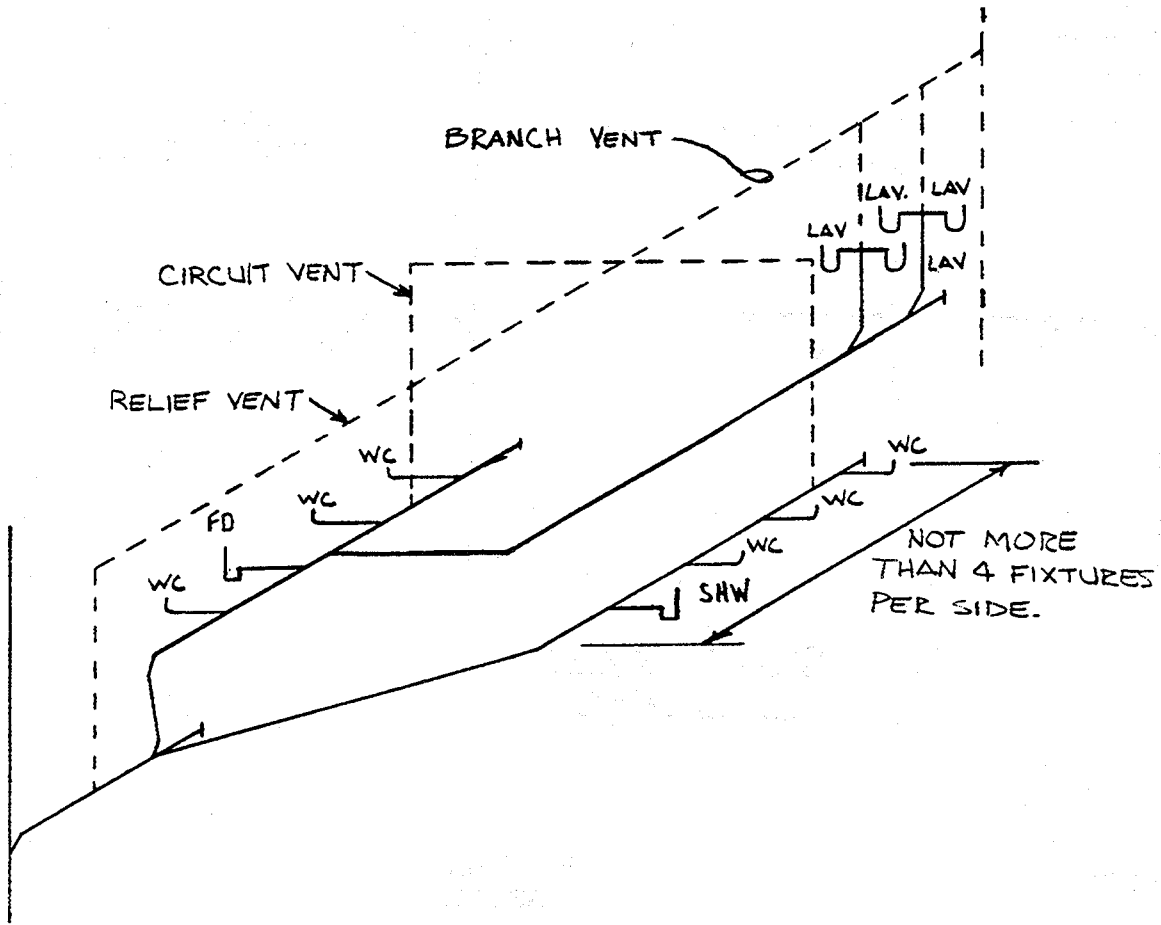

A-82.31 (11) (a) COMMON VENTS, VERTICAL DRAINS

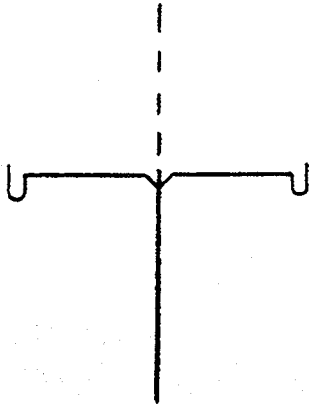

BACK-TO-BACK

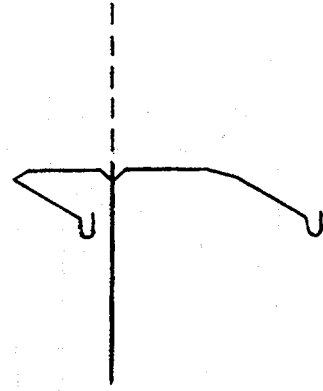

SIDE-BY-SIDE

COMMON VENT SERVING ANY TWO FIXTURES

A-82.31 (11) (b) COMMON VENTS, HORIZONTAL DRAINS

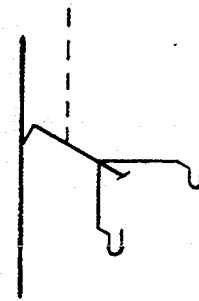
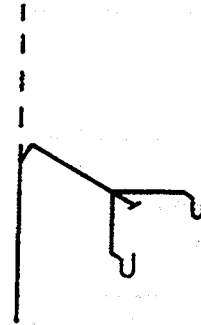
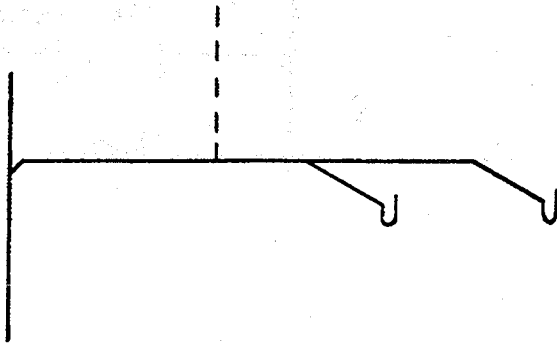
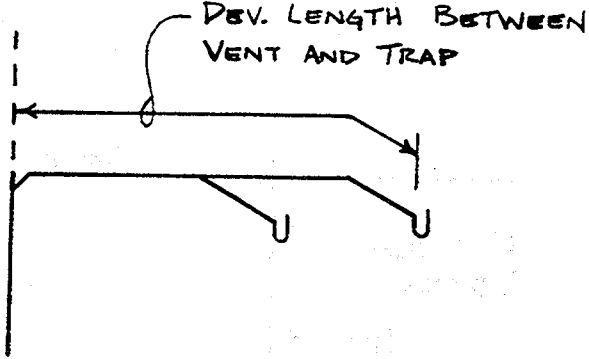

A-82.31 (12) ISLAND FIXTURE VENTING.

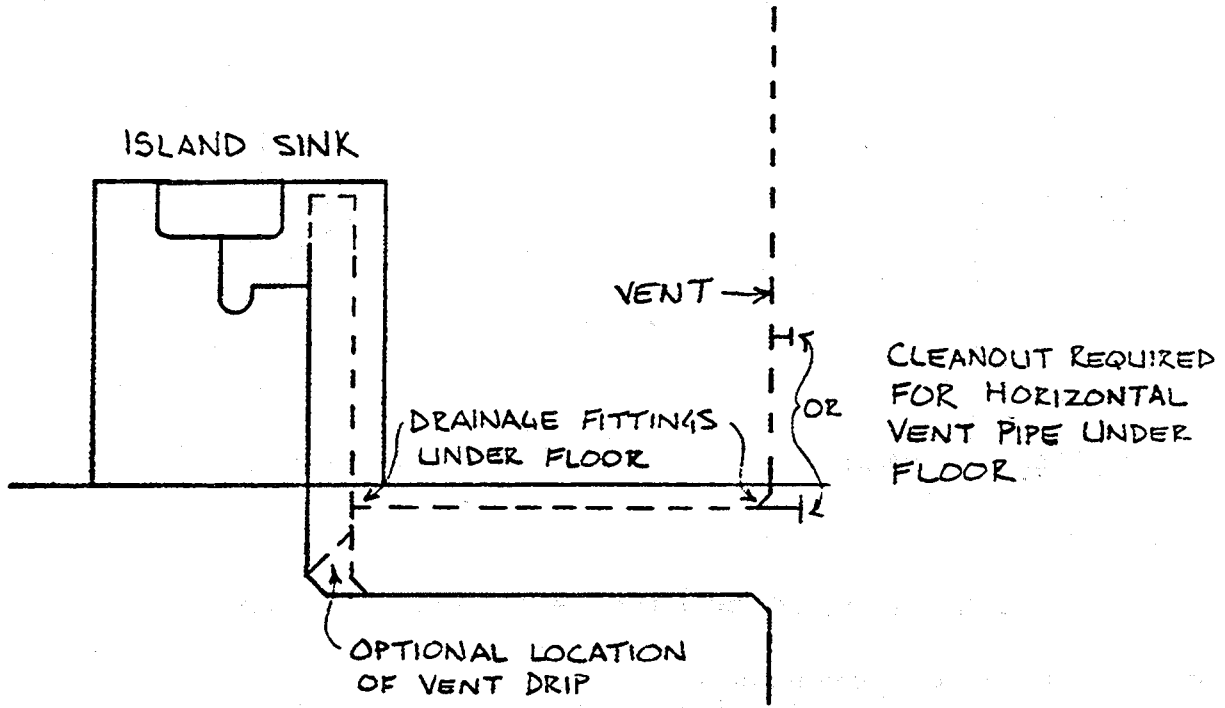

A-82.31 (13) (a) VERTICAL WET VENTS.

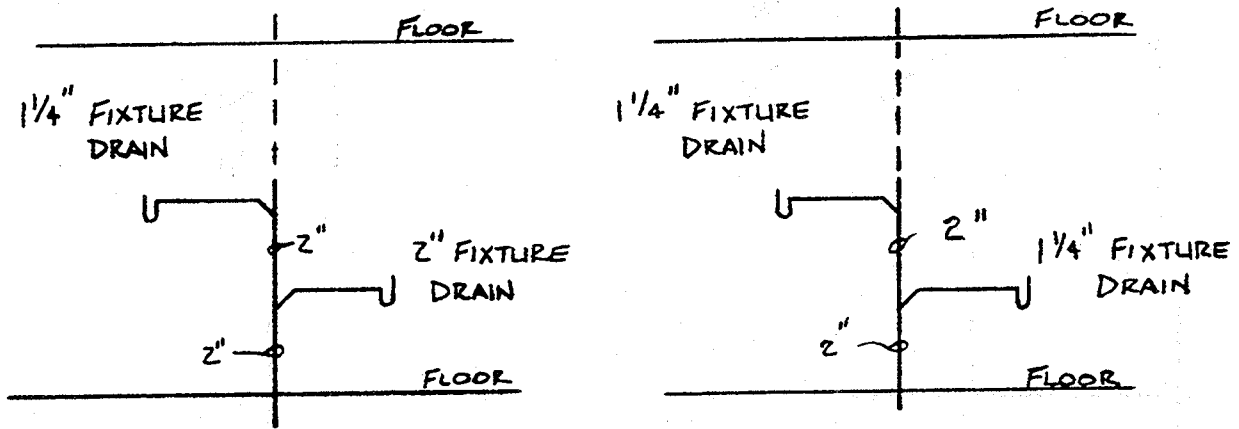



A-82.31 (13) (b) HORIZONTAL WEI VENTS.

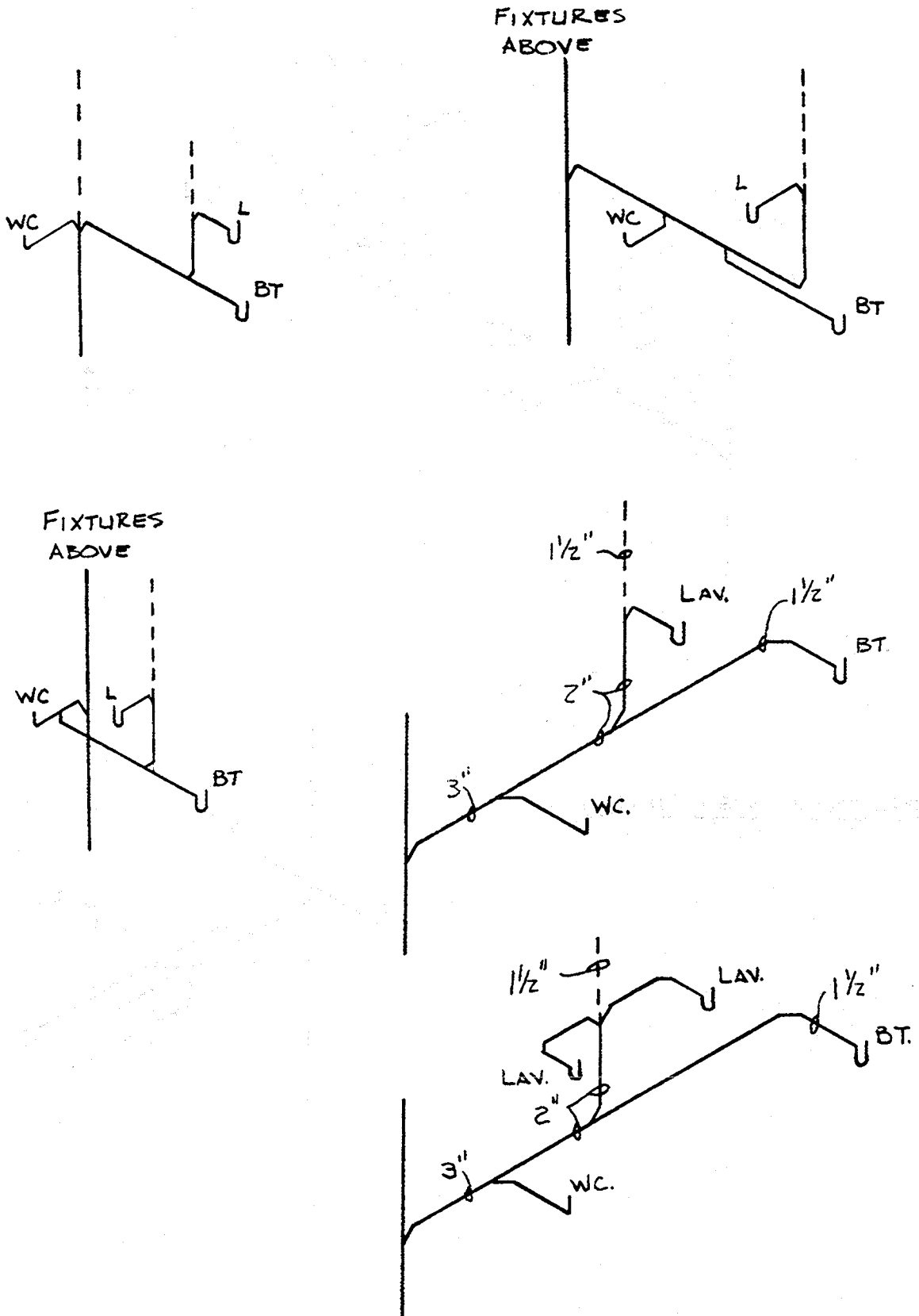

A-82.31 (13) (b) HORIZONTAL WET VENTS

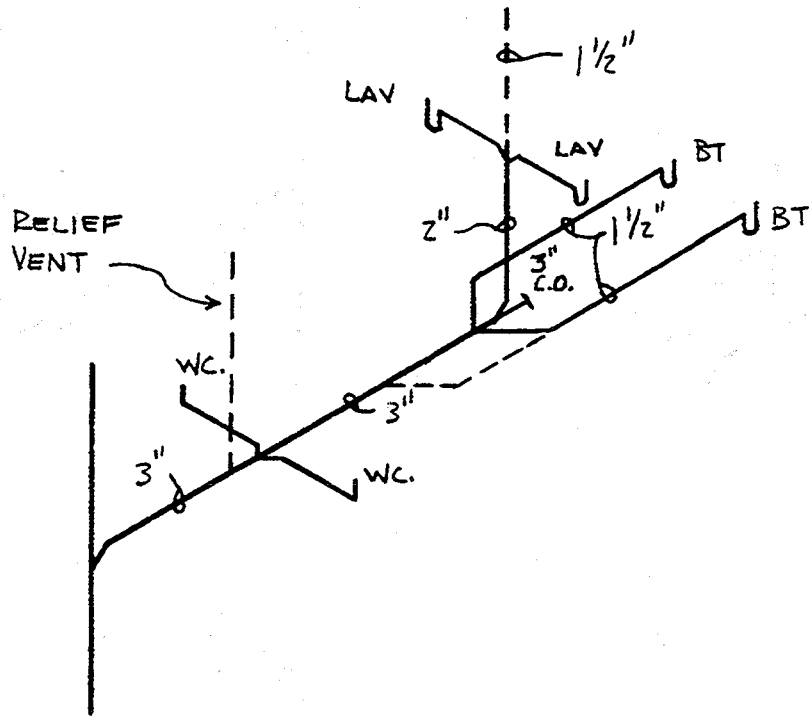

HORIZONTAL WET VENTS

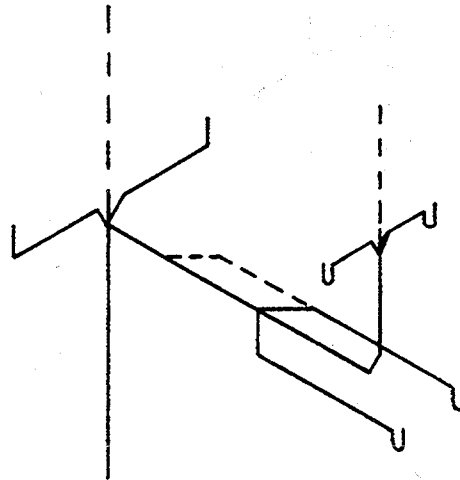

A-82.31 (13) (c) WET VENTING - FLOOR OUTLET FIXTURES

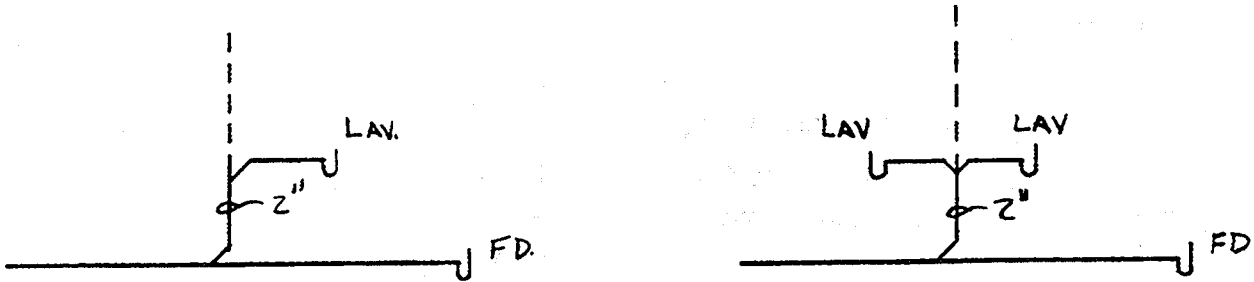

INDIVIDUAL VENT FOR FLOOR OUTLET FIXTURE  
SERVING AS A WET VENT

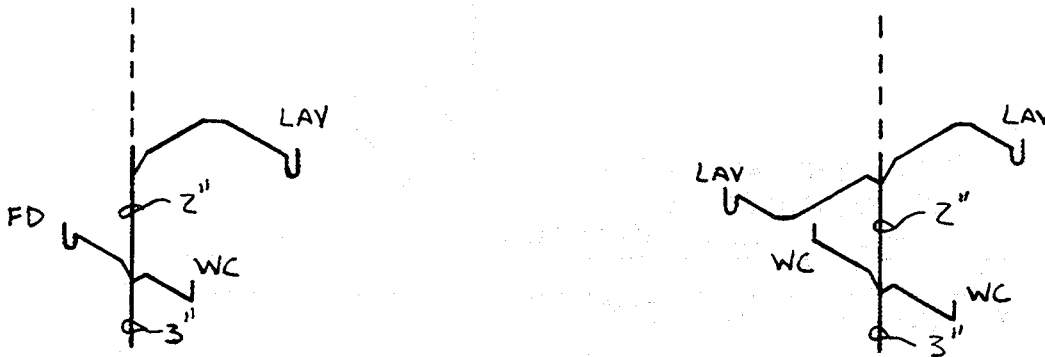

COMMON VENT FOR FLOOR OUTLET FIXTURES  
SERVING AS A WET VENT

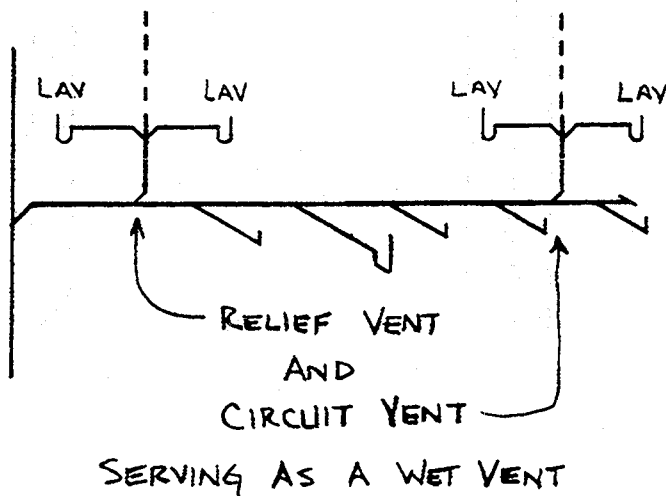

A-82.31 (14) (a) and (b) SIZING VENT STACKS AND STACK VENTS.

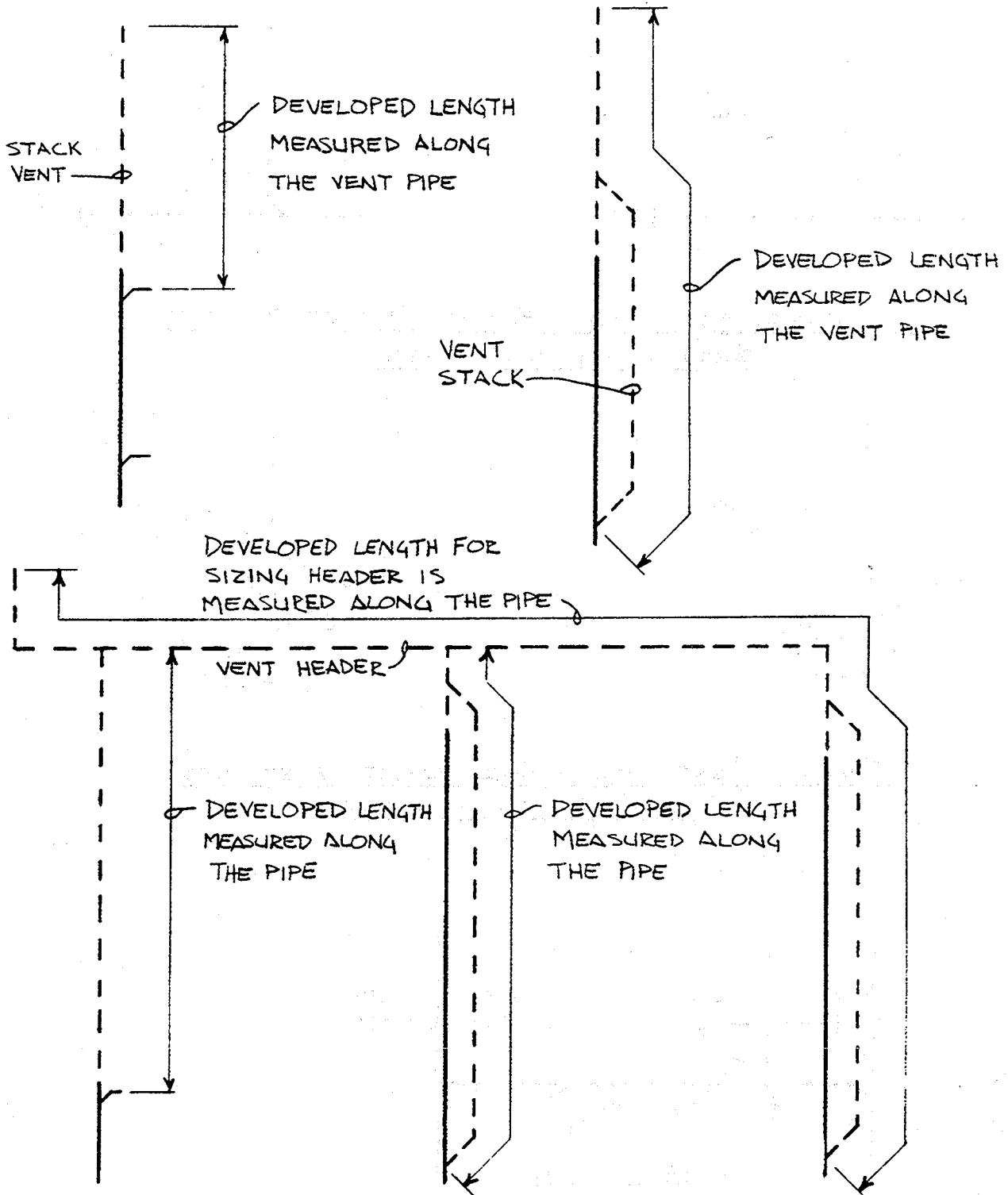

A-82.31 (14) (c) SIZING BRANCH VENTS

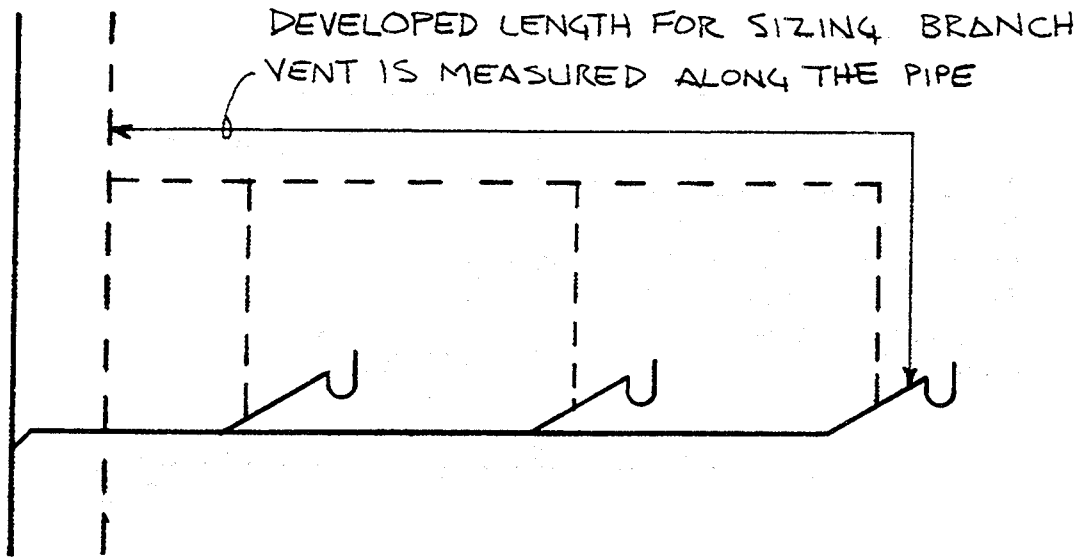

A-82.31 (14) (d) SIZING INDIVIDUAL VENTS

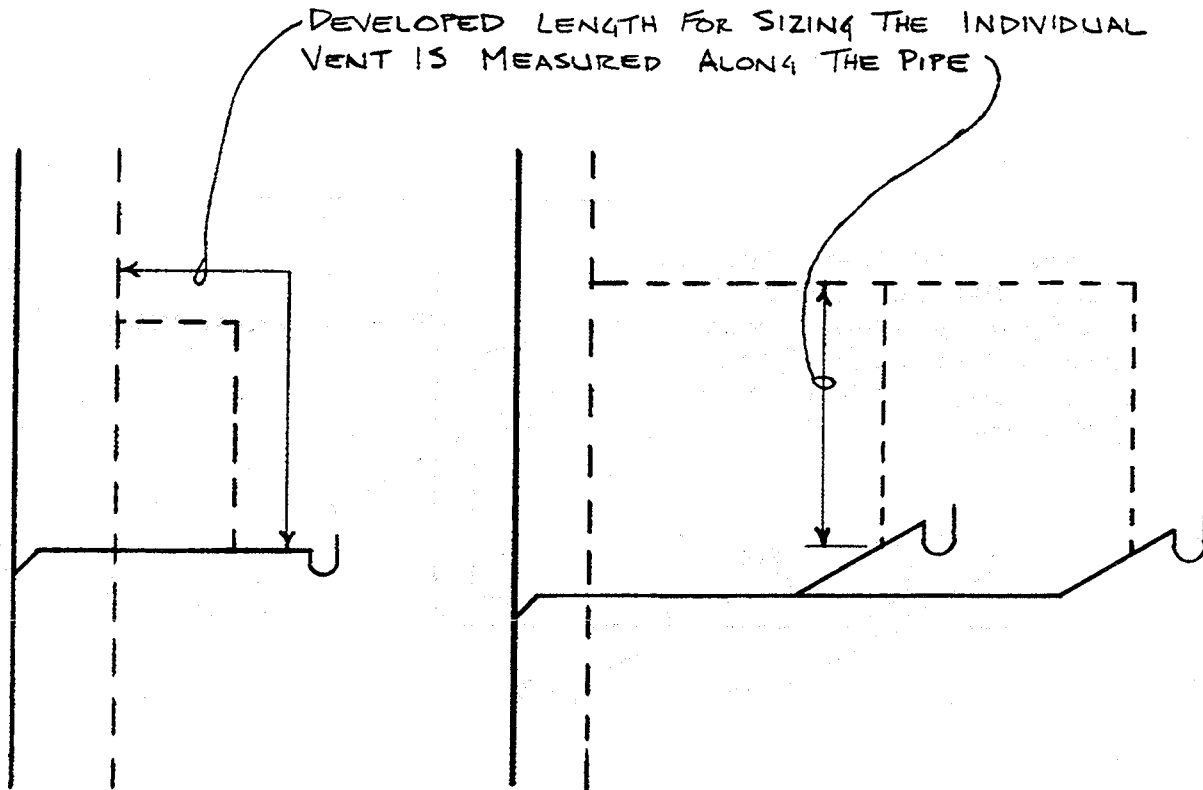

A-82.31 (14) (c) SIZING BRANCH VENTS SERVING A WET VENT.

WHEN SIZING THE BRANCH VENT, THE DEVELOPED LENGTH IS MEASURED ALONG THE VENT PIPE, INCLUDING THE WET VENT PORTION.

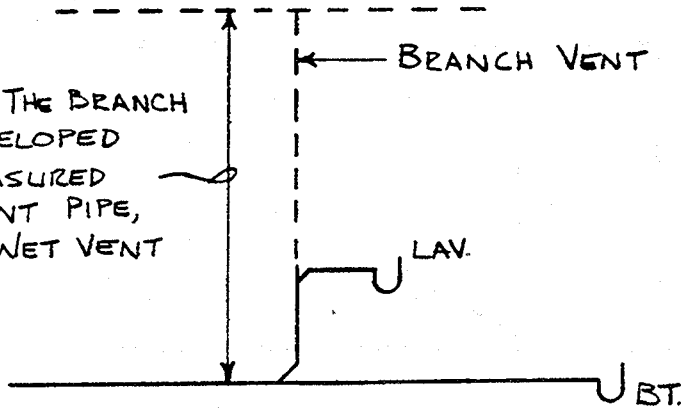

WHEN SIZING THE BRANCH VENT, THE DEVELOPED LENGTH IS MEASURED ALONG THE VENT PIPE, INCLUDING THE WET VENT PORTION.

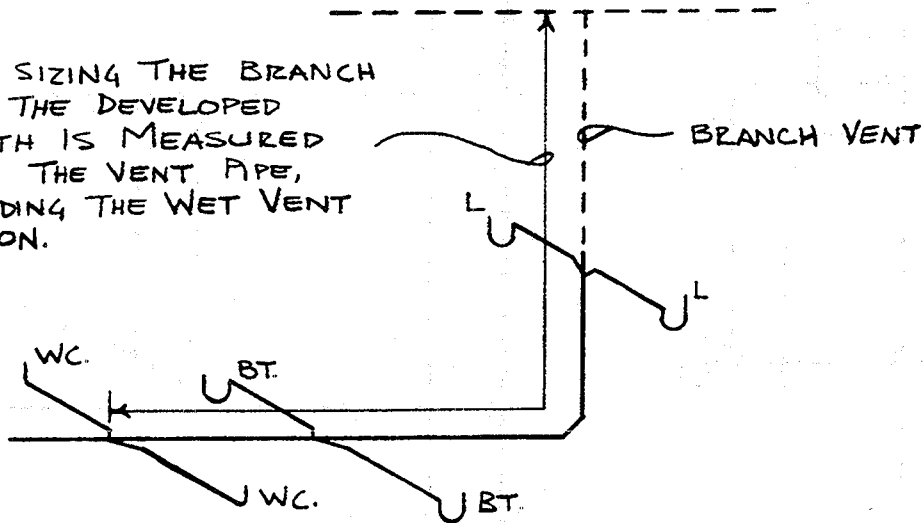

A-82.31 (15) (a) VENT GRADES AND CONNECTIONS.

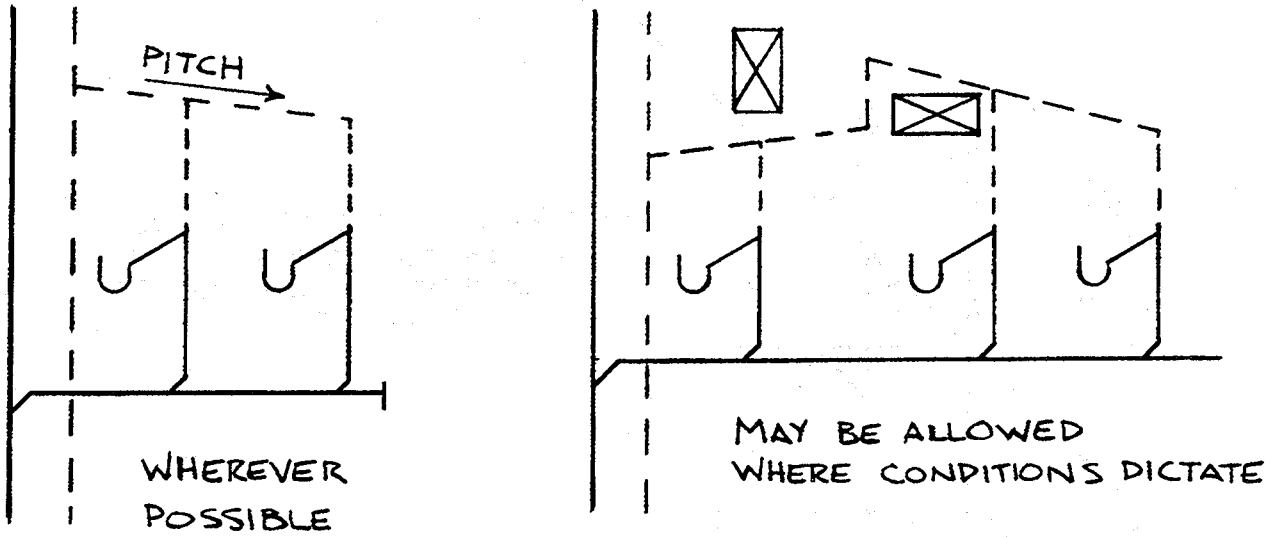

A-82.31 (15) (b) VENT GRADES AND CONNECTIONS.

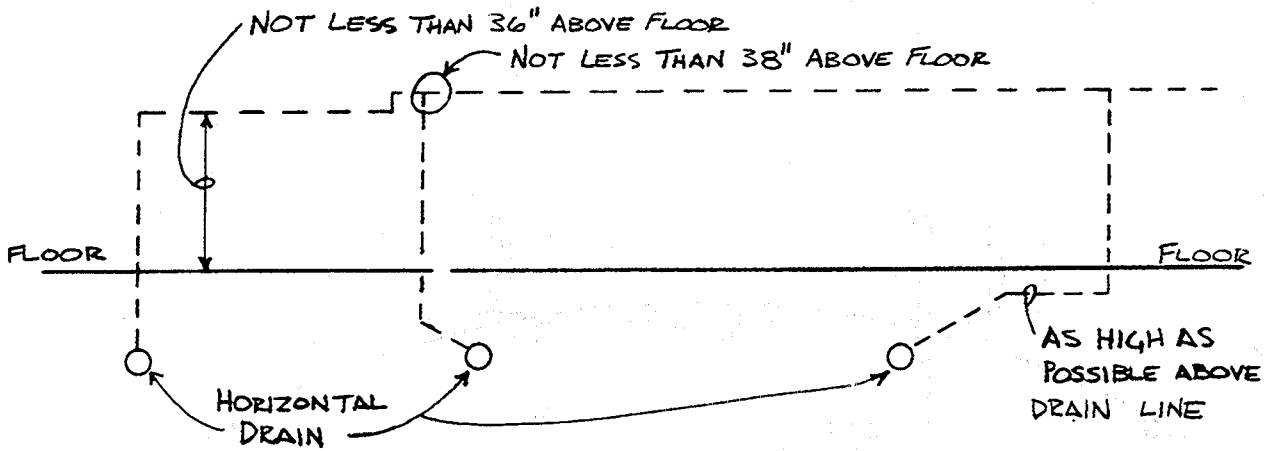

A-82.31 (16) VENT TERMINALS

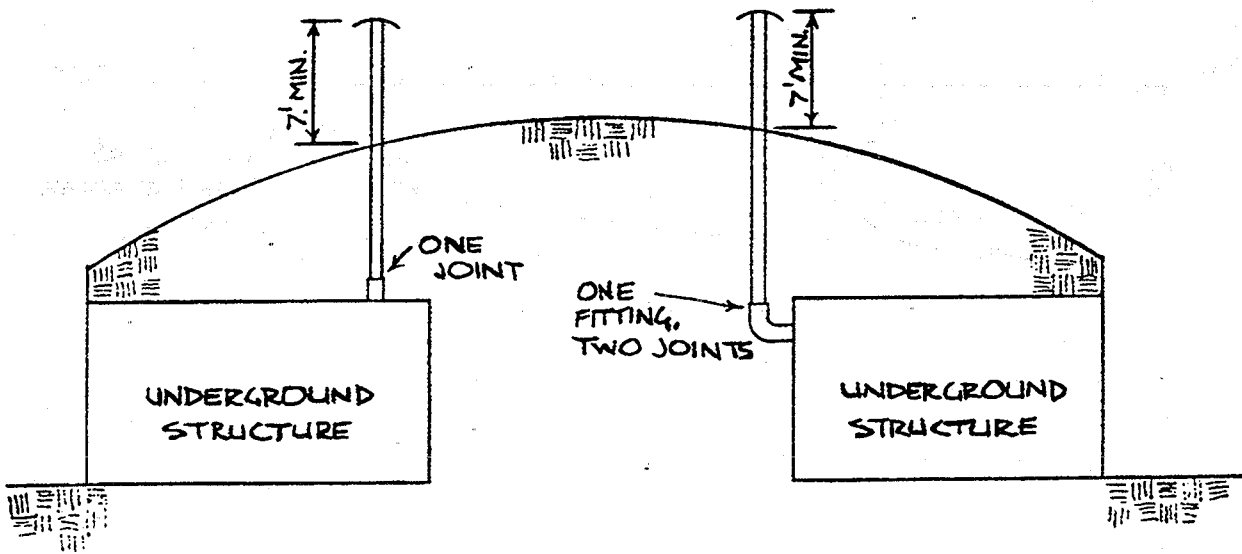
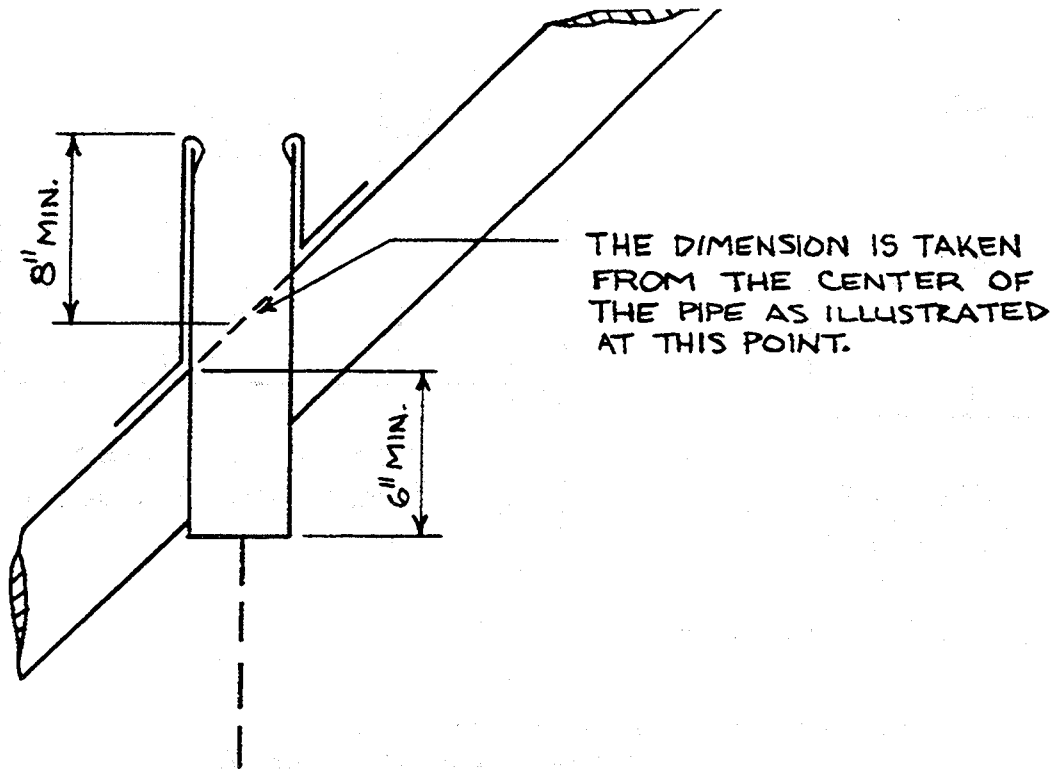

VENT TERMINALS FOR UNDERGROUND STRUCTURES



A-82.31 (17) (a) COMBINATION DRAIN AND VENT STACKS

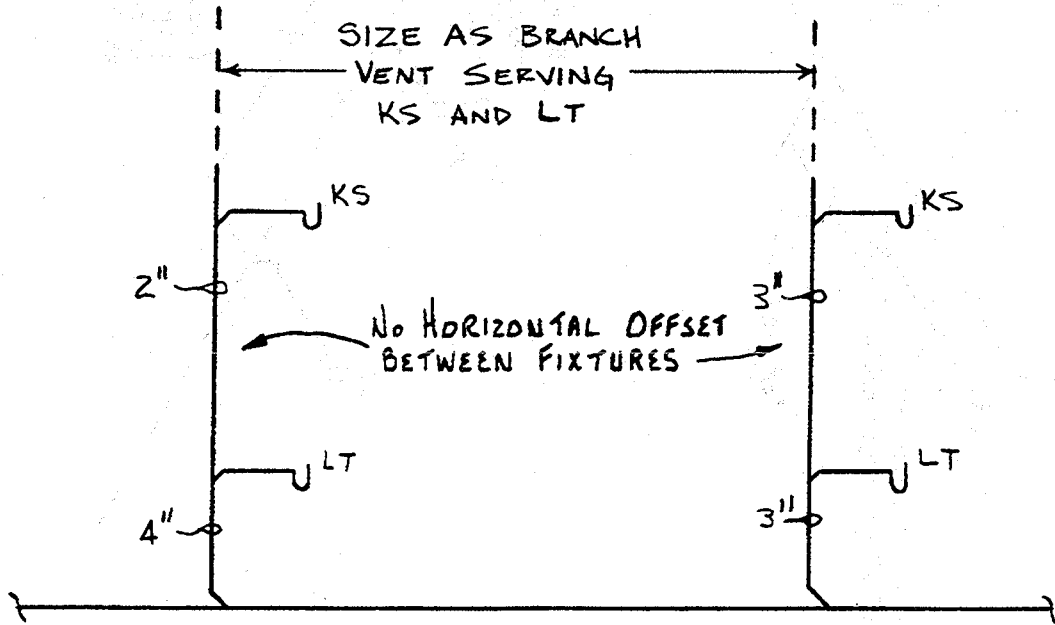
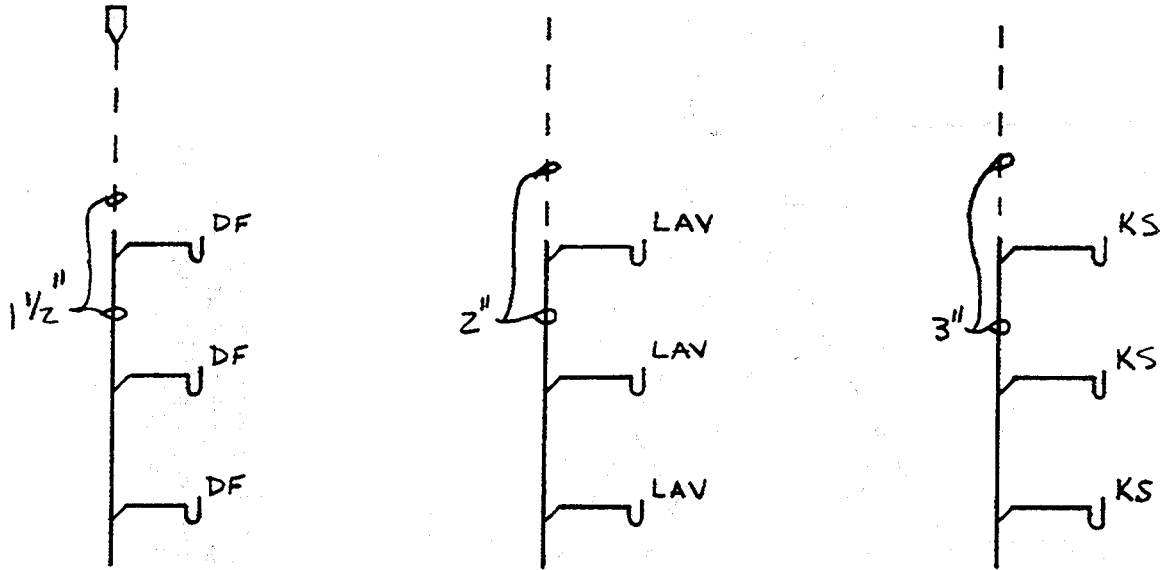

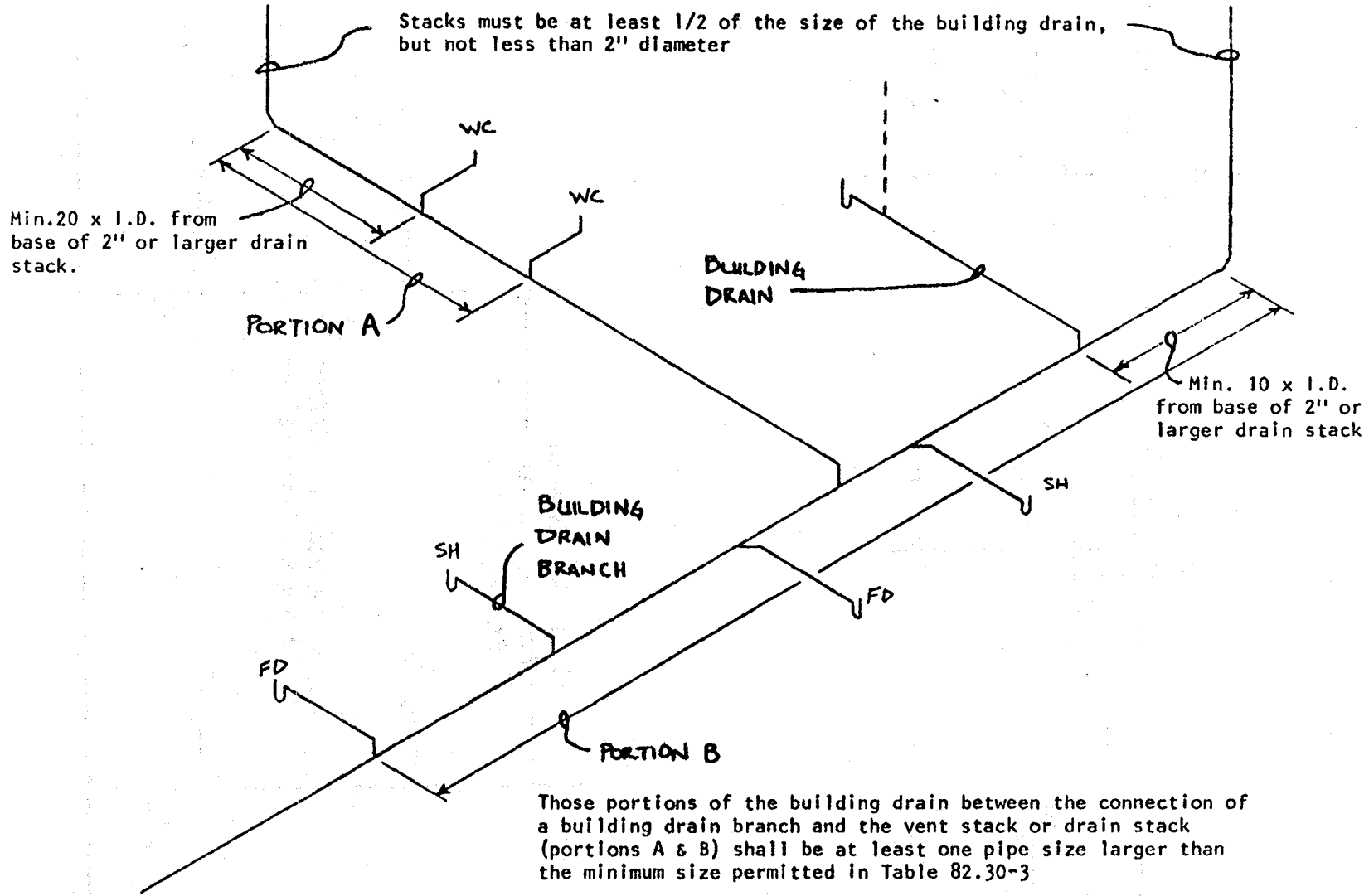

A-82.31 (17) (b) COMBINATION DRAIN AND VENT BUILDING DRAIN

A-82.31 (17) (c) COMBINATION DRAIN AND VENT LABORATORY SINK VENTING.

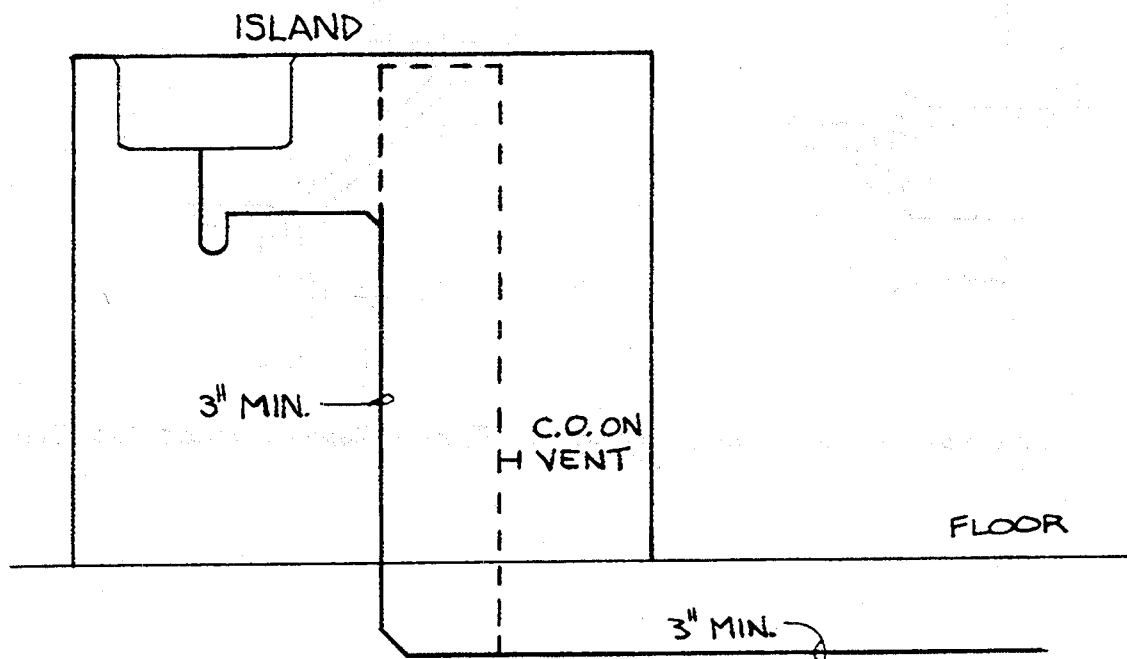
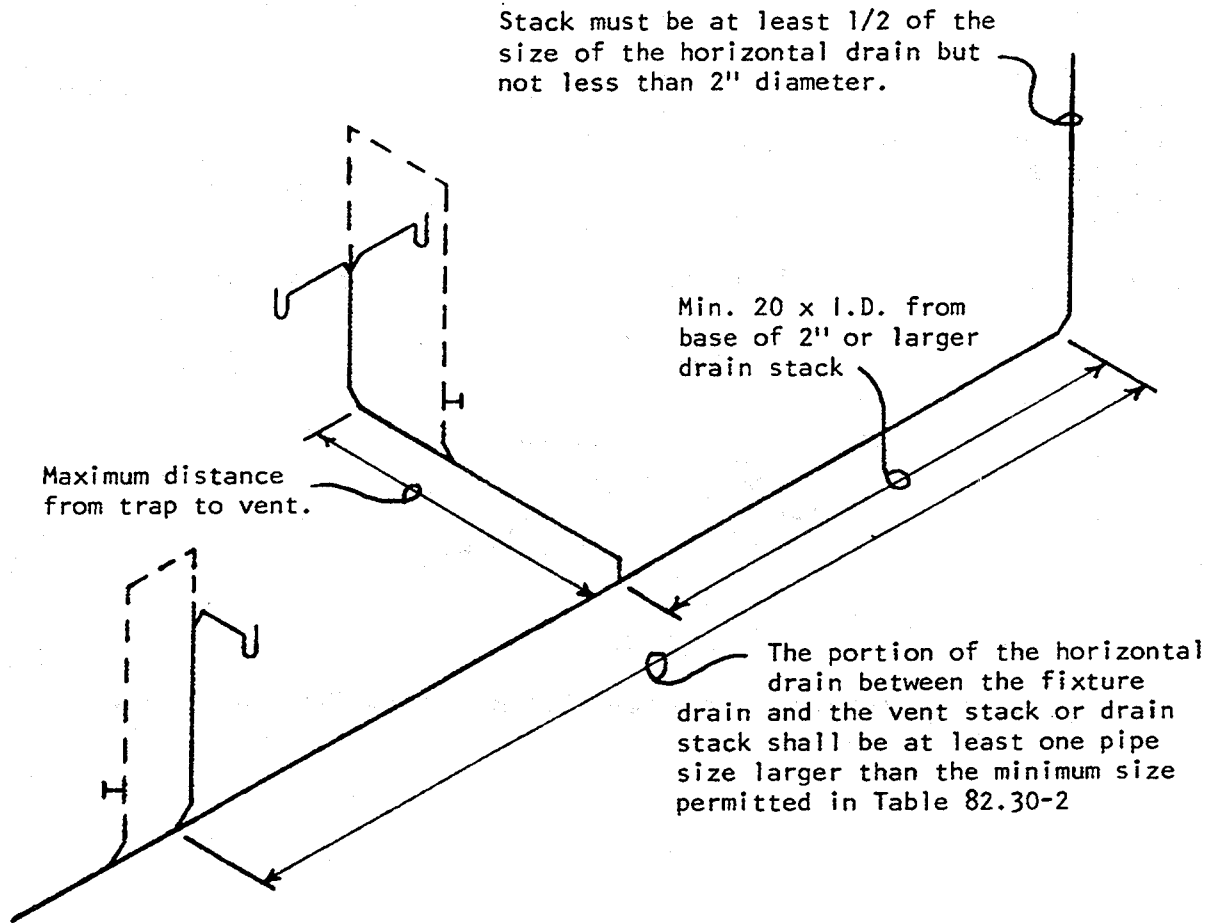

A-82.32 (4) (b) INSTALLATION OF TRAPS

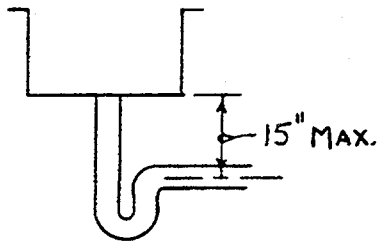

MOST FIXTURES

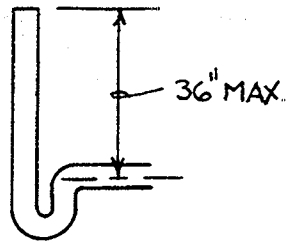

STANDPIPE

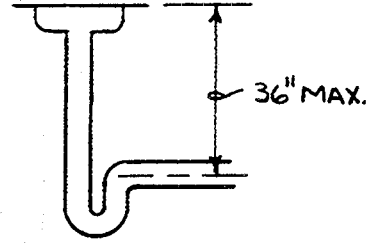

FLOOR DRAIN

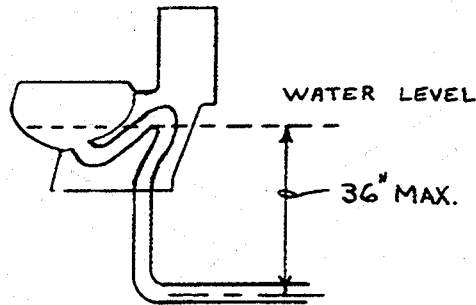

VERTICAL DISTANCE BETWEEN FIXTURE DRAIN OUTLET AND TRAP

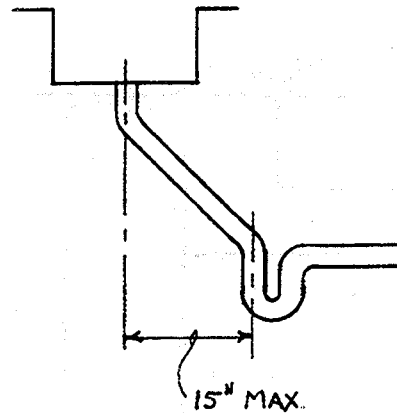
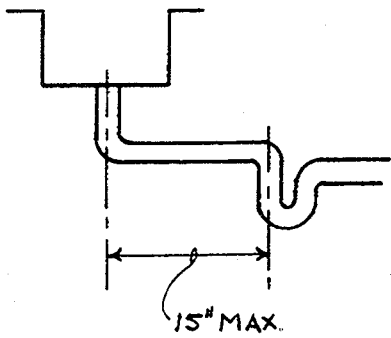

HORIZONTAL DISTANCE BETWEEN FIXTURE DRAIN OUTLET AND TRAP

A-82.33 (6) INDIRECT AND LOCAL WASTE PIPING.

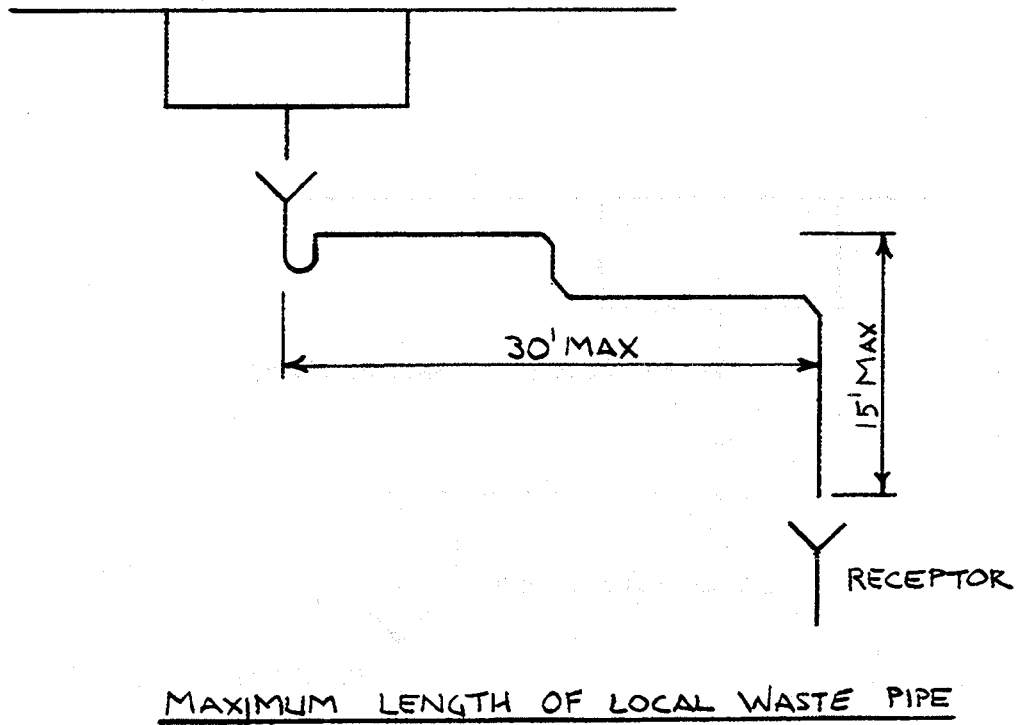
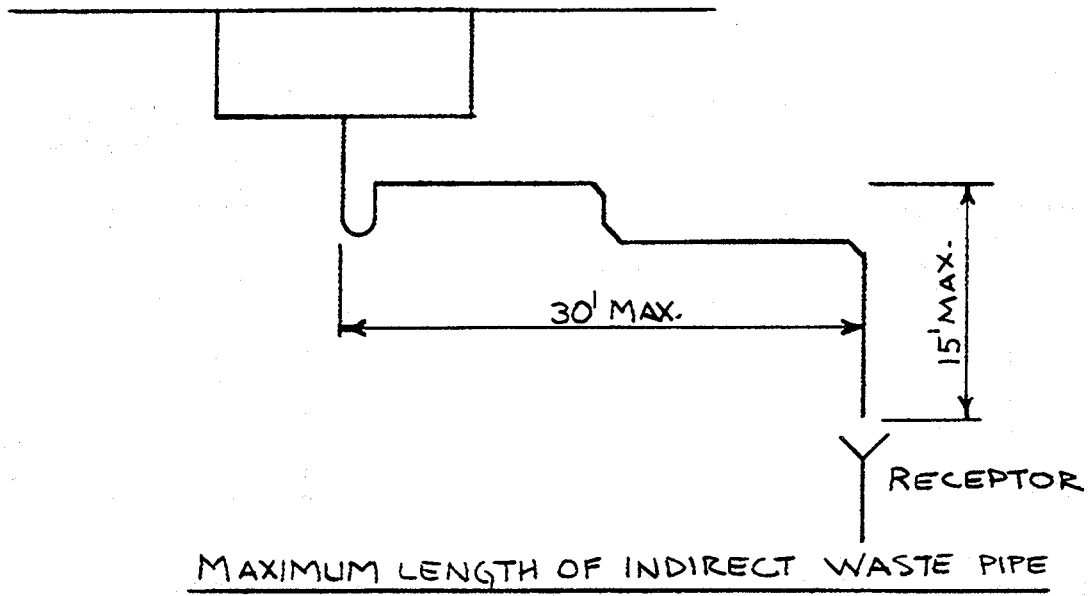

A-82.33 (7) AIR-GAPS AND AIR-BREAKS.

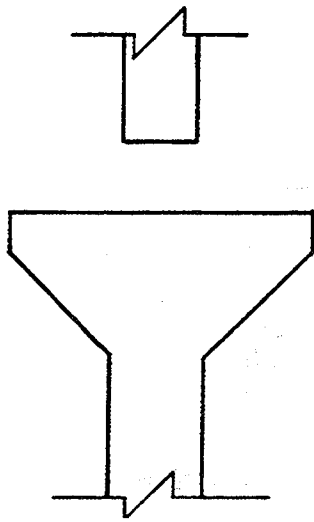

AIR GAP

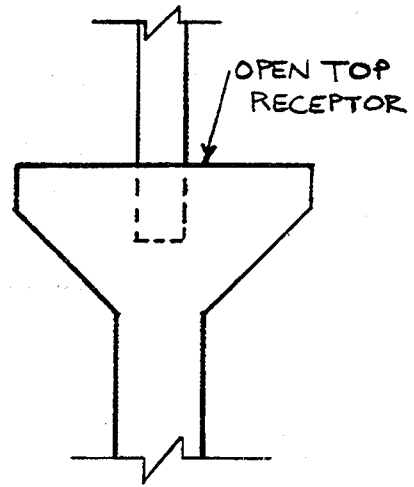

AIR BREAK

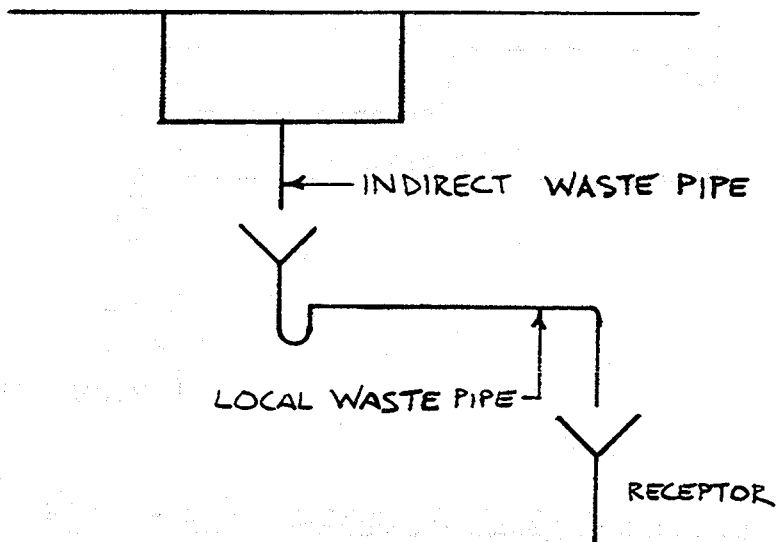

A-82.33 (8) (a) WASTE SINKS AND STANDPIPES

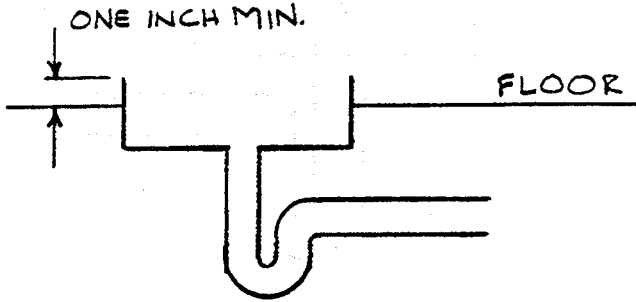

WASTE SINK IN FLOOR

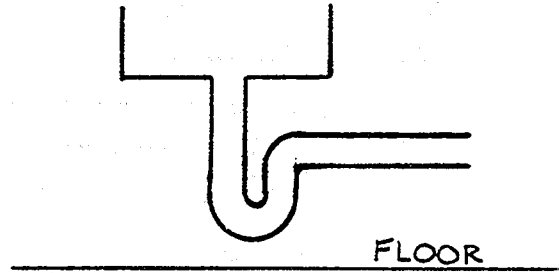

WASTE SINK ABOVE FLOOR

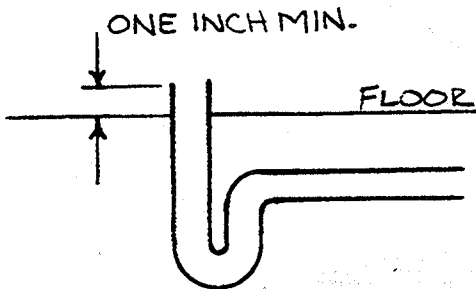

STANDPIPE IN FLOOR

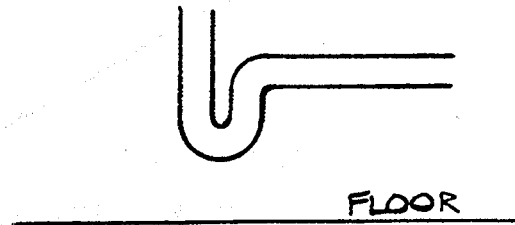

STANDPIPE ABOVE FLOOR

A-82.33 (8) (b) FLOOR SINKS

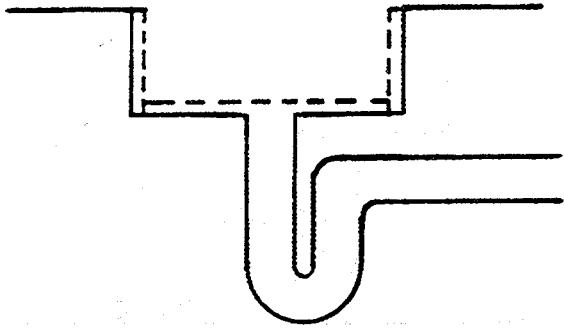

FLOOR SINK WITH BASKET

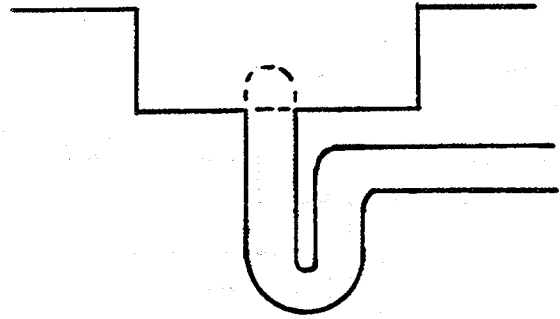

FLOOR SINK WITH DOME STRAINER

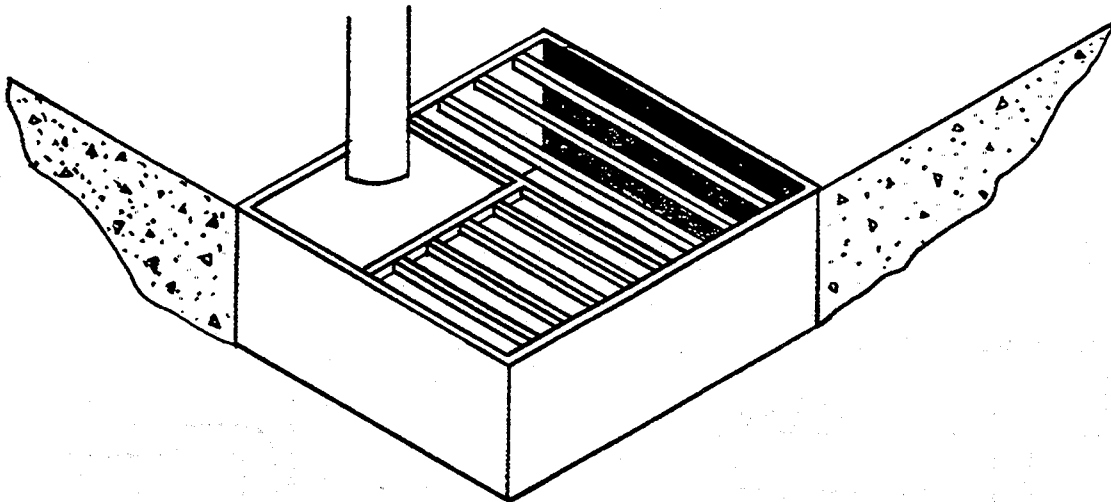

FLOOR SINK WITH GRATE OPENING  
FOR AIR GAP



A-82.33 (8) (c) LOCAL WASTE PIPING.

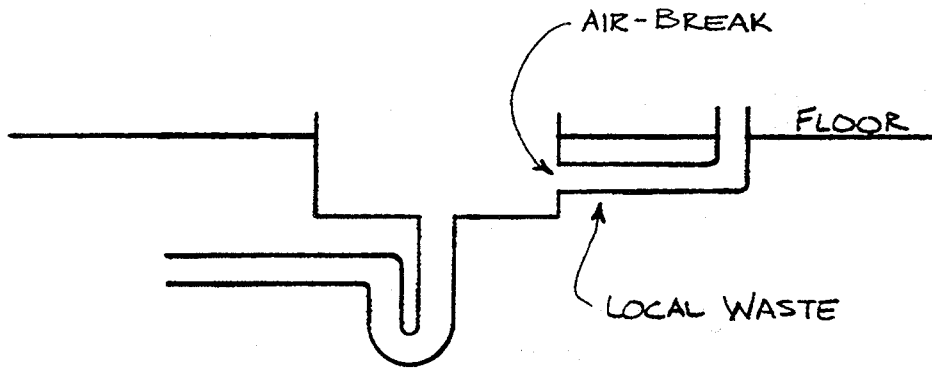

LOCAL WASTE LEADING TO A WASTE SINK,  
FLOOR SINK OR FLOOR DRAIN

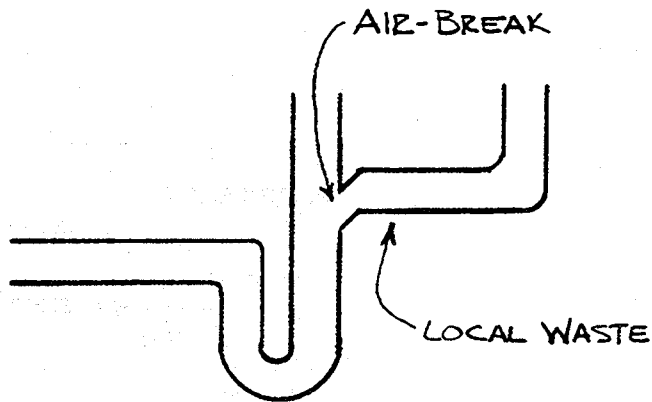

LOCAL WASTE LEADING TO A STANDPIPE

A-82.33 (8) (c) LOCAL WASTE PIPING SERVING WATER HEATER RELIEF VALVES.

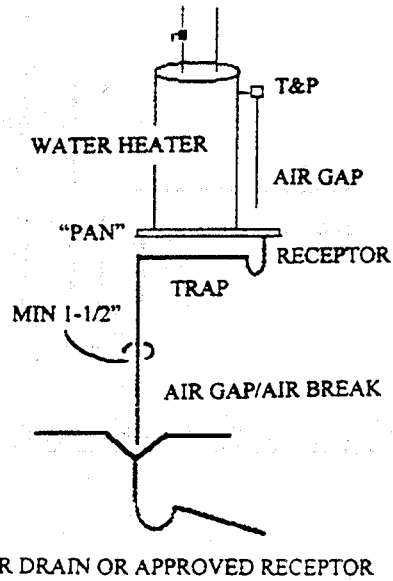
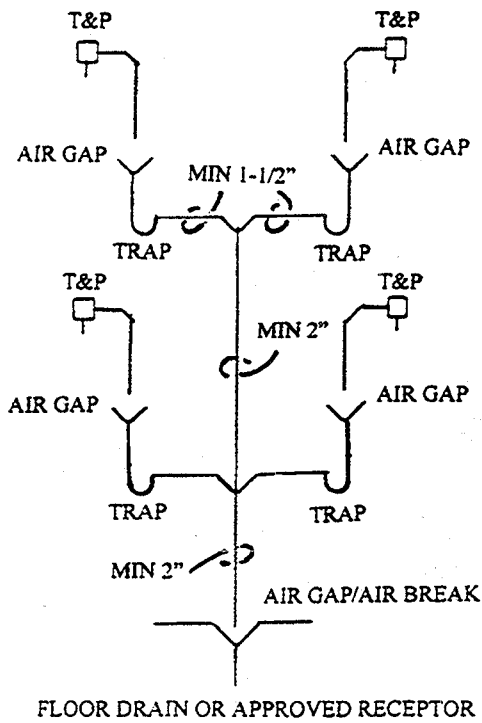
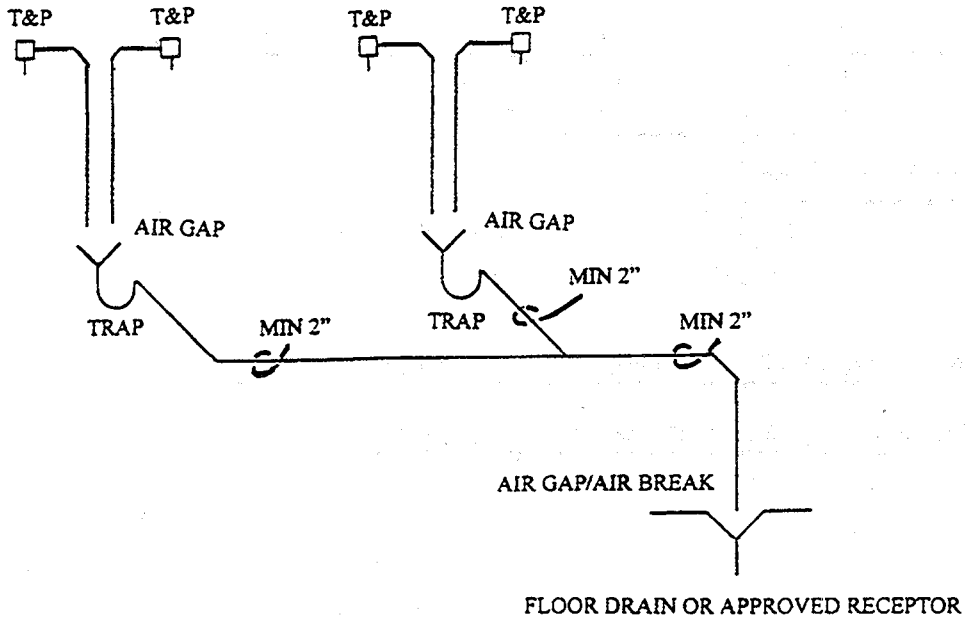

A-82.33 (9) (c) COMMERCIAL GRAVITY DISCHARGE-TYPE CLOTHES WASHERS

TRENCH TYPE LAUNDRY RECEPTOR

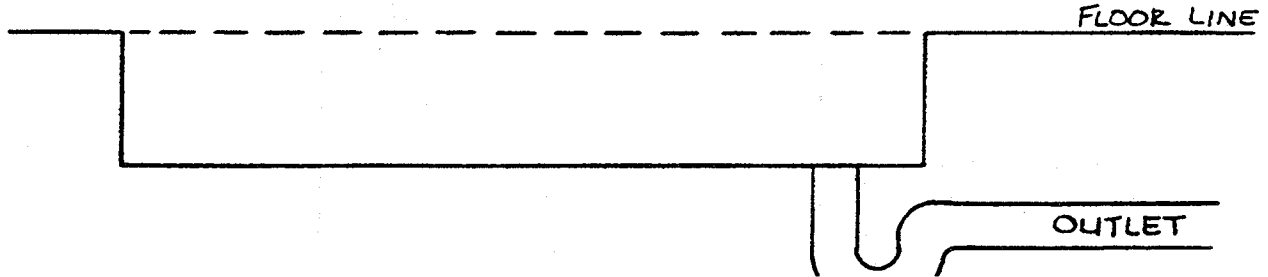

A-82.33 (9) (d) RESIDENTIAL-TYPE DISHWASHERS

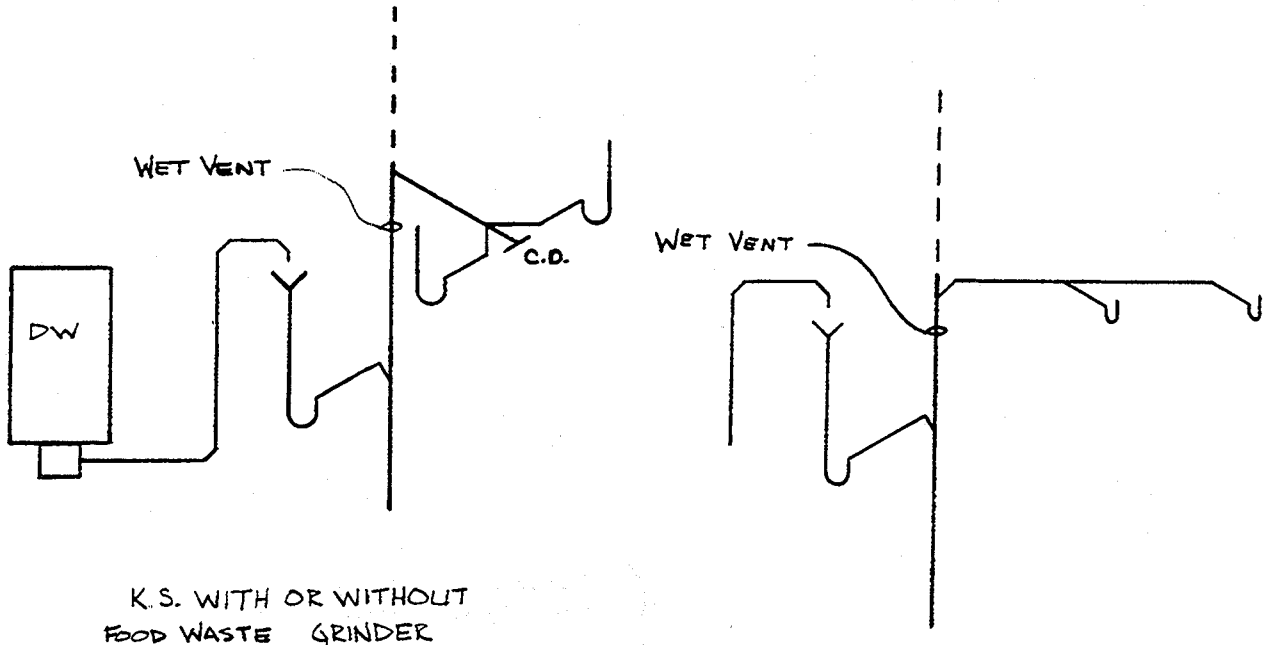

K.S. WITH OR WITHOUT  
FOOD WASTE GRINDER

K.S. WITH OR WITHOUT  
FOOD WASTE GRINDER

DISWASHER DISCHARGING TO A STANDPIPE  
BELOW THE COUNTER TOP.

A-82.33 (9) (d) RESIDENTIAL-TYPE DISHWASHERS

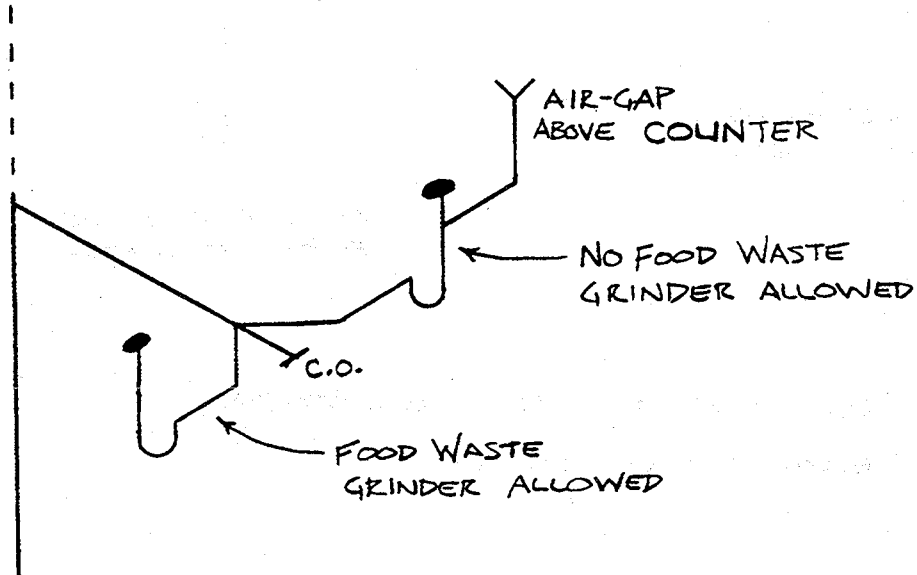
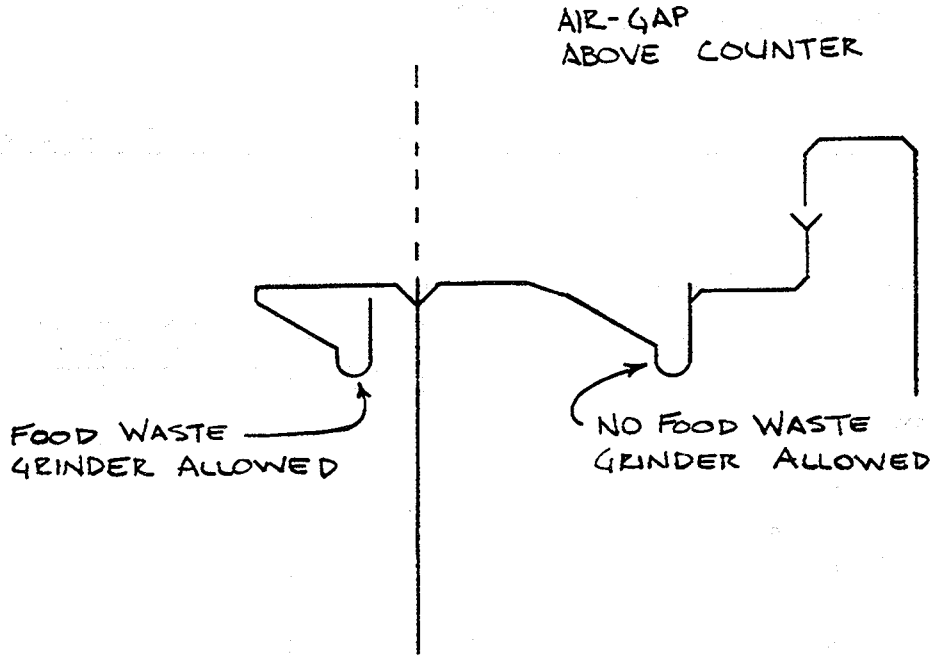

A-82.33 (9) (d) RESIDENTIAL-TYPE DISHWASHERS.

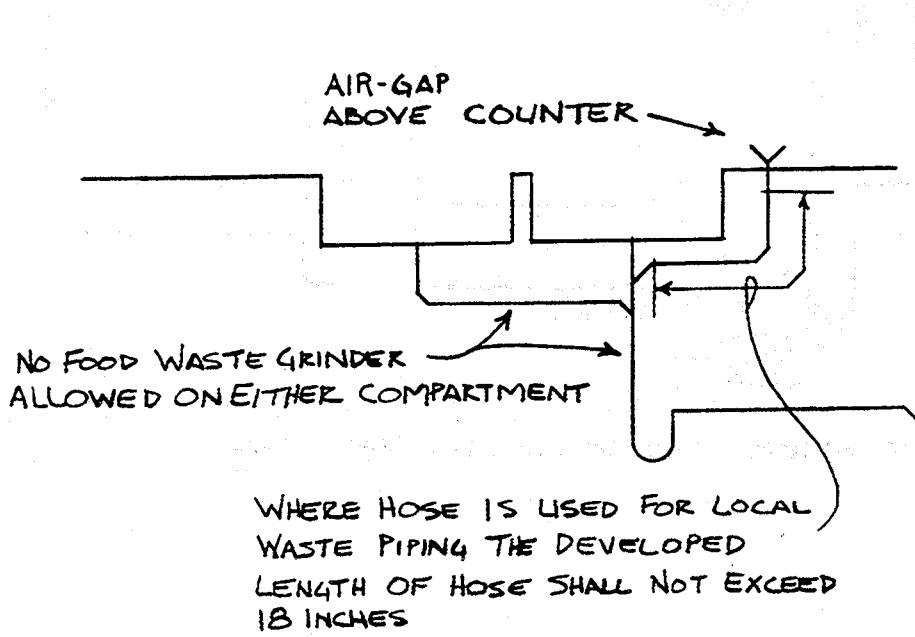
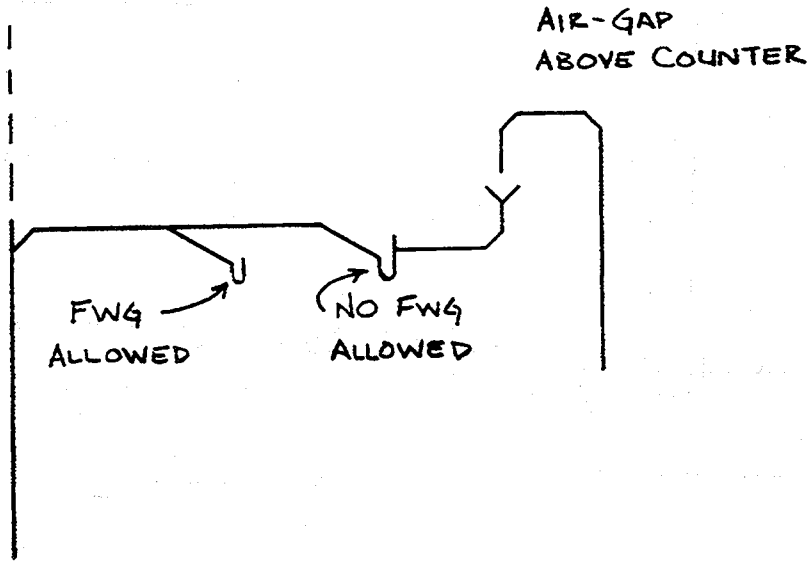

A-82.33 (9) (d) COMMERCIAL DISHWASHERS

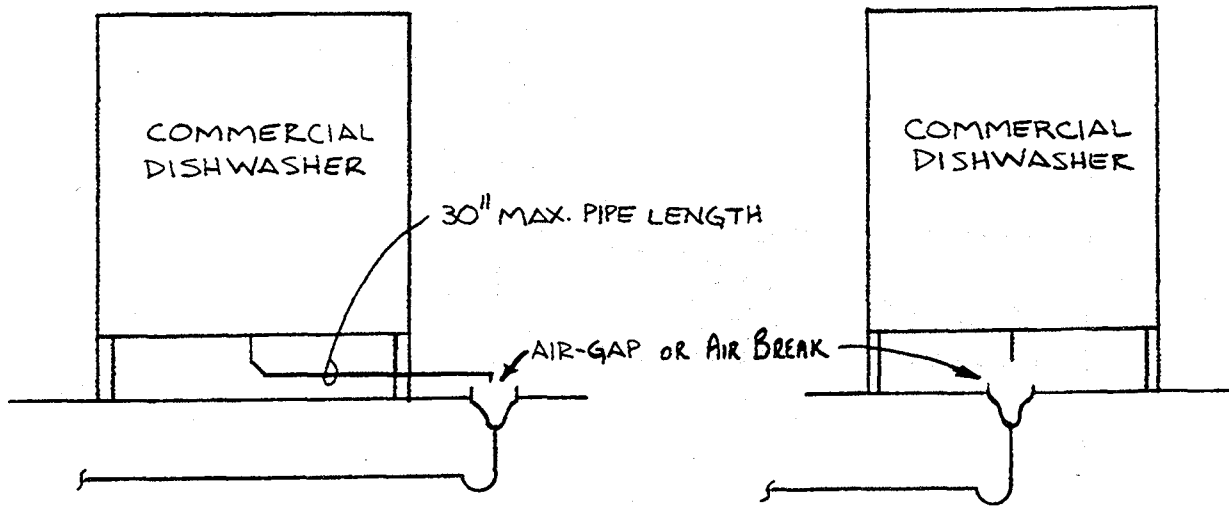

A-82.33 (9) (f) ELEVATOR PIT SUBSOIL AND FLOOR DRAINS.

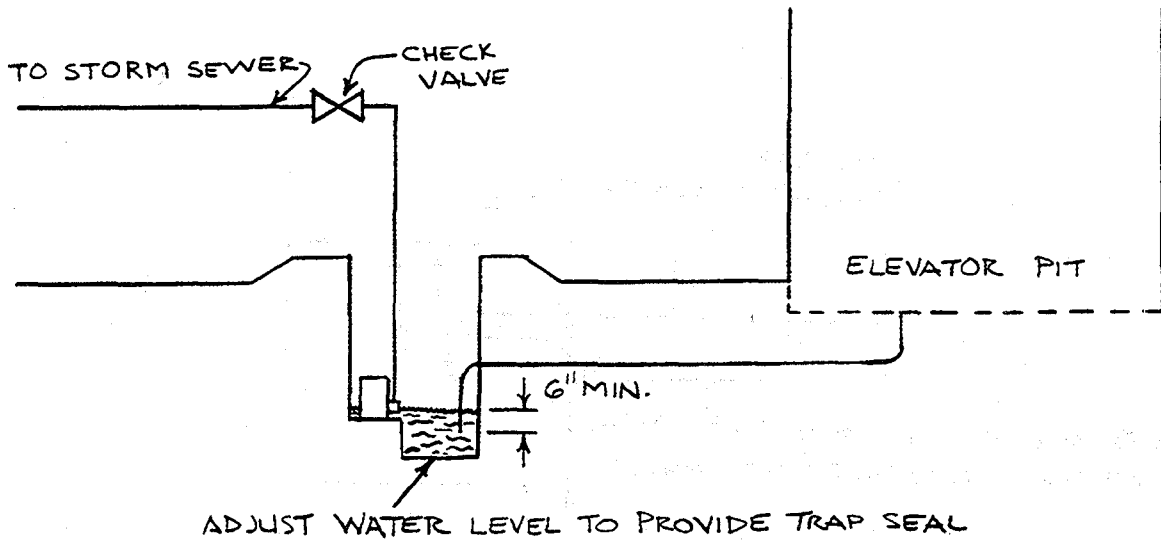

A-82.33 (9) (g) 1. BAR AND SODA FOUNTAIN SINKS

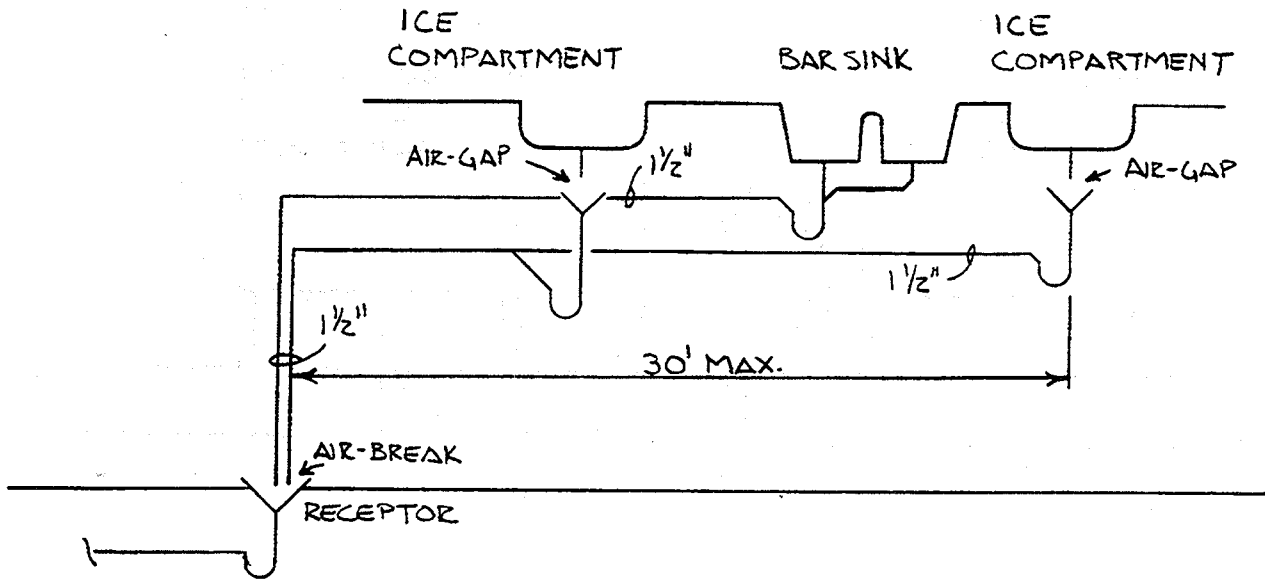

A-82.33 (9) (g) 2. BEER TAPS, COFFEE MAKERS, GLASS FILLERS AND SODA DISPENSERS.

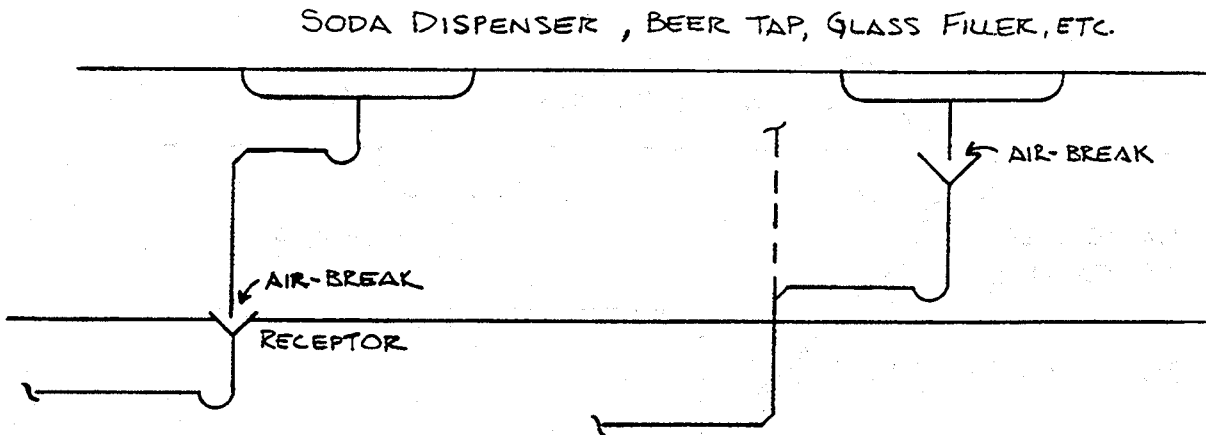

A-82.33 (9) (g) 3. NOVELTY BOXES, AND ICE COMPARTMENTS AND ICE CREAM DIPPER WELLS.

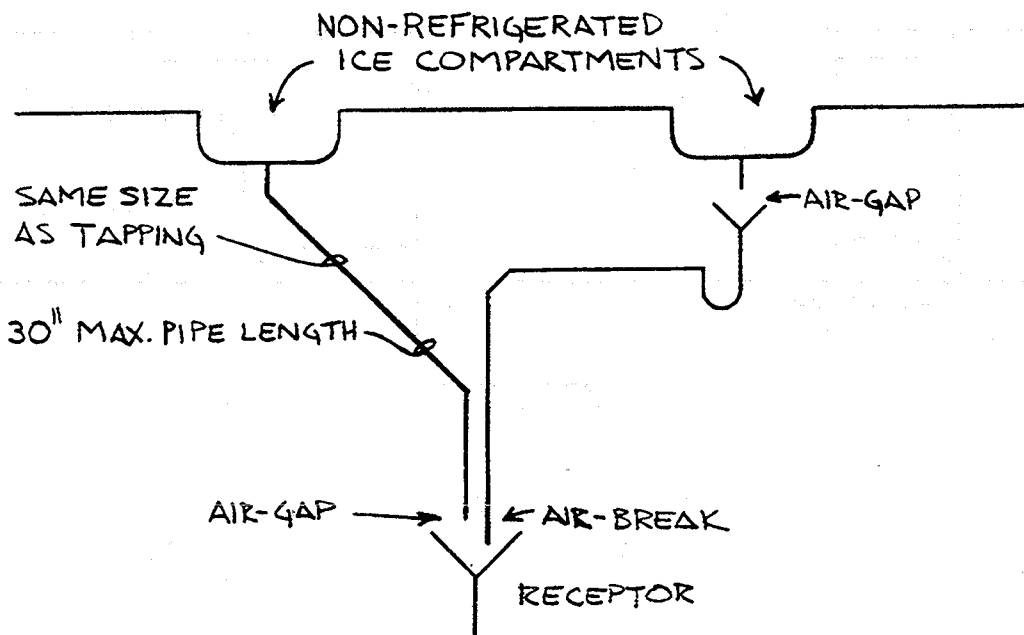
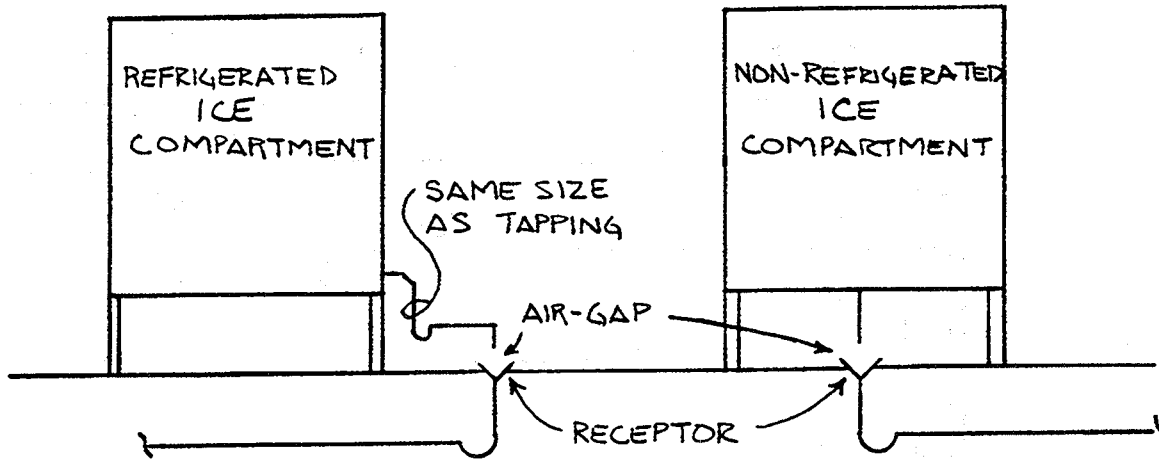



A-82.33 (9) (g) 4. REFRIGERATED FOOD STORAGE ROOMS, COMPARTMENTS, AND DISPLAY CASES.

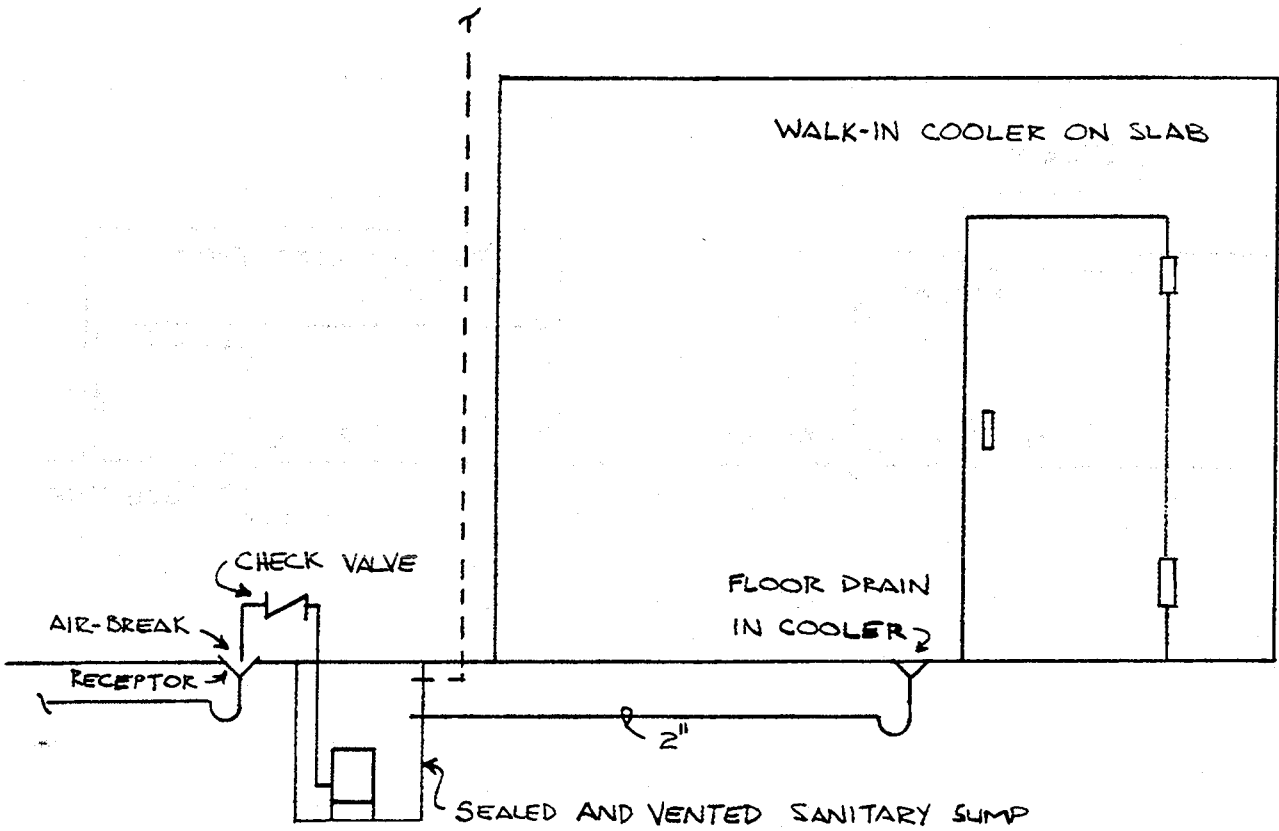
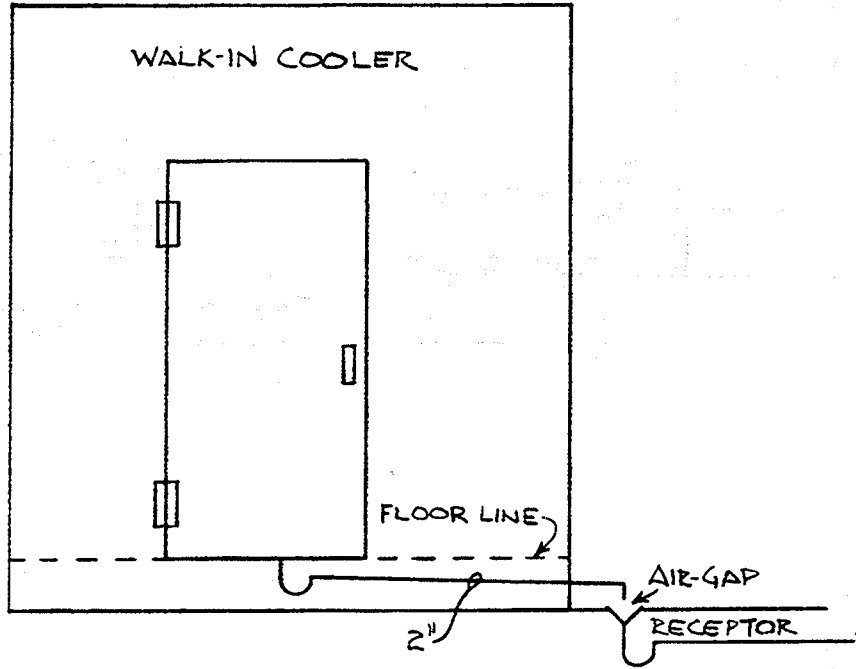

A-82.33 (9) (g) 5. MISCELLANEOUS FOOD HANDLING EQUIPMENT.

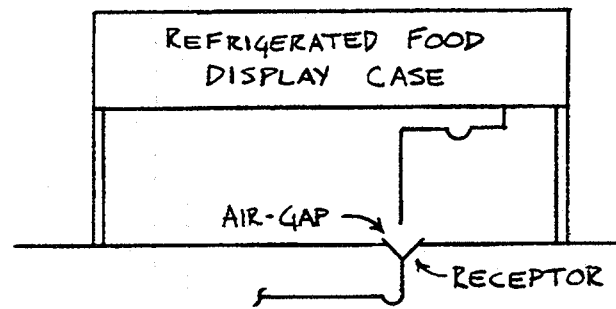
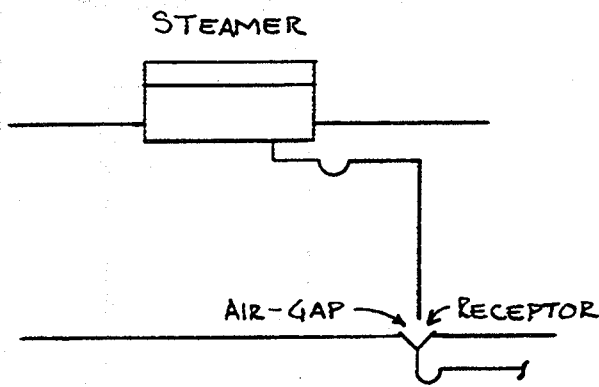
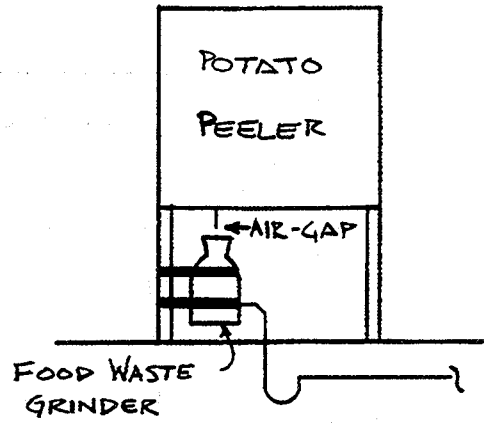
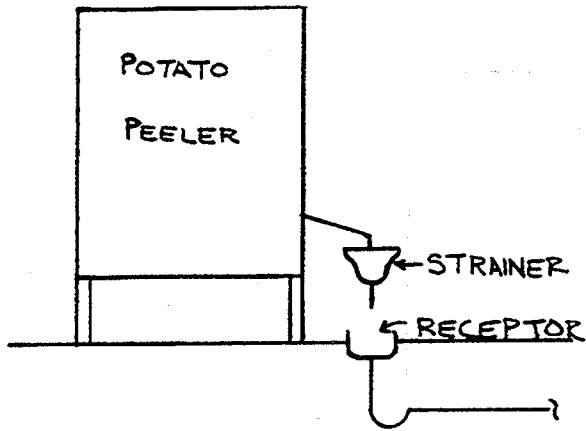

A-82.33 (9) (g) 5. MISCELLANEOUS FOOD HANDLING EQUIPMENT.

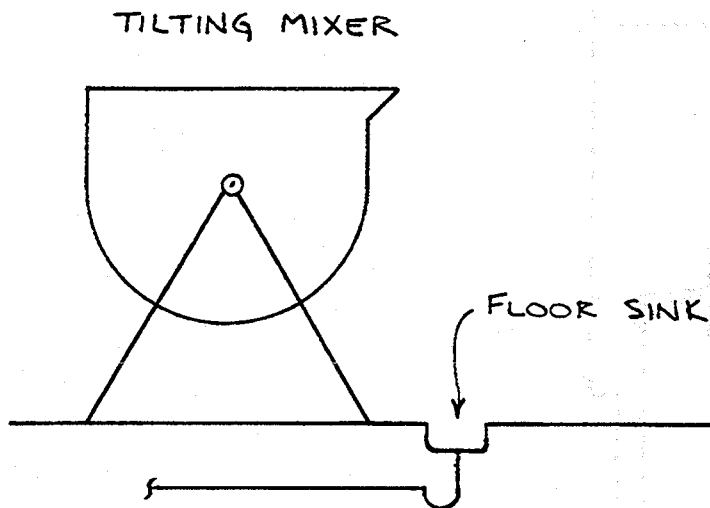
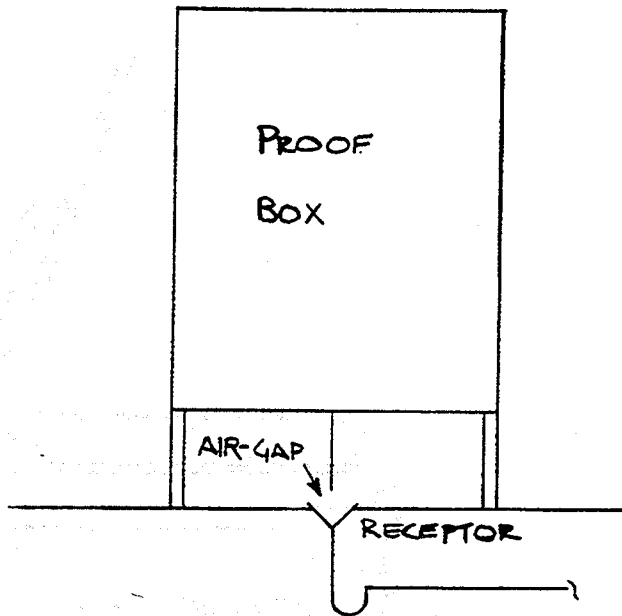

A-82.33 (9) (g) 5. MISCELLANEOUS FOOD HANDLING EQUIPMENT

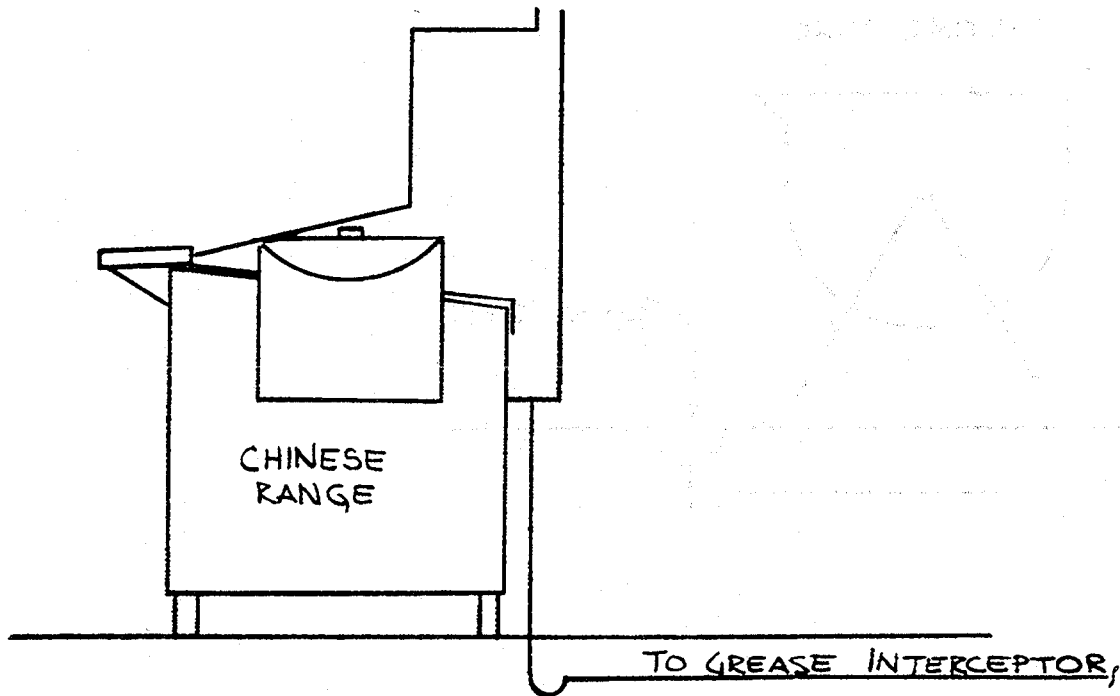
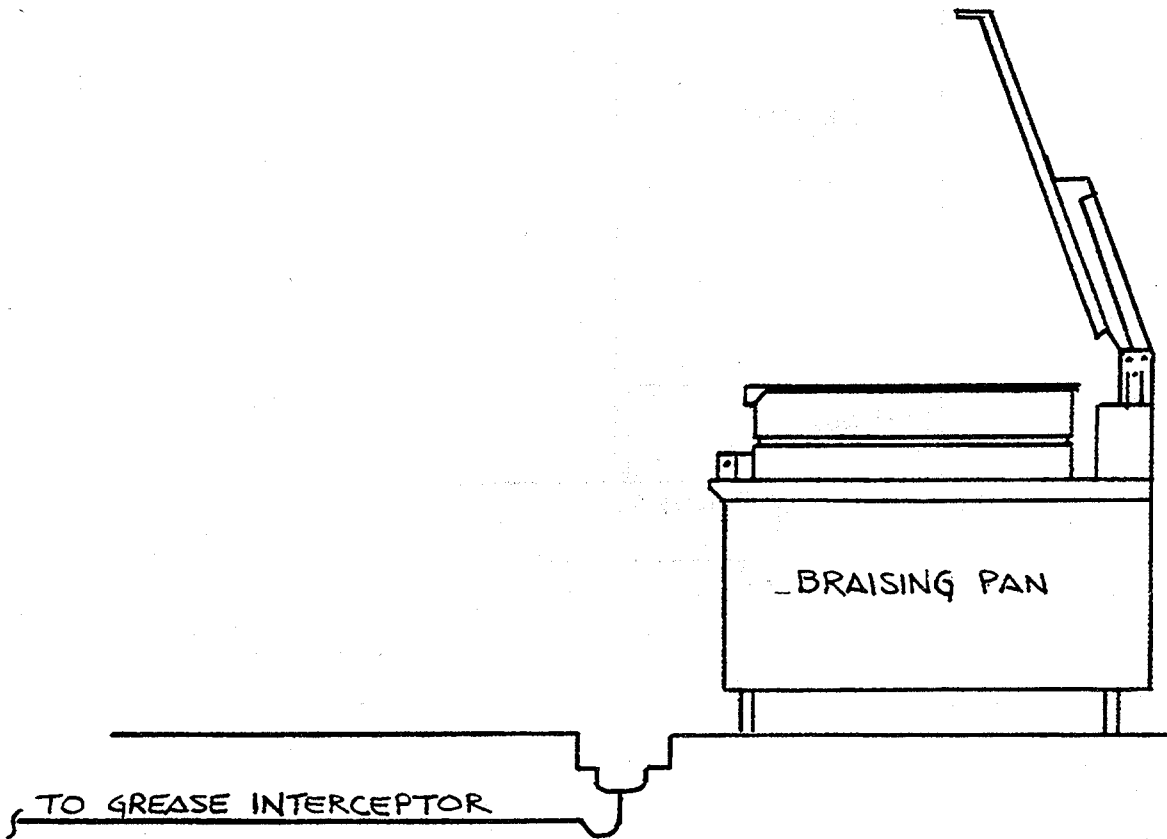

A-82.33 (9) (g) 5. MISCELLANEOUS FOOD HANDLING EQUIPMENT

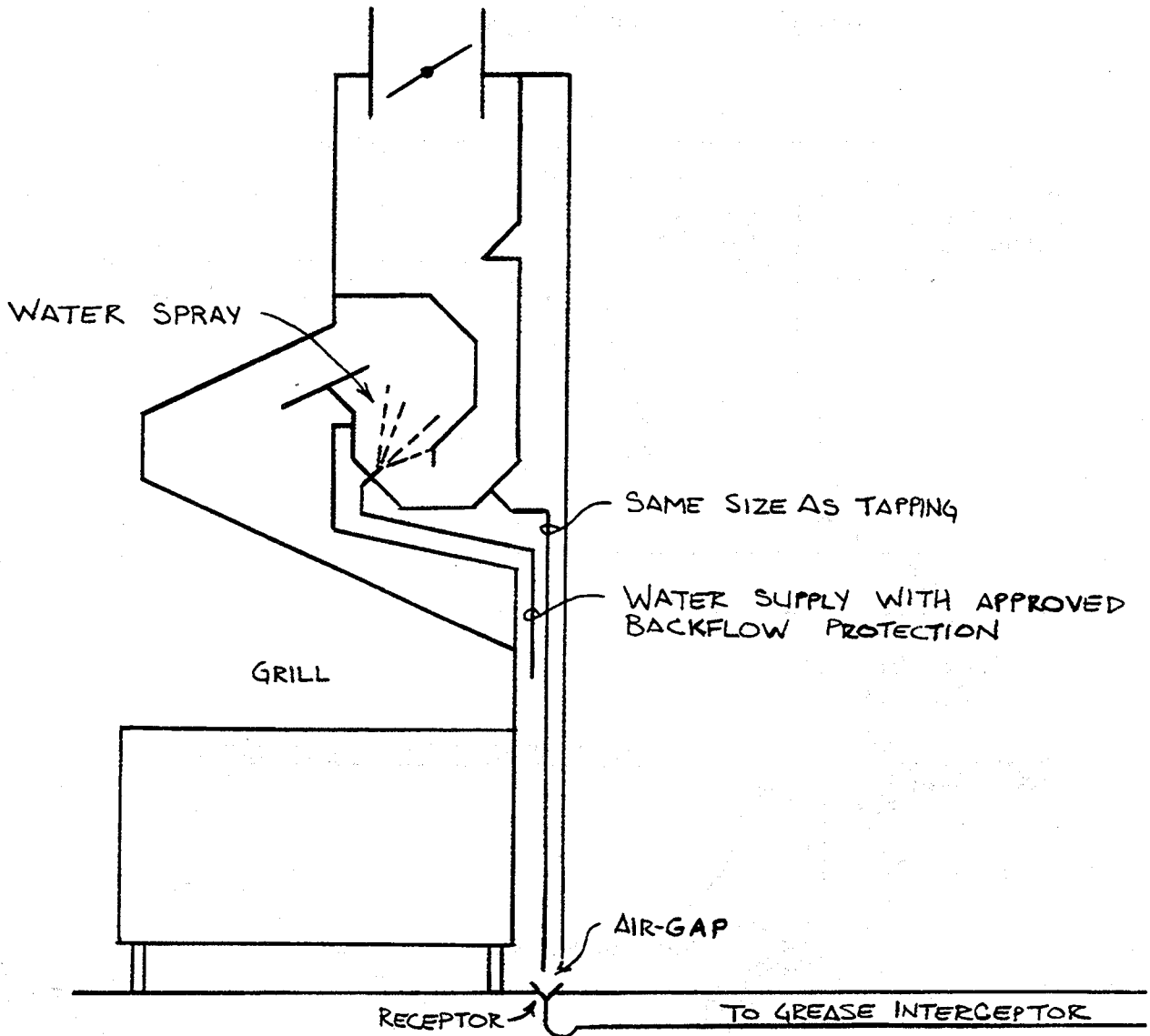

EXHAUST HOOD WASHER

A-82.34 (4) (a) PUBLIC BUILDINGS.

### GARAGE CATCH BASIN

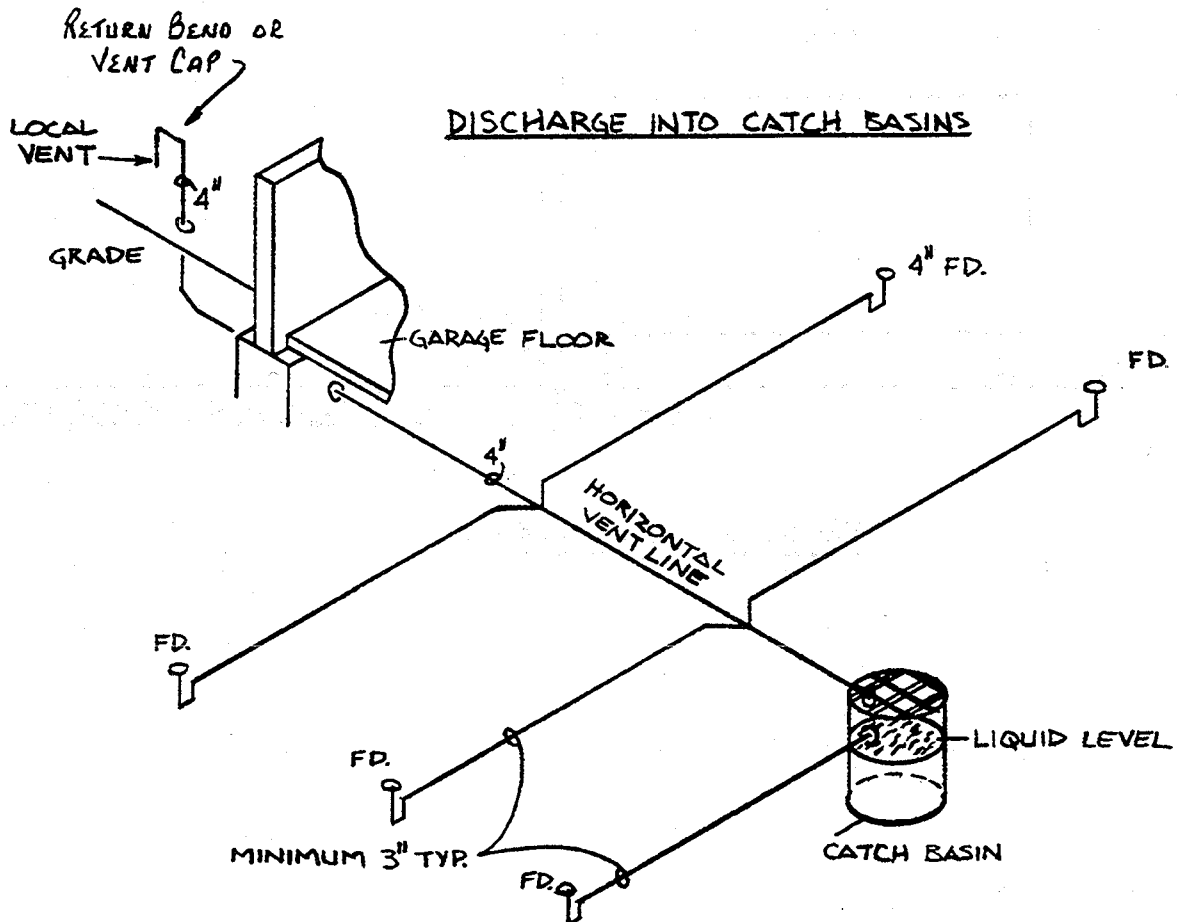
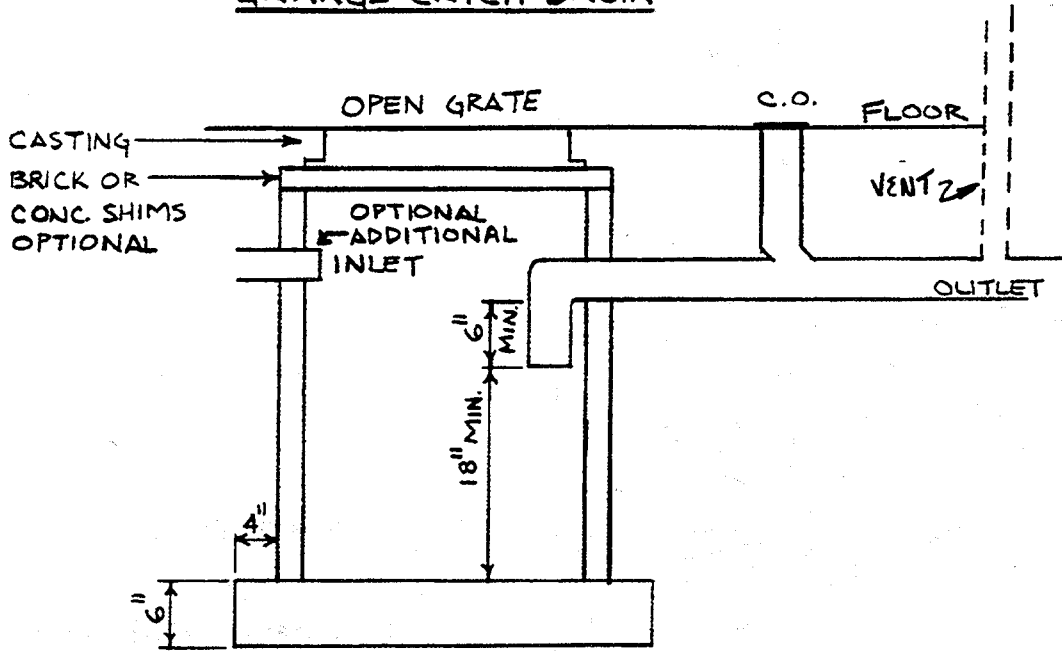

A-82.34 (4) (a) PUBLIC BUILDINGS.

Diameter of Catch Basin	Volume in cubic feet per foot of depth	Diameter of Catch Basin	Volume in cubic feet per foot of depth
36	7.1	45	11.1
37	7.5	46	11.6
38	7.9	47	12.1
39	8.3	48	12.6
40	8.7	54	15.9
41	9.2	60	19.7
42	9.7	66	23.8
43	10.1	72	28.3
44	10.6	84	38.6

A-82.34 (4) (a) PUBLIC BUILDINGS.

TRENCH DRAINS

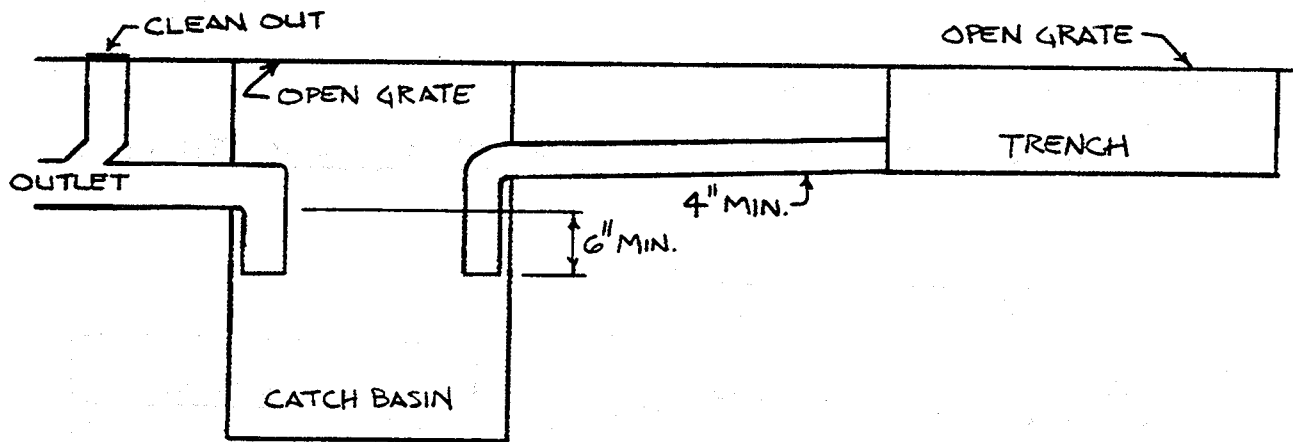

A-82.34 (4) (b) GARAGES FOR ONE- AND 2-FAMILY DWELLINGS.

TYPICAL FLOOR DRAIN WITH SOLID BOTTOM SEDIMENT BASKET

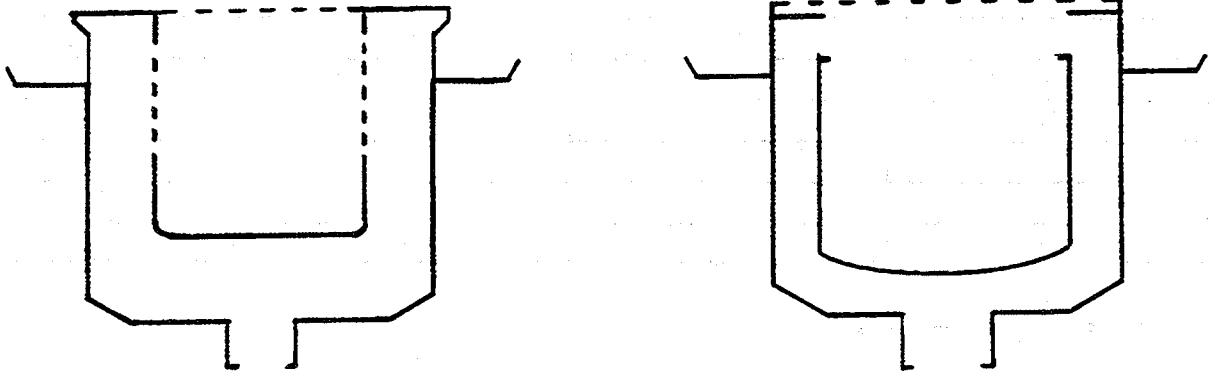

A-82.34 (5) (b) EXTERIOR GREASE INTERCEPTORS.

GREASE INTERCEPTOR MANHOLE LOCATION

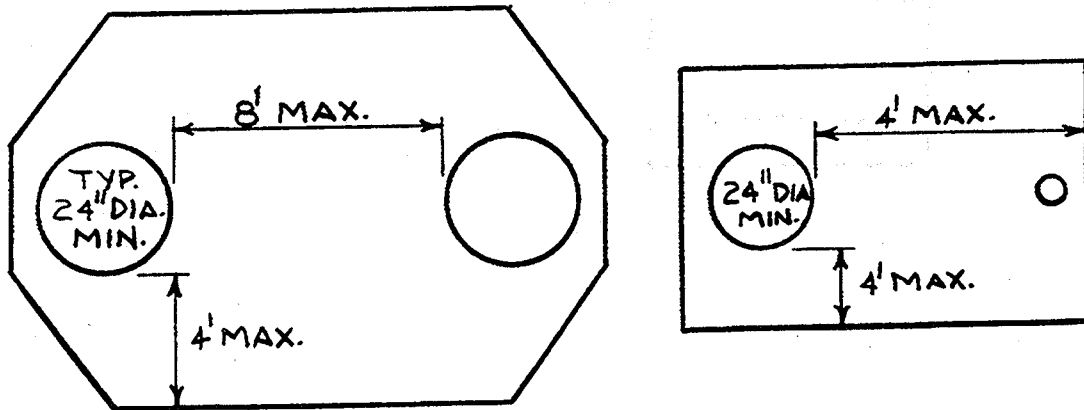



A-82.34 (5) (b) EXTERIOR GREASE INTERCEPTORS

EXTERIOR GREASE INTERCEPTOR

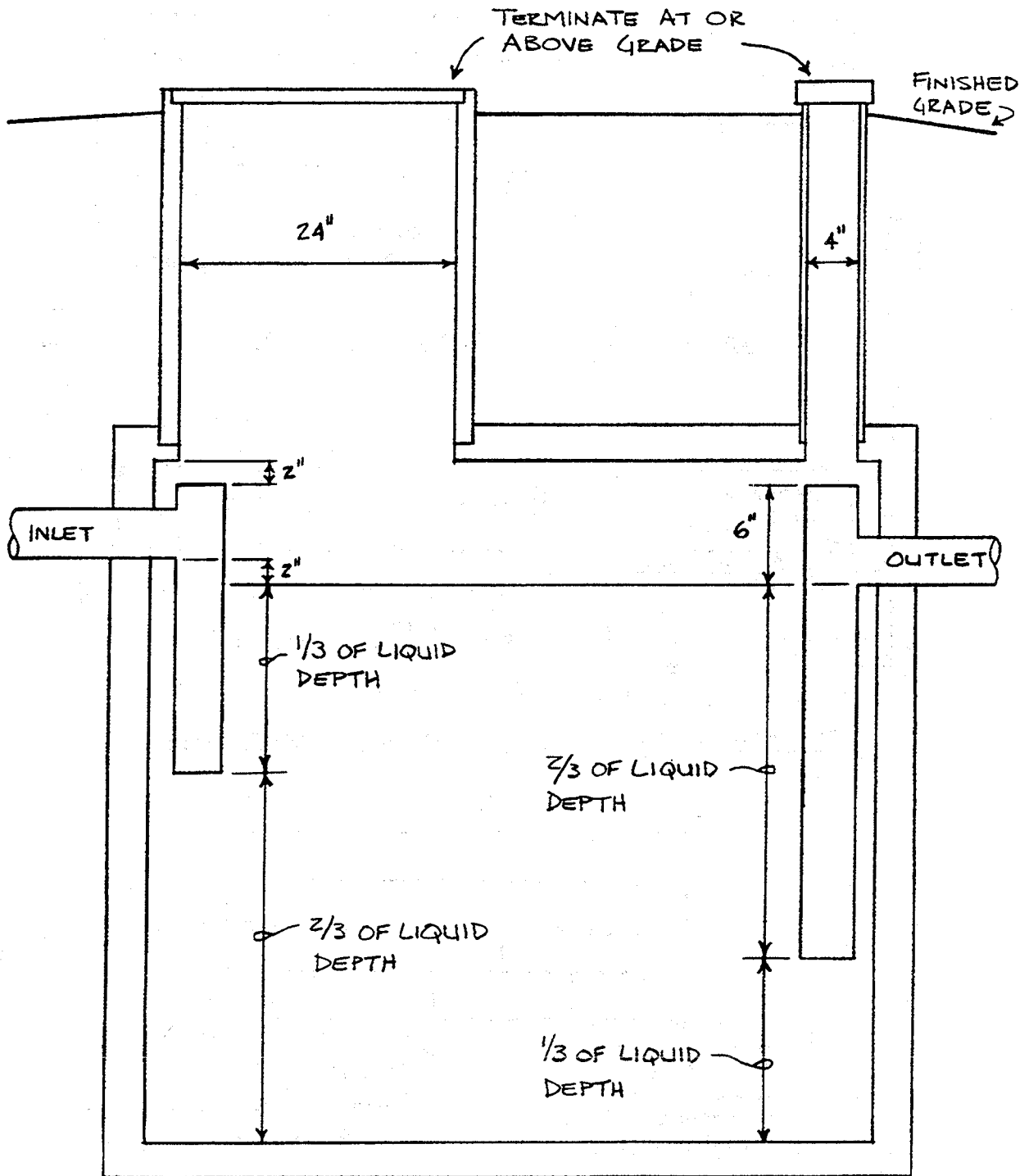

A-82.34 (5) (c) INTERIOR GREASE INTERCEPTORS.

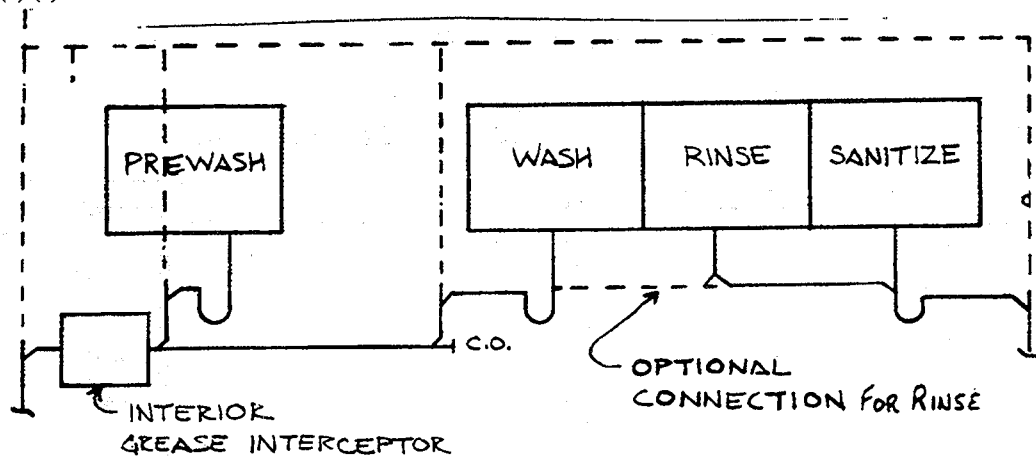

PREWASH AND 3 COMPARTMENT SCULLERY SINK

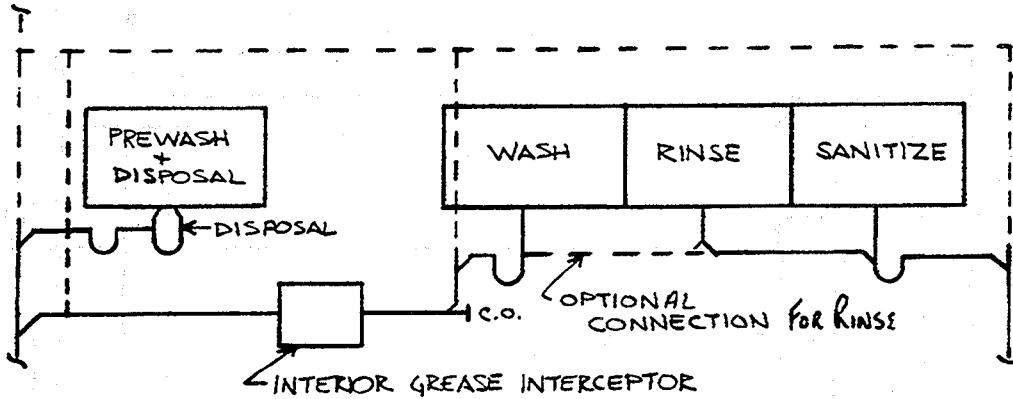

PREWASH + DISPOSAL + 3 COMPARTMENT SCULLERY SINK

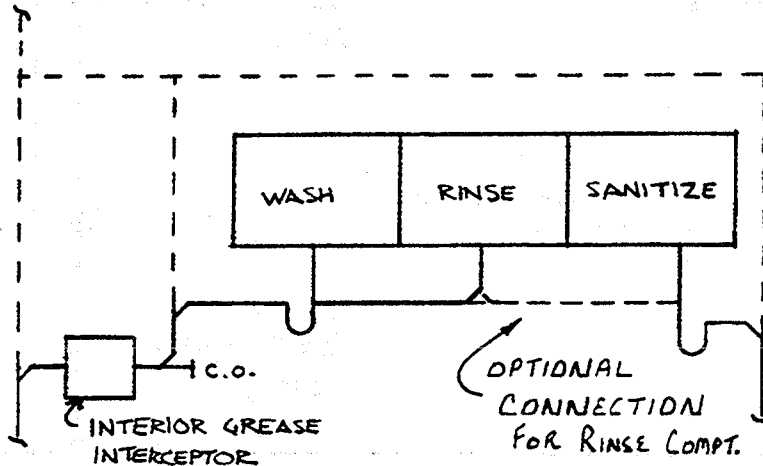

3 COMPARTMENT SCULLERY SINK

Note: Rinse and sanitize compartments and garbage disposals may discharge through interior grease interceptors.

A-82.34 (6) AUTOMATIC CAR WASHES

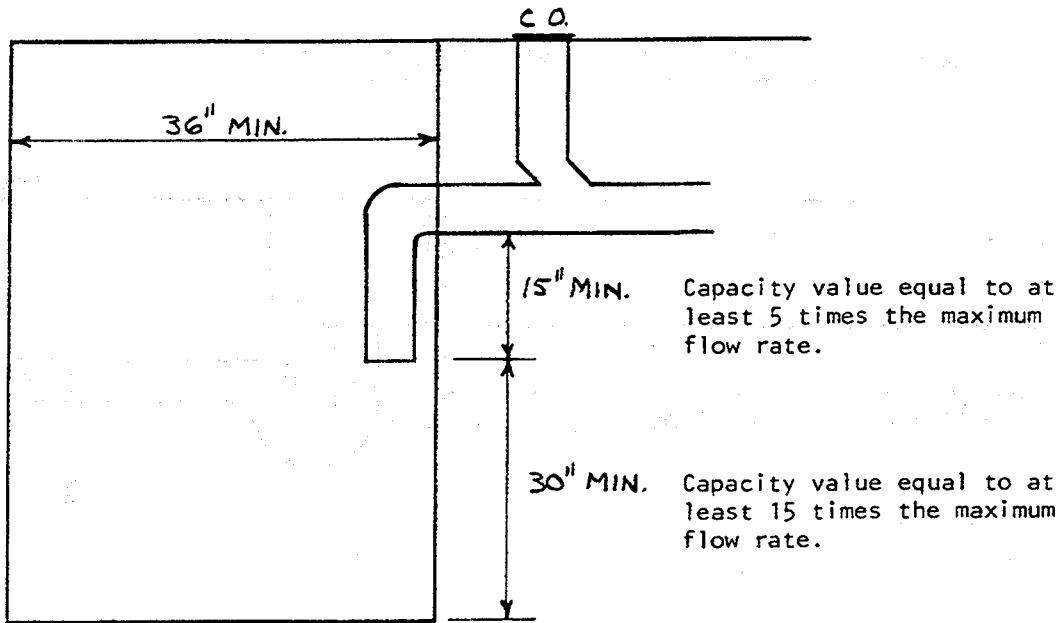

CAR WASH INTERCEPTOR WITH INVERT INSIDE OF BASIN

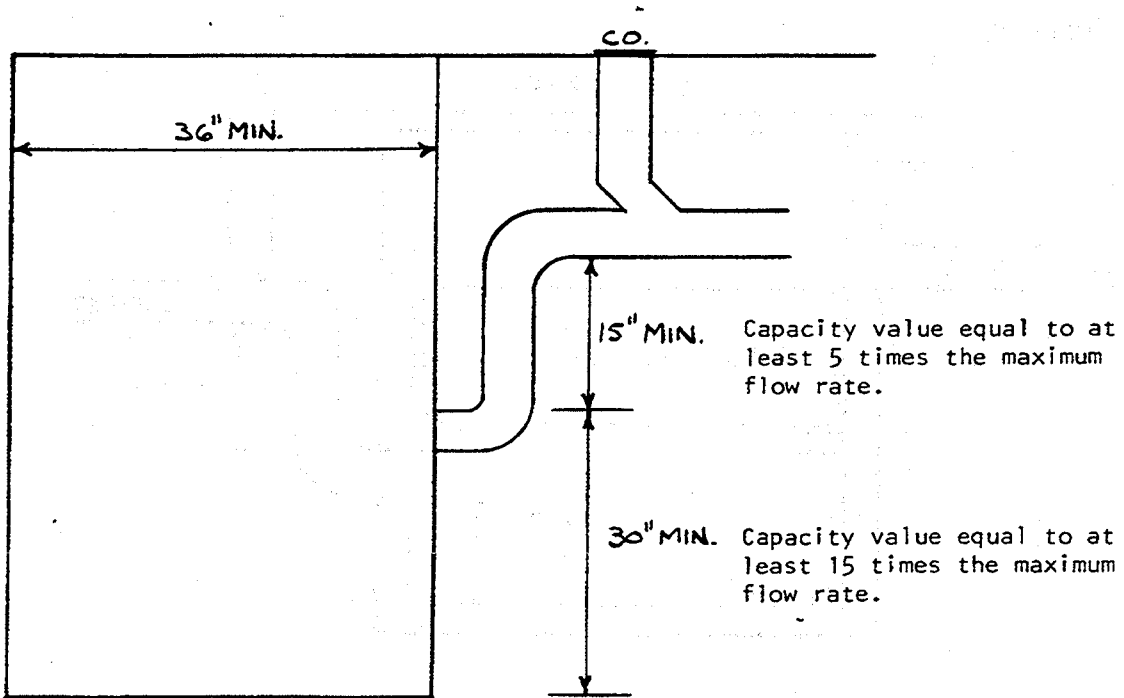

CAR WASH INTERCEPTOR WITH INVERT OUTSIDE OF BASIN

A-82.34 (7) COMMERCIAL LAUNDRIES

TRENCH TYPE LAUNDRY INTERCEPTOR

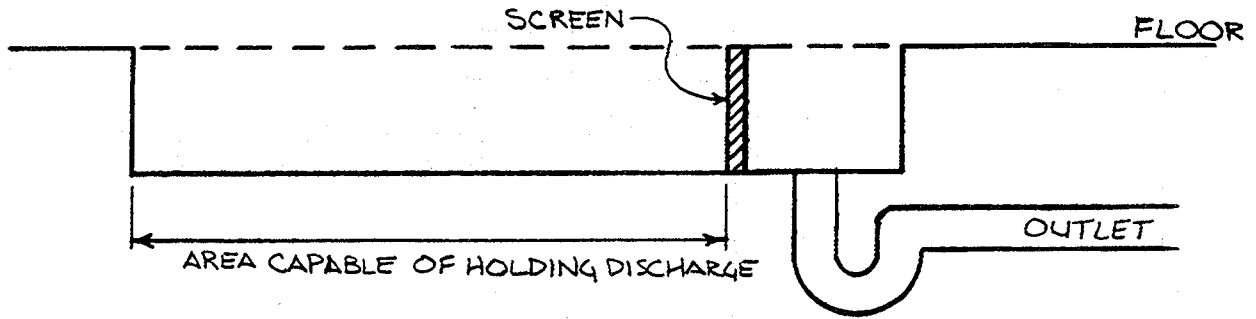

IN-LINE LAUNDRY INTERCEPTOR

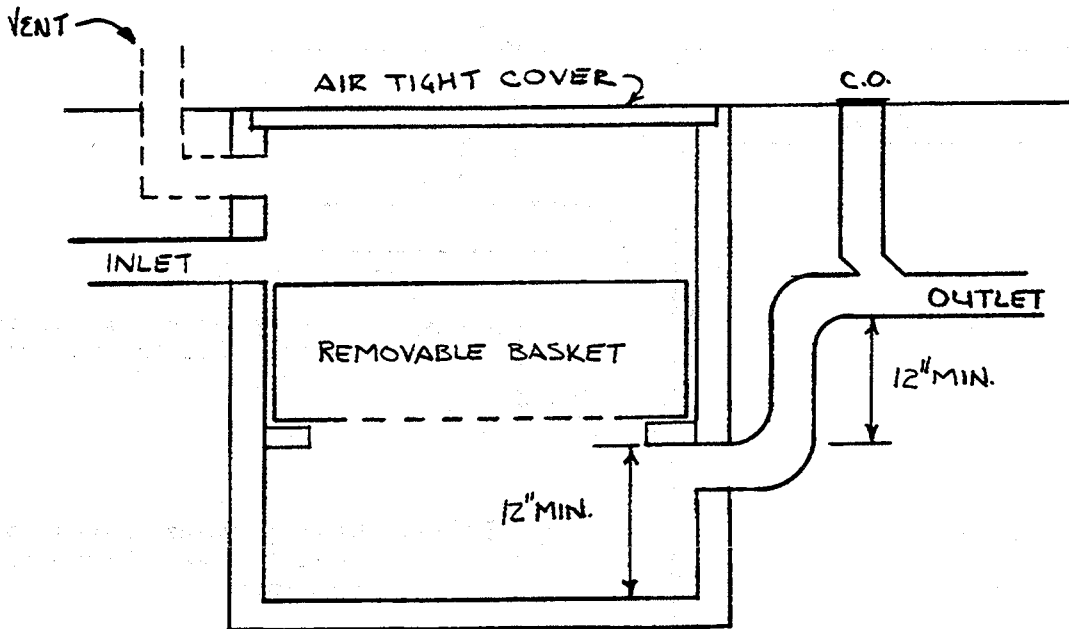

A-82.34 (8) OIL AND FLAMMABLE LIQUIDS

OIL INTERCEPTOR

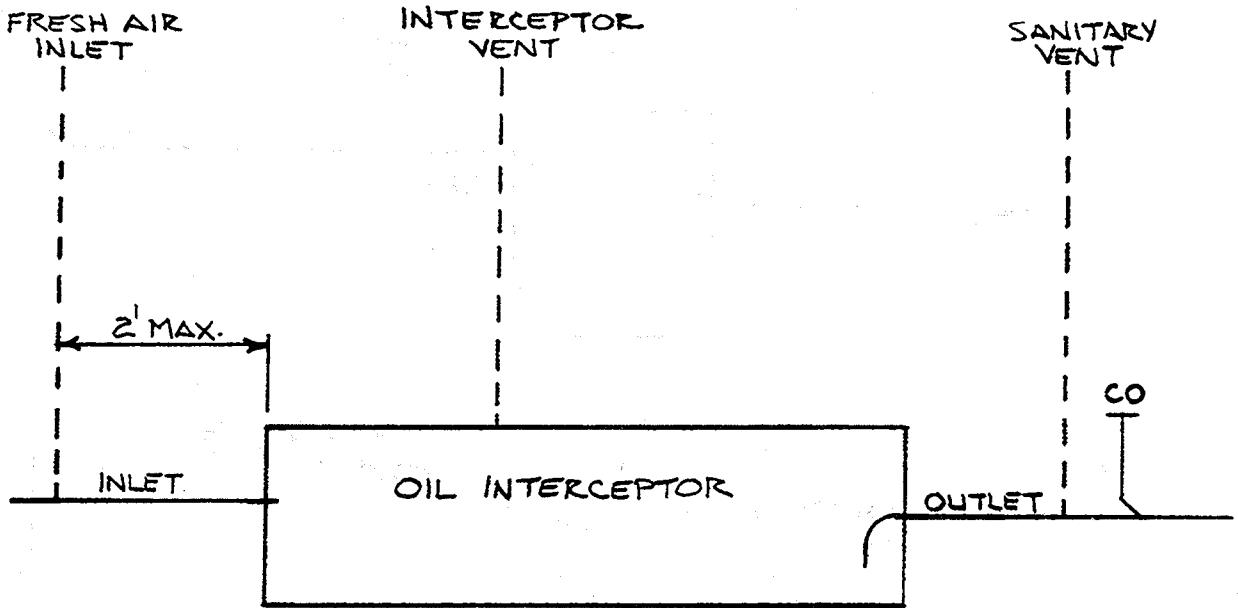

A-82.34 (13) PLASTER AND HEAVY SOLIDS TRAP TYPE INTERCEPTORS

PLASTER AND HEAVY SOLIDS TRAP TYPE INTERCEPTORS

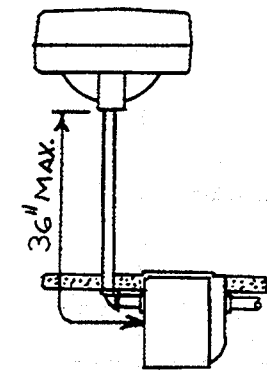

FLUSH WITH FLOOR INSTALLATION

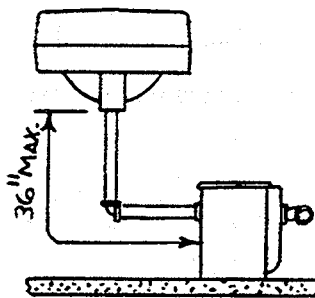

ON THE FLOOR INSTALLATION

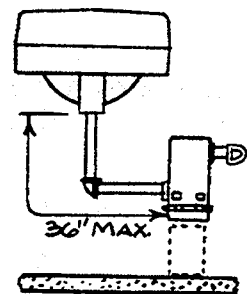

SUSPENDED TYPE INSTALLATION

A-82.34 (14) CHEMICAL DILUTION AND NEUTRALIZING BASINS.

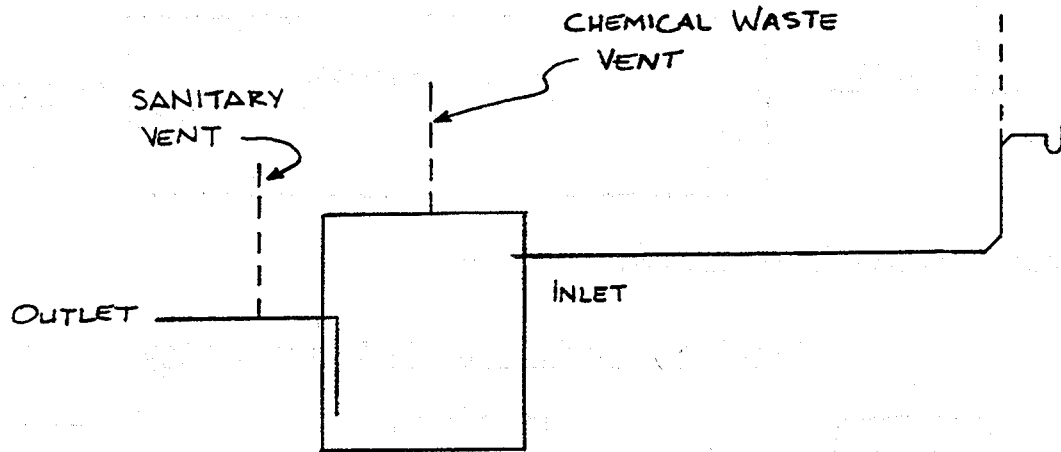
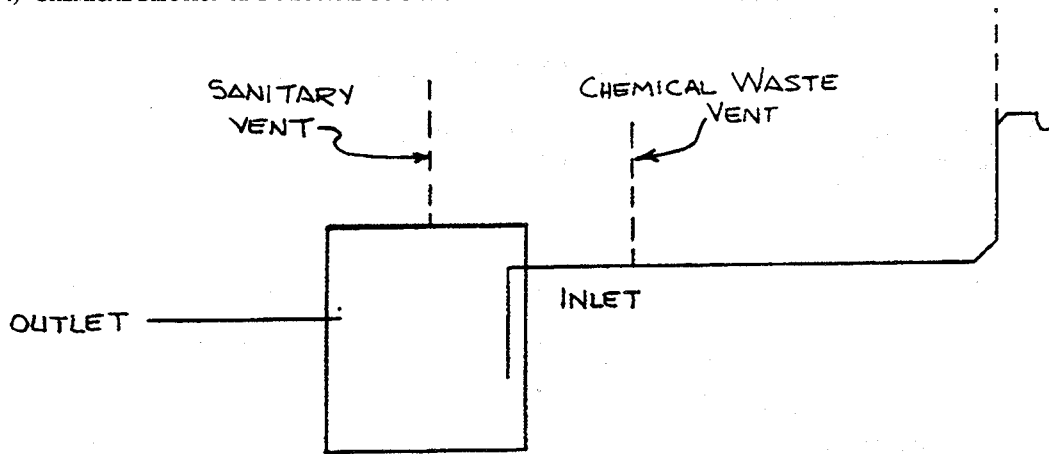

A-82.35 (3) CLEANOUTS SERVING HORIZONTAL DRAINS WITHIN OR UNDER A BUILDING.

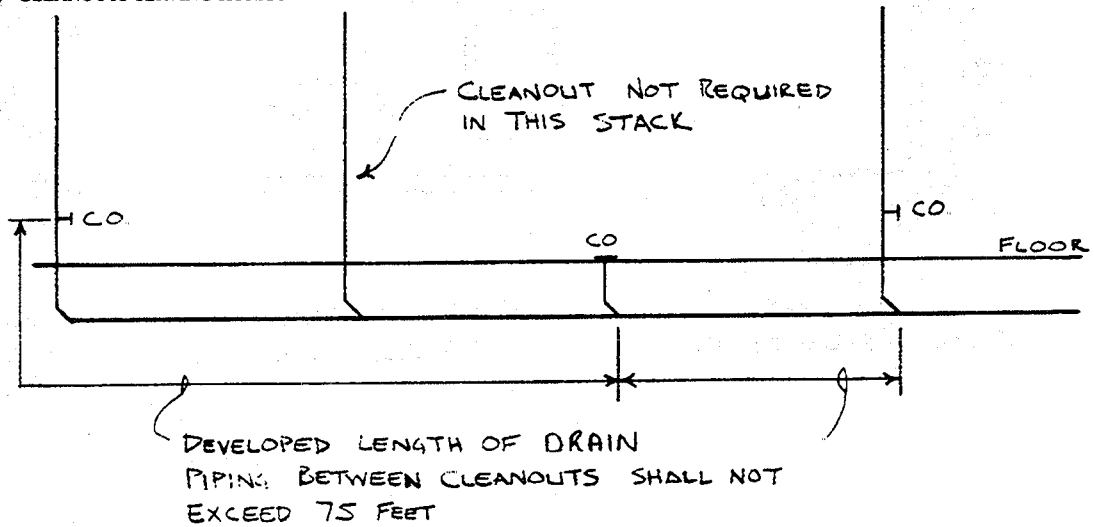

A-82.35 (3) CLEANOUTS SERVING HORIZONTAL DRAINS

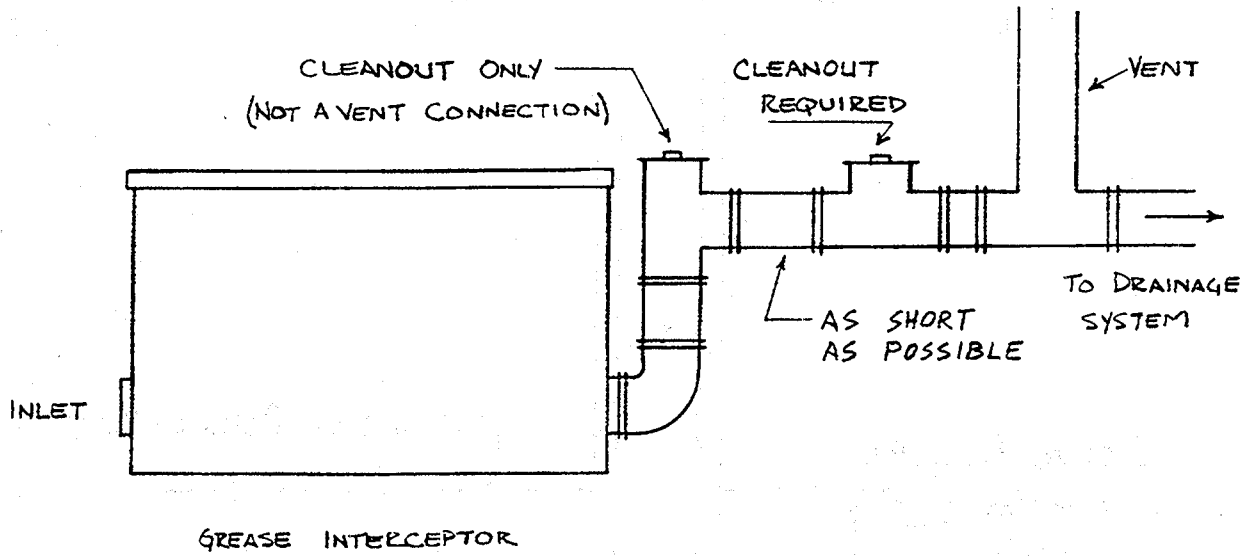
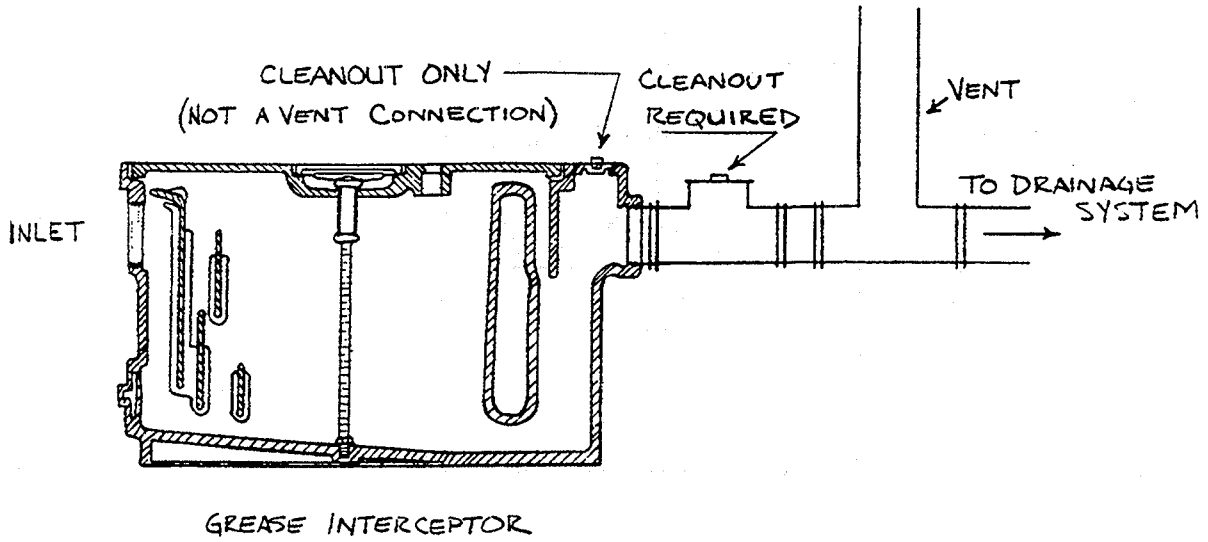

A-82.35 (5) (a) CLEANOUT EXTENSION TO GRADE.

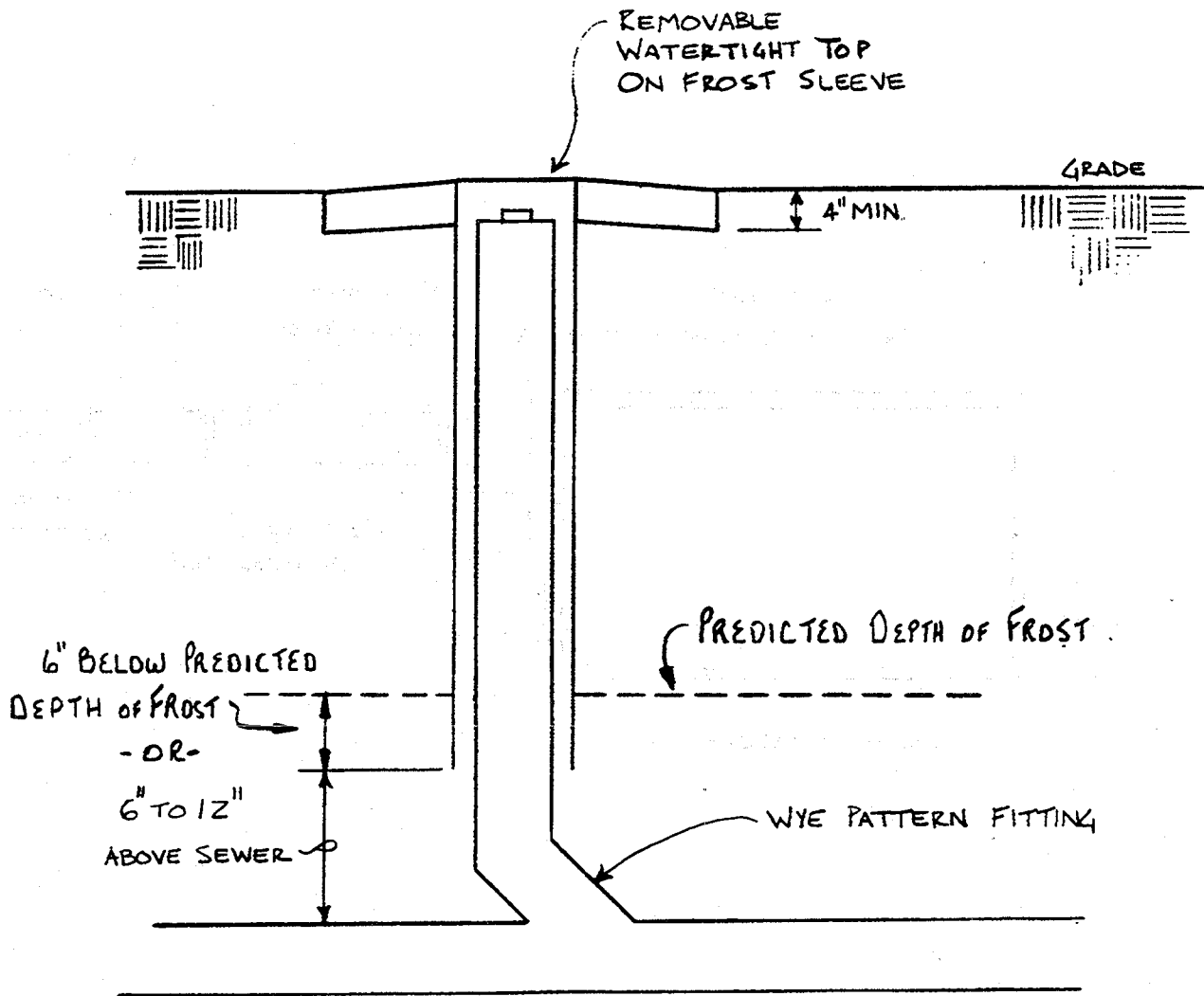
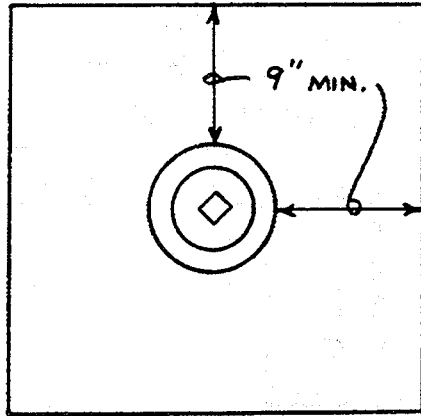



A-82.35 (8) MANHOLES.

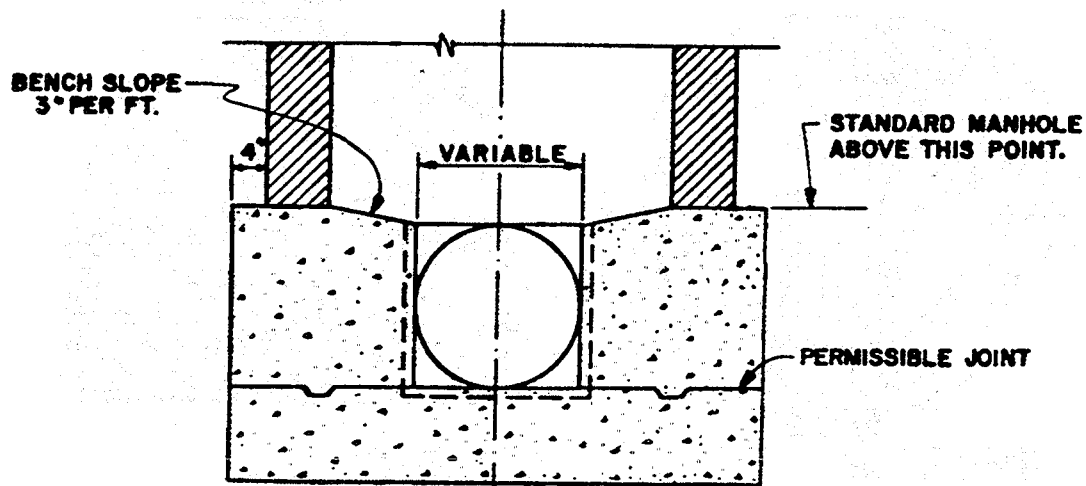
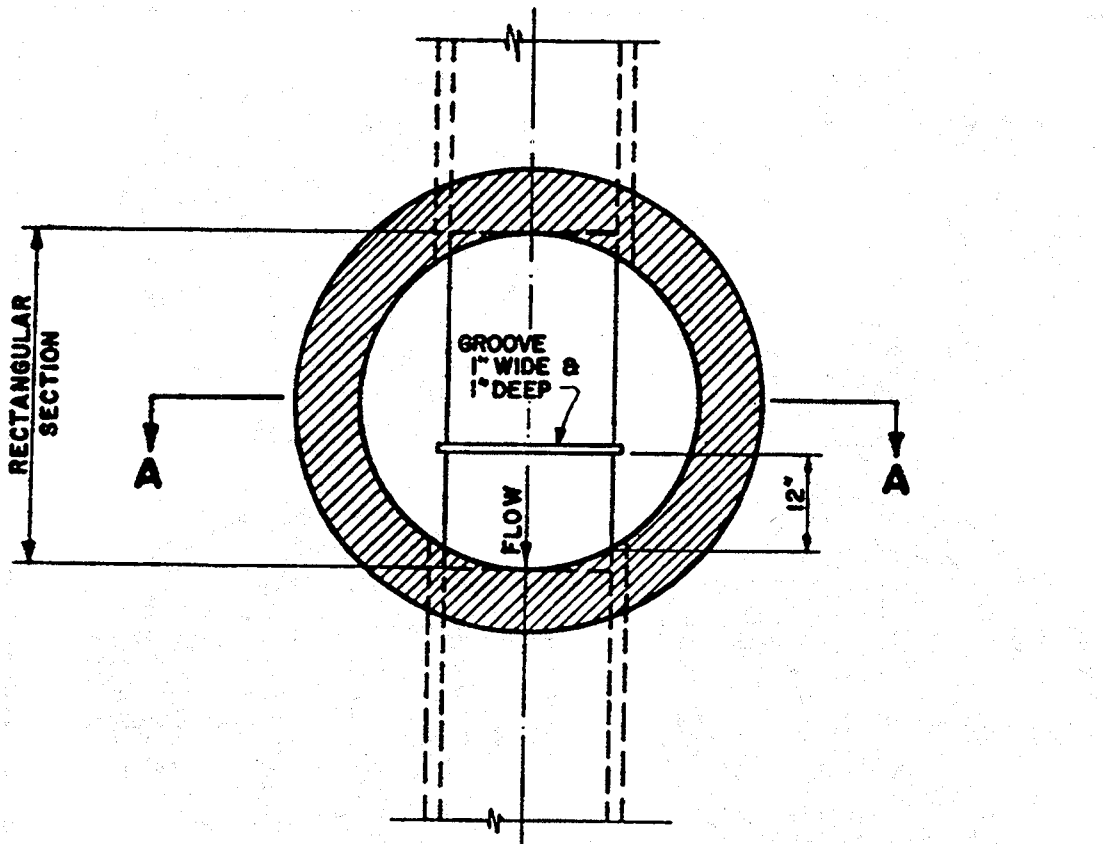

SECTION A-A

DETAIL OF SAMPLING MANHOLE

A-82.35 (8) MANHOLES

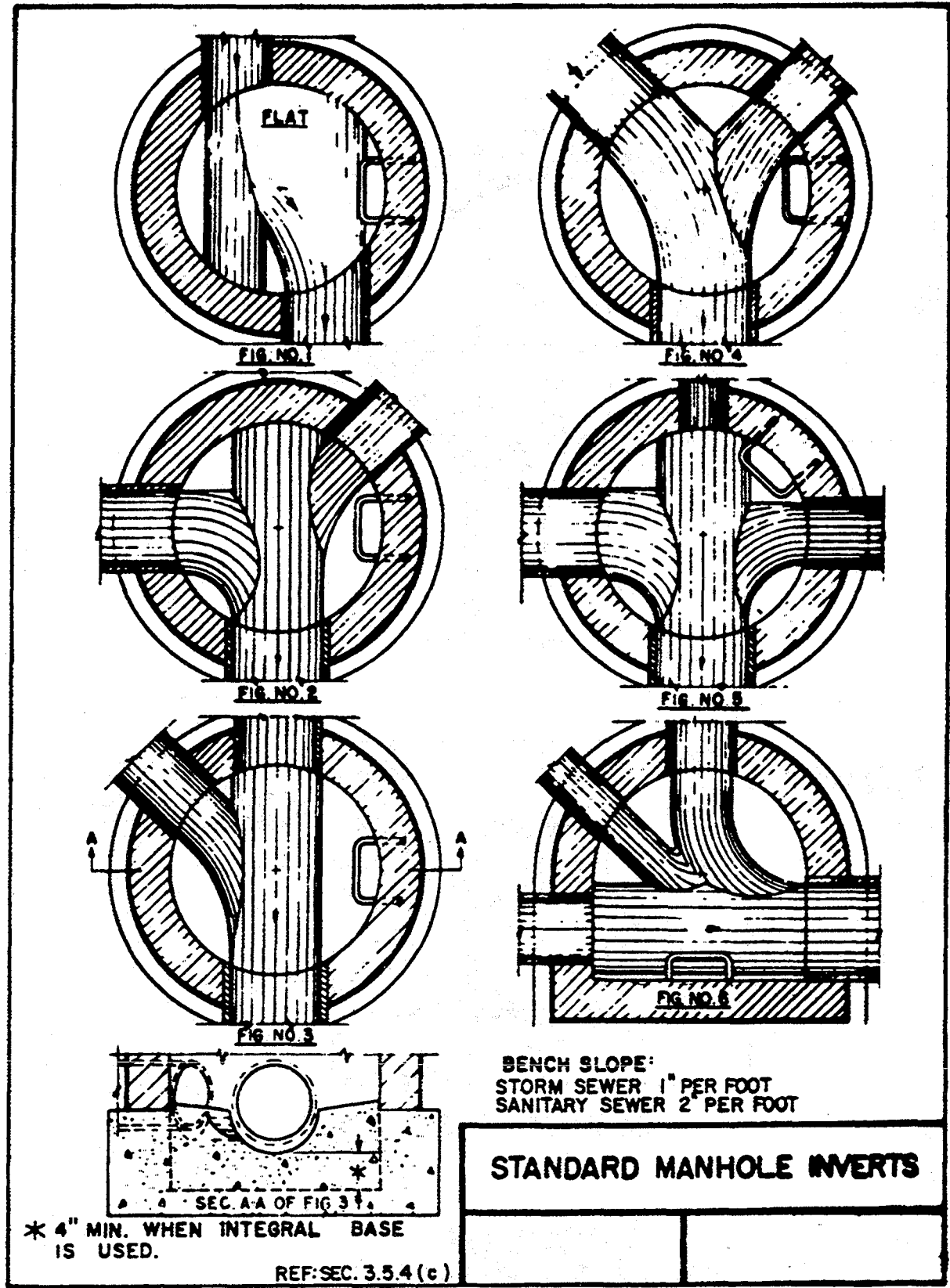

A-82.35 (8) MANHOLES.

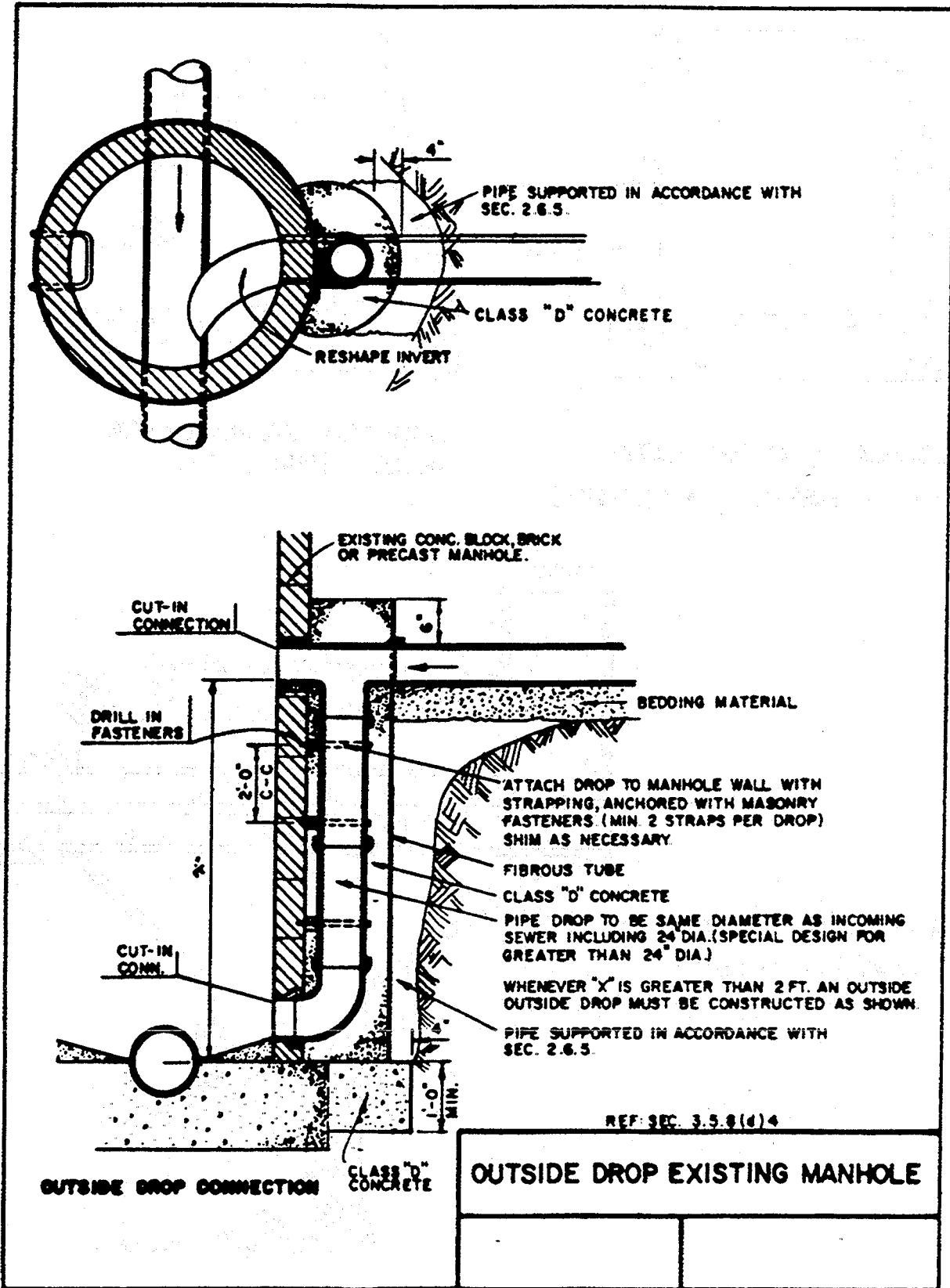

A-82.36 (17) AREA DRAIN INLETS.

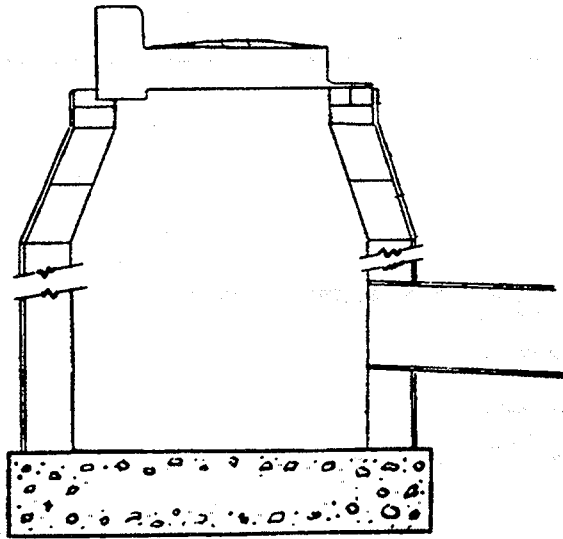

**STANDARD STORM WATER  
CATCH BASIN (MASONRY)**

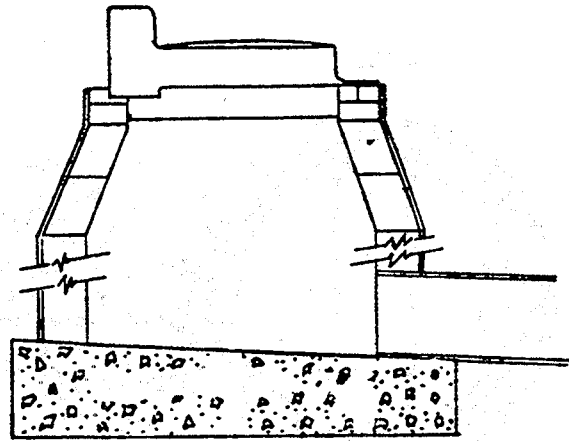

**STANDARD STORM WATER  
INLET (MASONRY)**

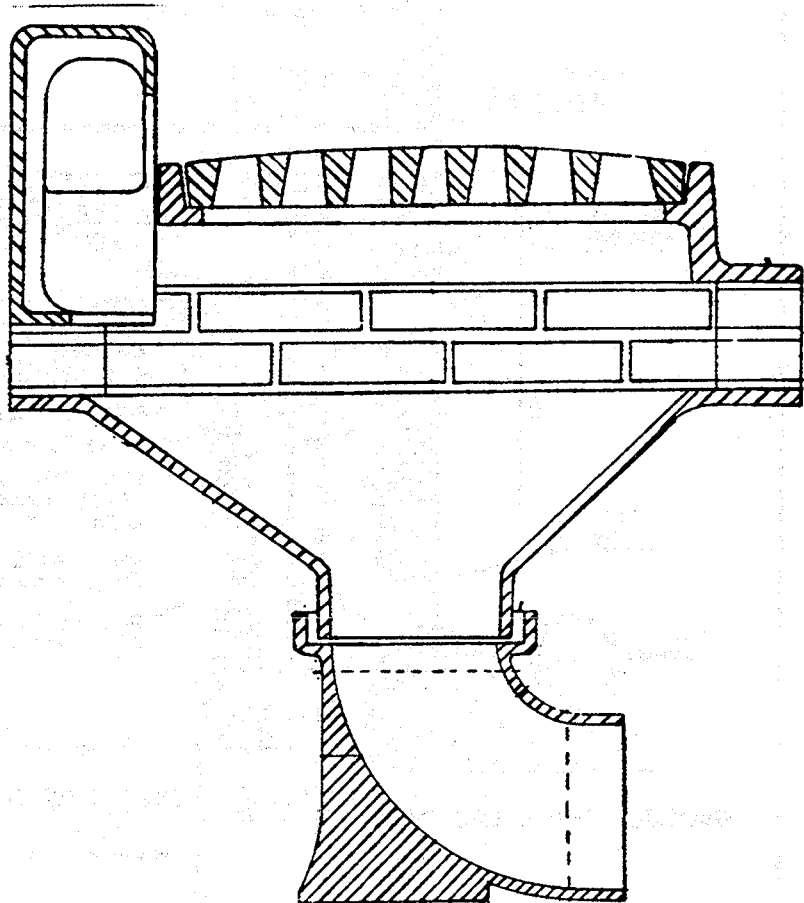

**CAST IRON STORM  
WATER INLET**

A-82.40 (4) CONTROL VALVES.

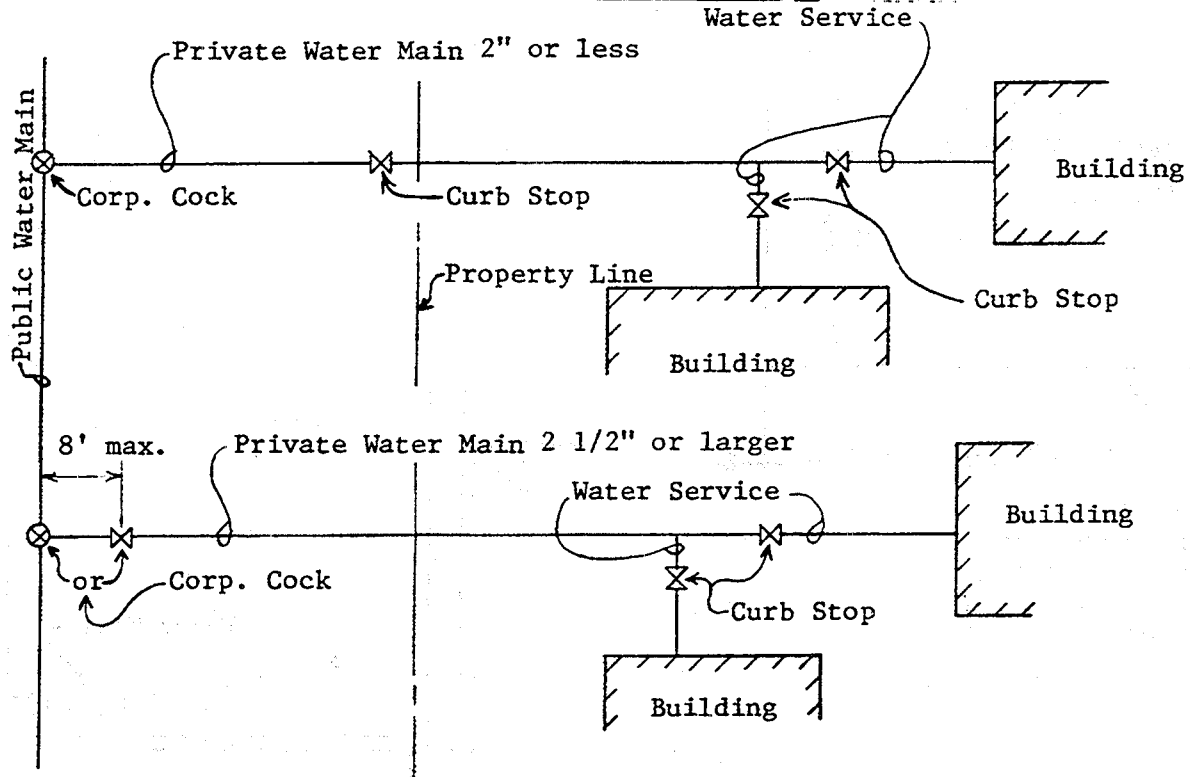

A-82.40 (4) (b) WATER SERVICES.

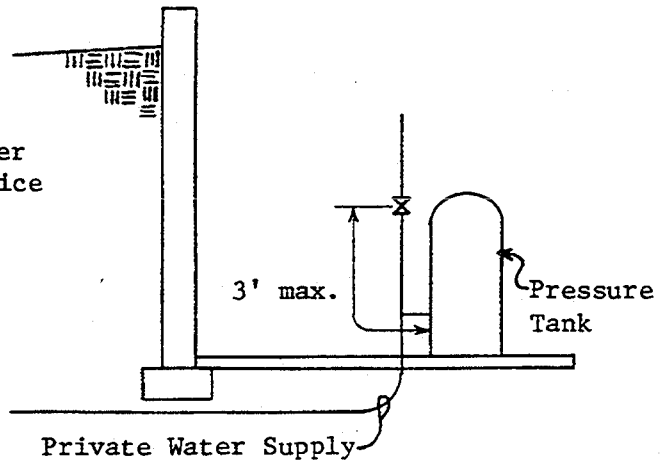
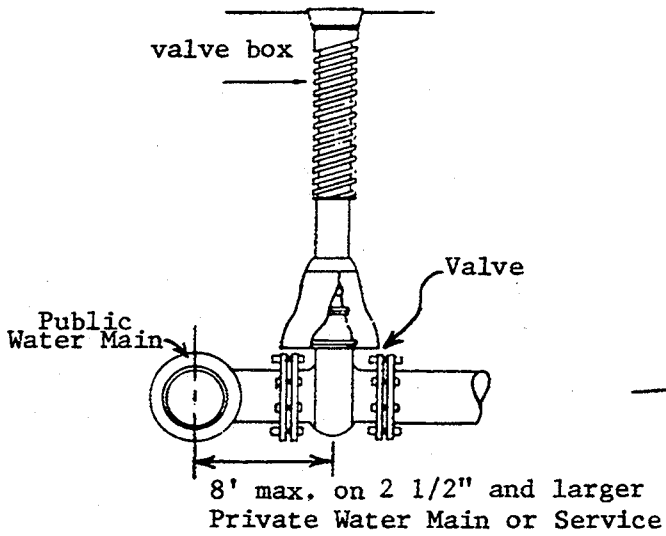
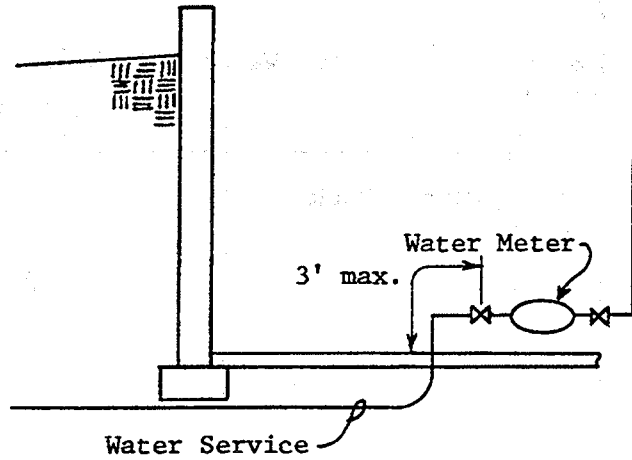
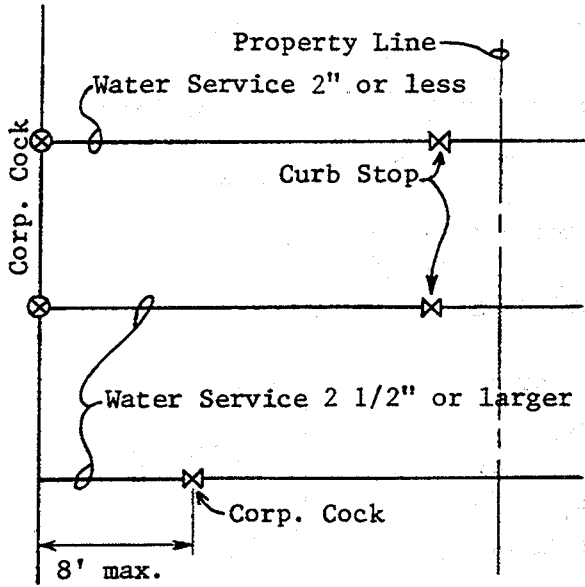

**A-82.40 (5) STORAGE TANK AND PIPING INSULATION.** The following is a reprint of section ILHR 63.63.

**ILHR 63.33 Insulation. (1) STORAGE TANKS.** Heat loss from unfired hot water storage tanks shall be limited to 15 Btu of 25 Btu per hour square foot of external pipe insulation surface area. The design ambient temperature shall be no higher than 65° F.

**(2) PIPING.** (a) Except as provided in par. (b), piping heat loss for recirculation systems shall be limited to a maximum of 25 Btu per hour square foot of external pipe insulation surface for aboveground piping and a maximum of 35 Btu per hour per square foot of external pipe insulation for under ground piping. Maximum heat loss shall be determined at a  $\Delta T$  equal to the maximum water temperature minus a design ambient temperature no higher than 65° F.

(b) Conformance to the minimum pipe insulation requirements specified in Table 63.22 shall be deemed as complying with the requirements of this subsection.

**A-82.40 (7) (a) METHODOLOGY**

Where equipment such as an instantaneous or tankless water heater, water treatment device, water meter, and backflow preventer is provided in the design, the friction loss in such equipment, corresponding to the GPM demand, should be determined from the manufacturer or other reliable source.

Where a direct fired pressurized tank type water heater is provided in the design, the friction loss for such equipment can be assumed as part of the pressure losses due to flow through piping, fittings, valves and other plumbing appurtenances when the developed length of piping is multiplied by 1.5.

The pressure losses due to flow friction through displacement type cold-water meters may be calculated from Graph A-82.40 (7)-1.

Graph A-82.40 (7) - 1  
PRESSURE LOSS IN COLD-WATER METERS, DISPLACEMENT TYPE

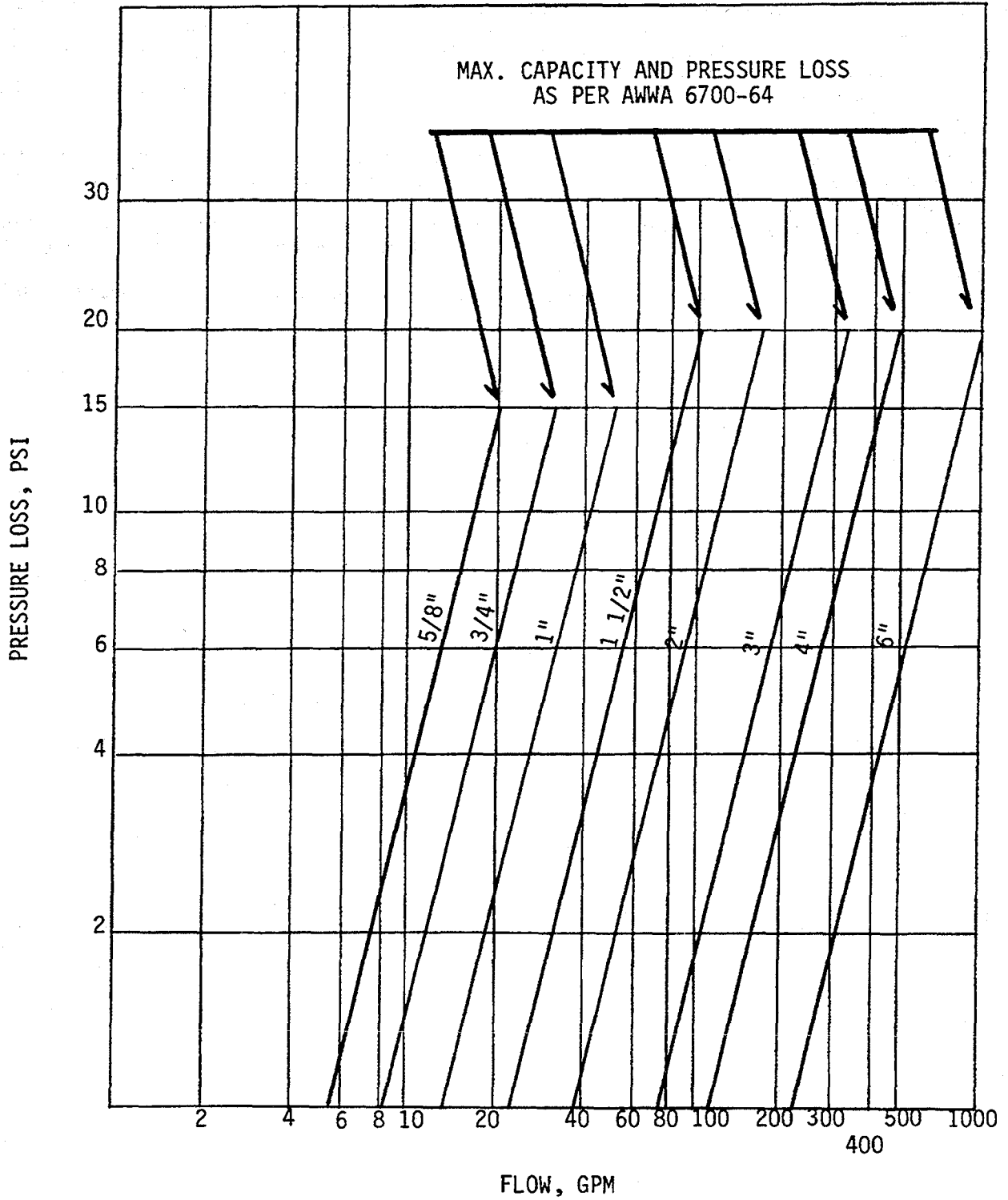



A-82.40 (7) (b) PRIVATE WATER MAINS AND WATER SERVICES.

Graphs A-82.40 (7)-2 to A-82.40 (7)-6 may be used to size private water mains and water services.

Graph A-82.40 (7)-2

Pressure losses due to flow friction

Material: Copper Tube-Type K, ASTM B88

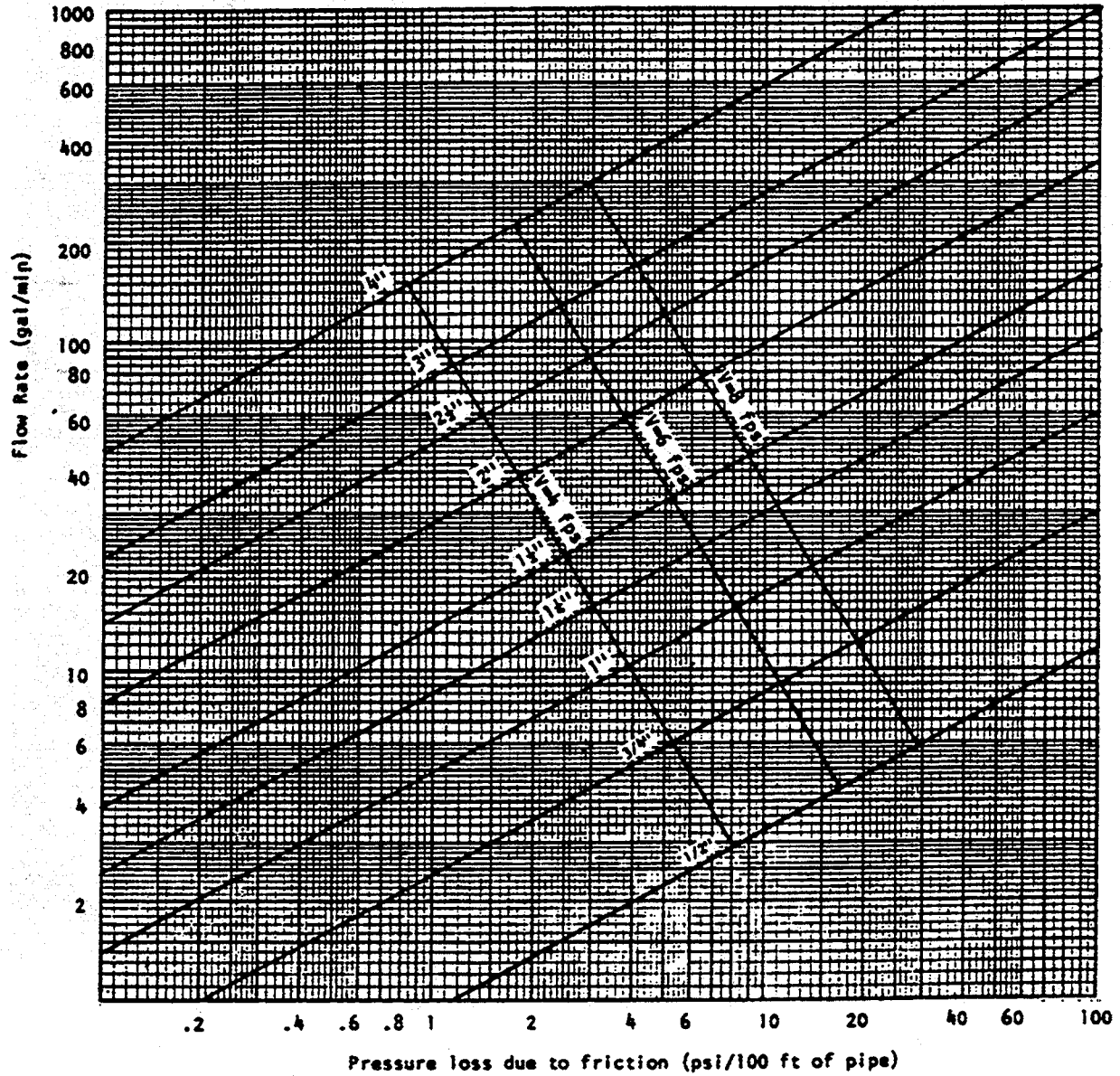

Graph A-82.40 (7)-3  
Pressure losses due to flow friction  
Material: Copper Tube-Type L, ASTM B88

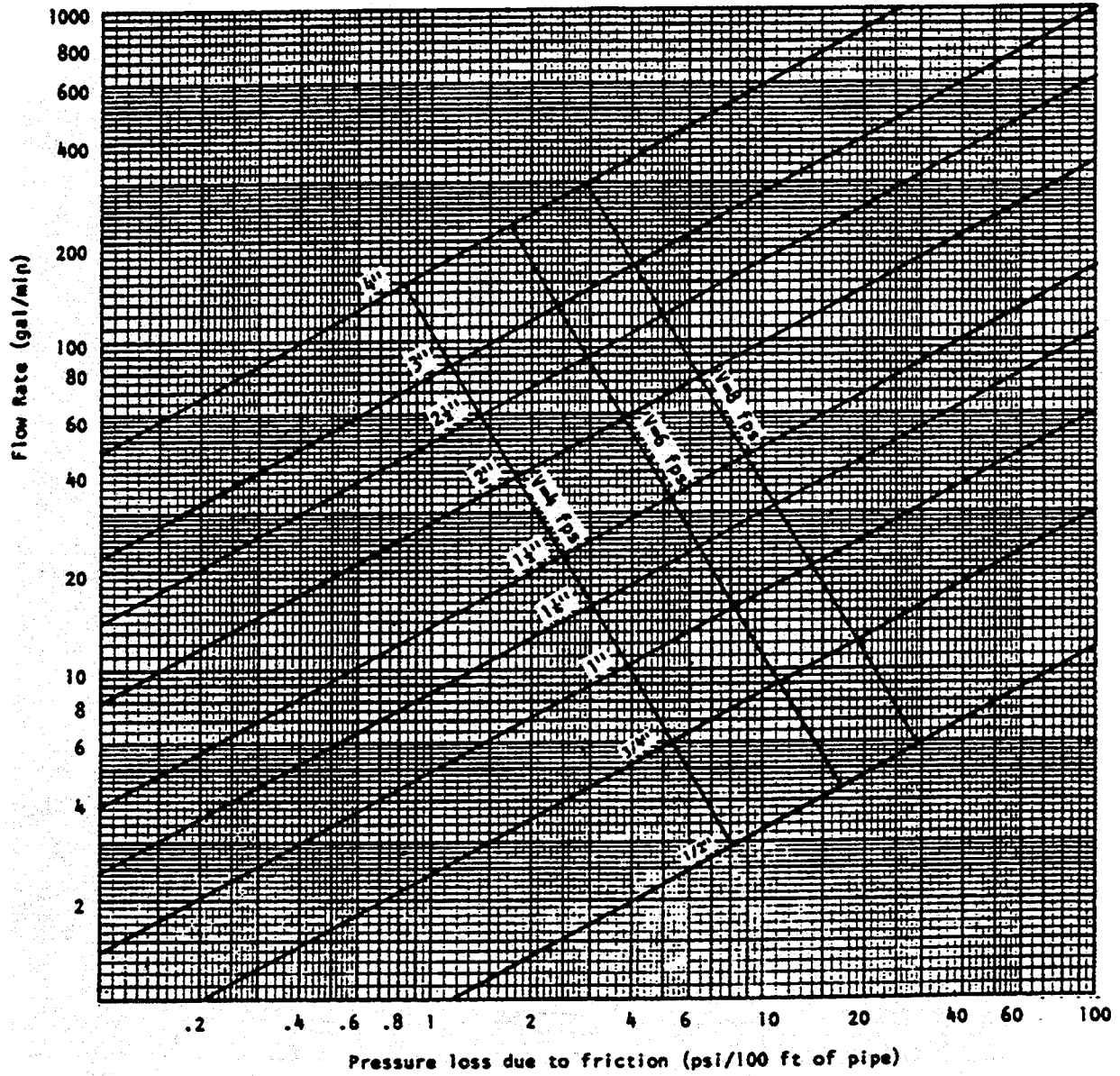

**Graph A-82.40 (7)-4**

Pressure losses due to flow friction

Material: Galvanized Steel Pipe-Schedule 40, ASTM A53, ASTM A120;

ABS Pipe-Schedule 40; ASTM D1527; or

CPVC Pipe-Schedule 40; ASTM F441; or

PE Pipe-Schedule 40; ASTM D2104; ASTM D2447; or

PVC Pipe-Schedule 40; ASTM D1785; ASTM D2672

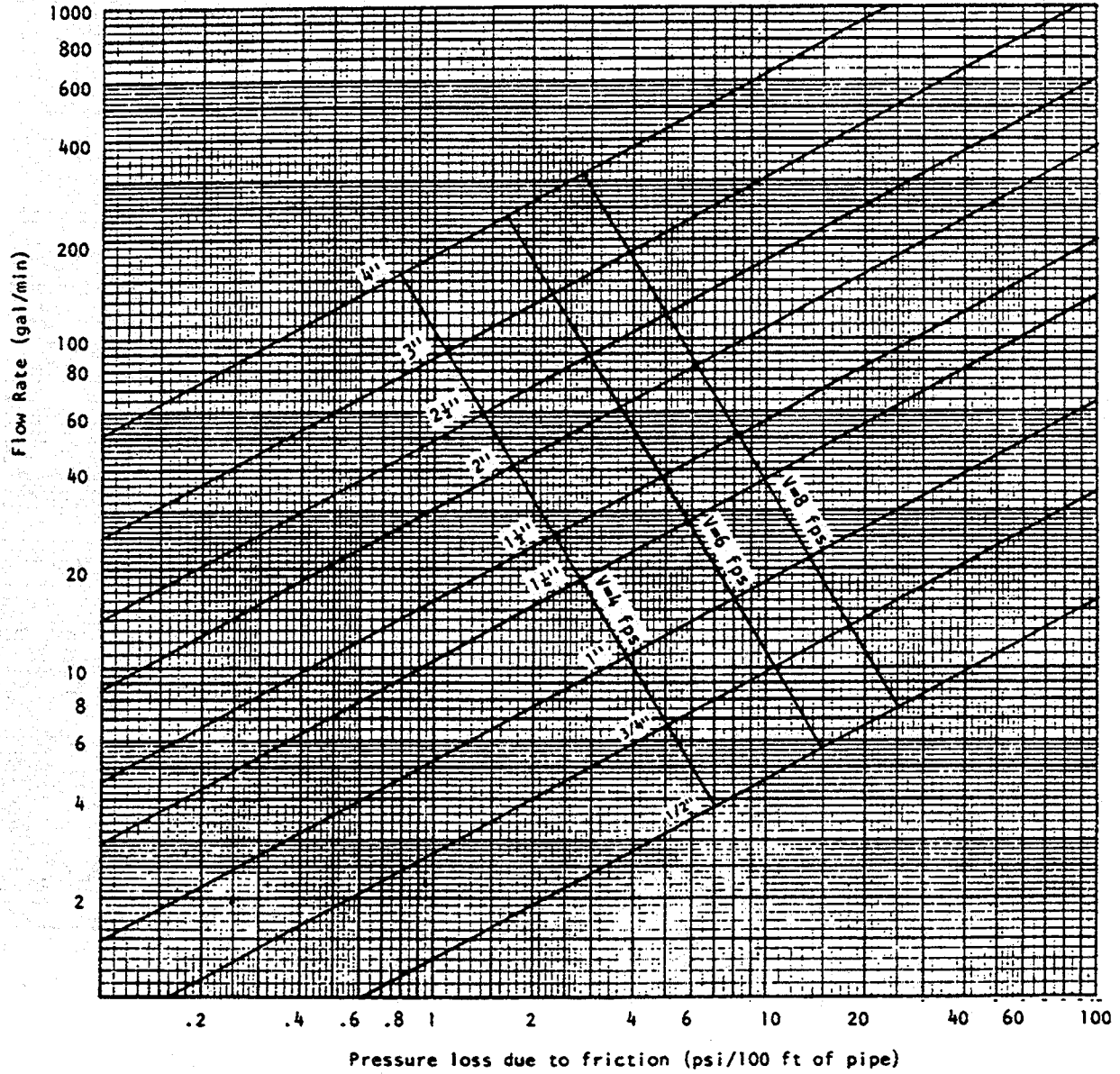

**Graph A-82.40 (7)-5**  
Pressure losses due to flow friction  
Material: Polybutylene Tubing, ASTM D3309; or  
CPVC Tubing; ASTM D2846

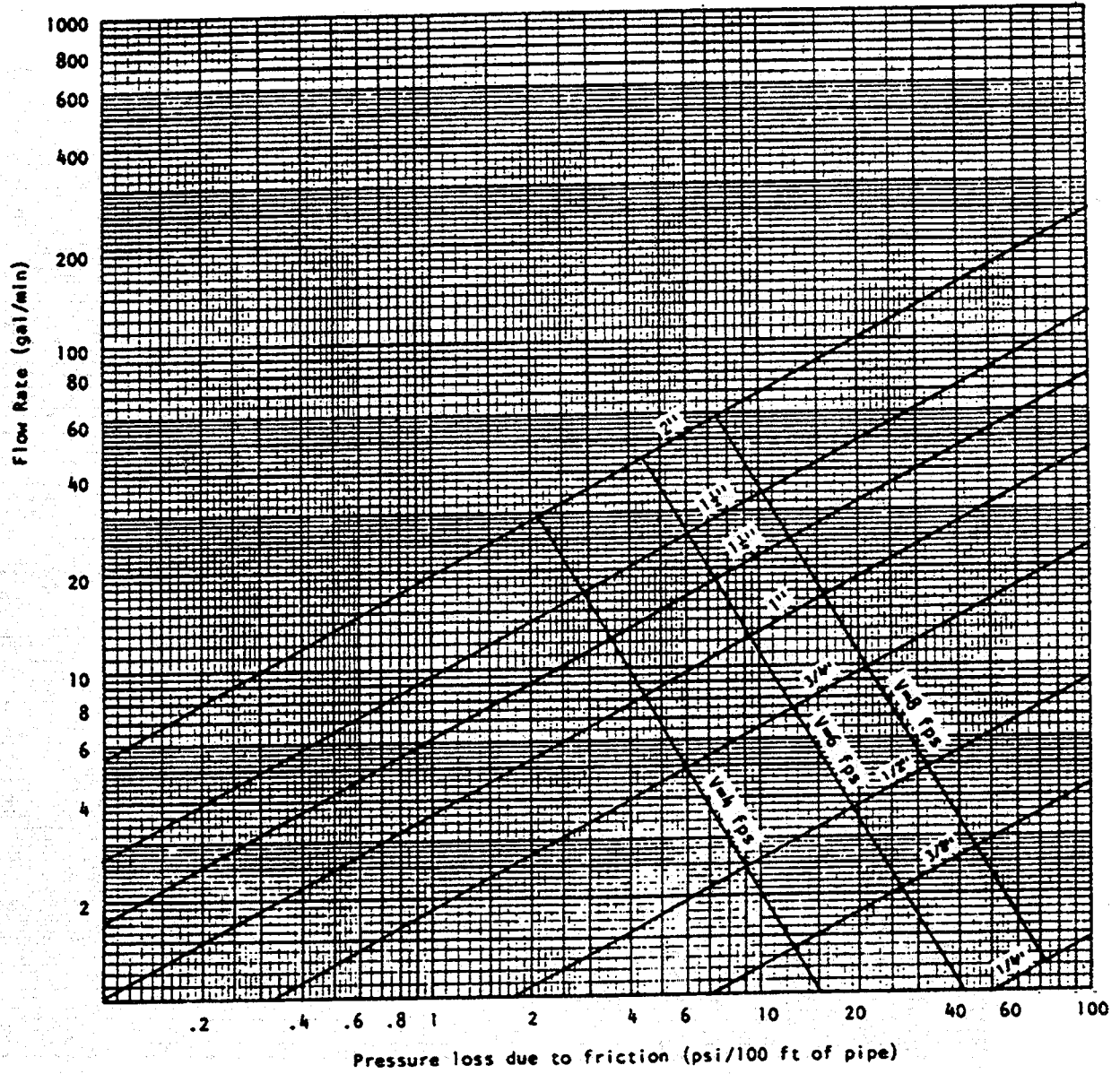

**Graph A-82.40 (7)-6**  
 Pressure losses due to flow friction  
 Material: Crosslinked Polyethylene (PEX) Tubing, ASTM F876

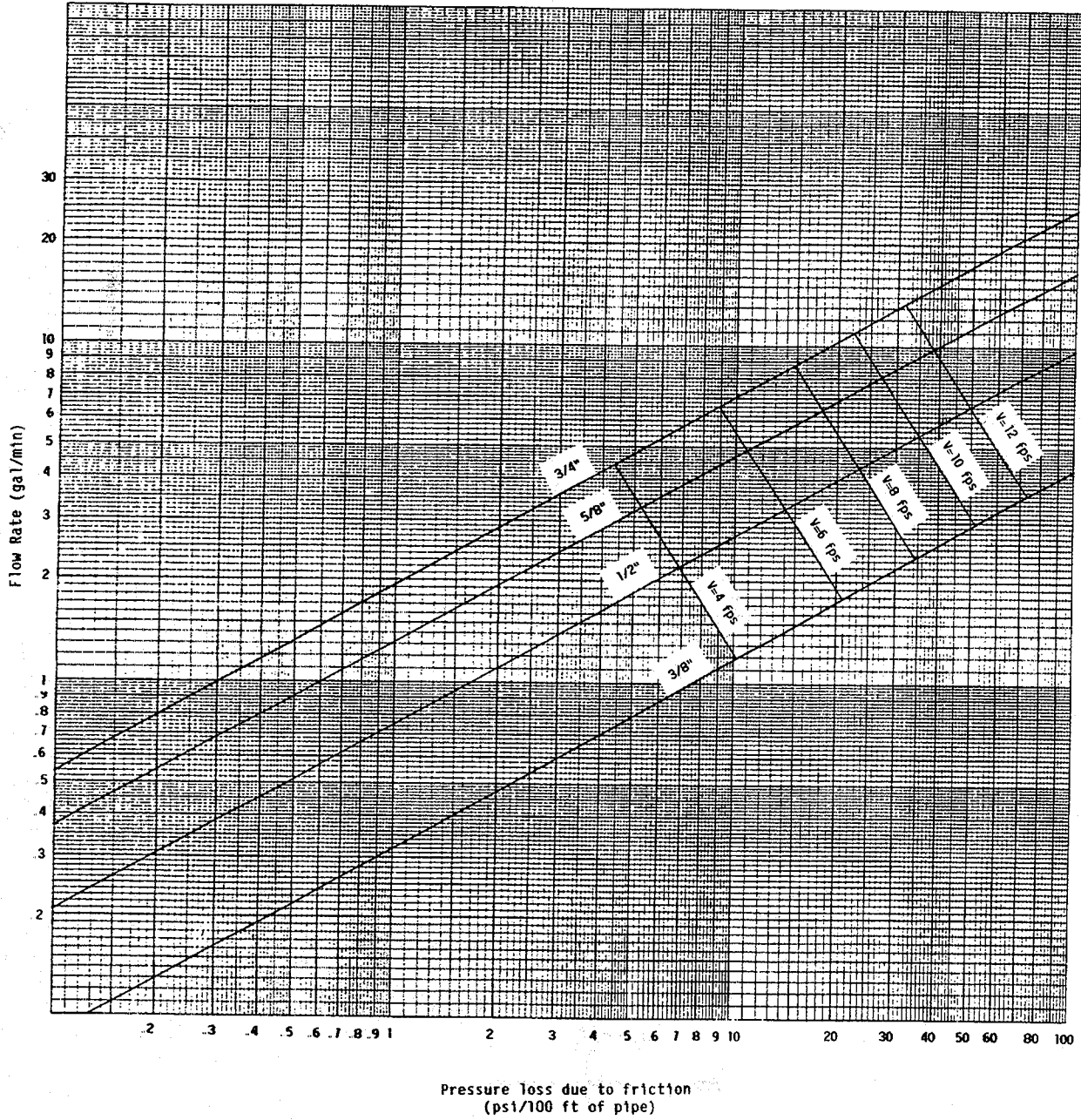

A82.41 (4) (g) 2. TEST OUTLET

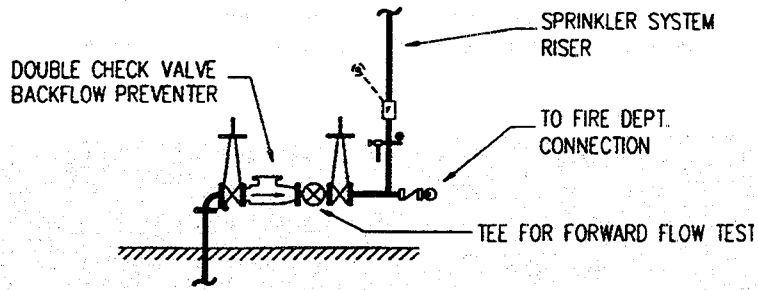

SINGLE WET SYSTEM ARRANGEMENT

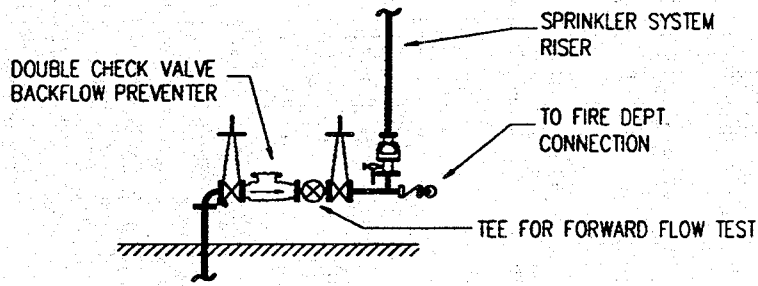

SINGLE DRY SYSTEM ARRANGEMENT

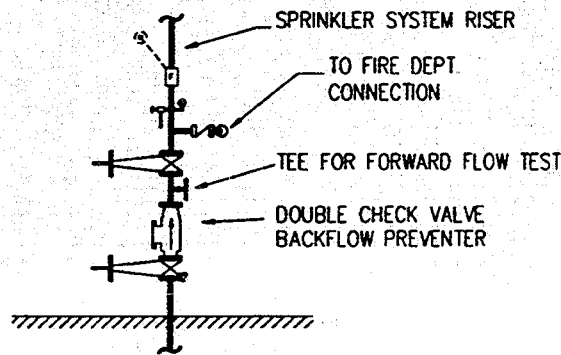

SINGLE WET SYSTEM ARRANGEMENT

A-82.41 (5) (a) AIR GAP

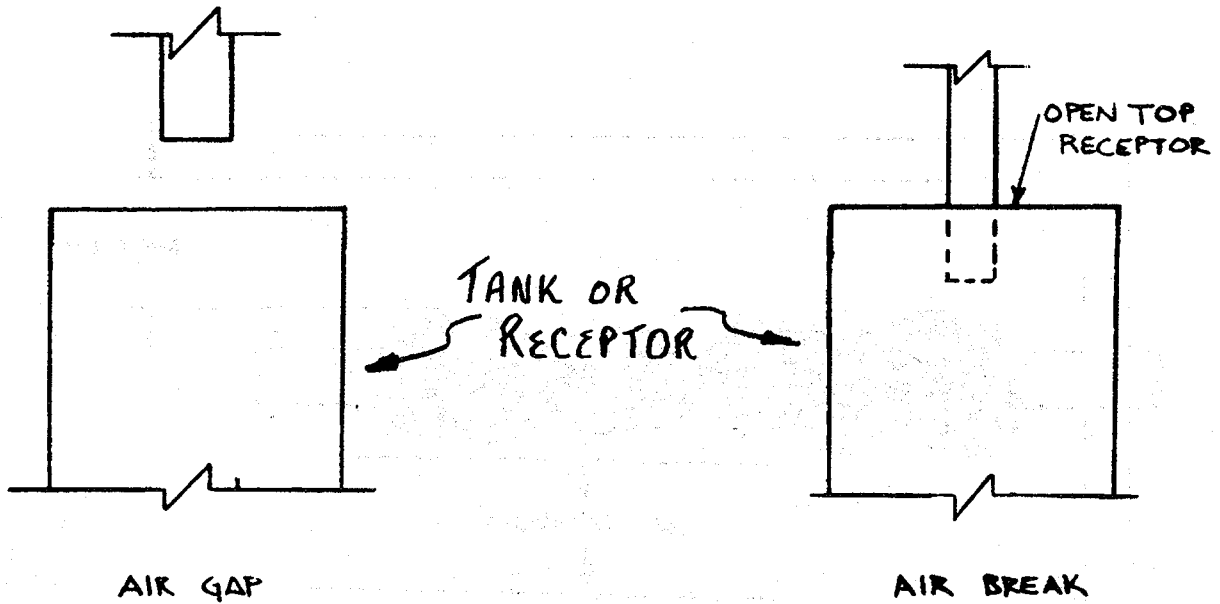

ANSI STANDARD A112.1.2 DESCRIBES OTHER ACCEPTABLE TYPES OF AIR GAPS.

A-82.41 (5) (f) CROSS CONNECTION CONTROL DEVICE INSTALLATION.

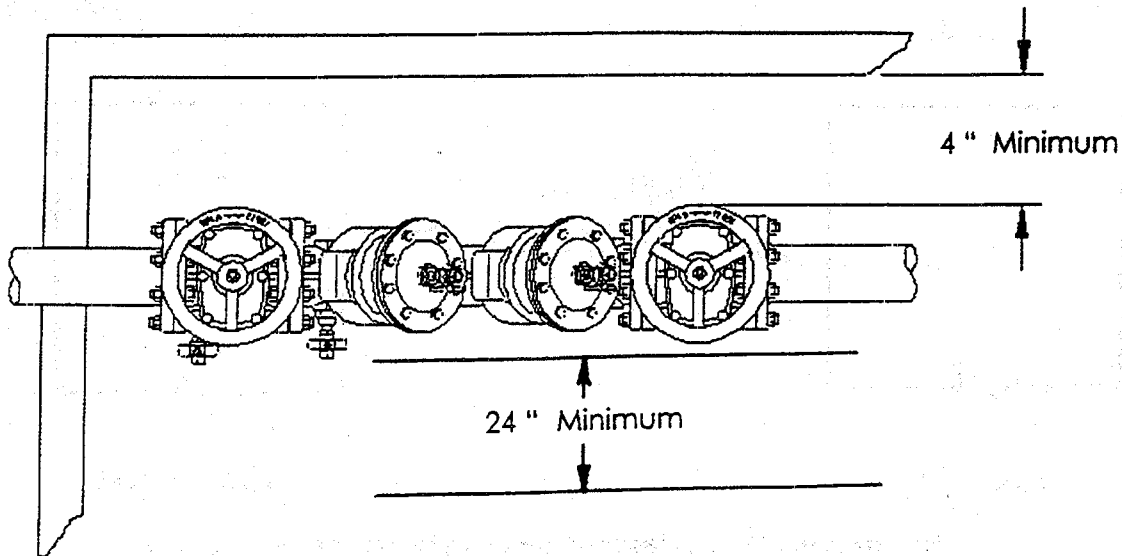

NOTE: ASSEMBLIES SHALL BE INSTALLED IN ACCORDANCE WITH THE MANUFACTURER'S WRITTEN INSTALLATION SPECIFICATIONS OR WITHIN THE DIMENSIONS SHOWN.

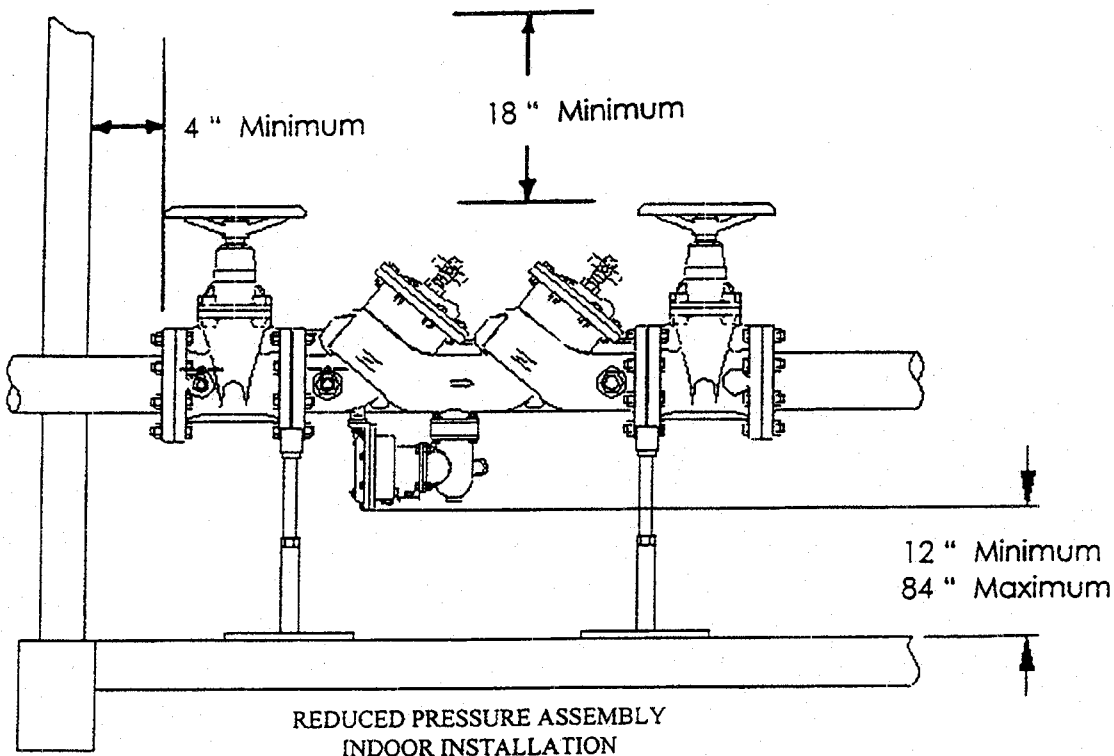



A-82.41 (5) (f) CROSS CONNECTION CONTROL DEVICE INSTALLATION

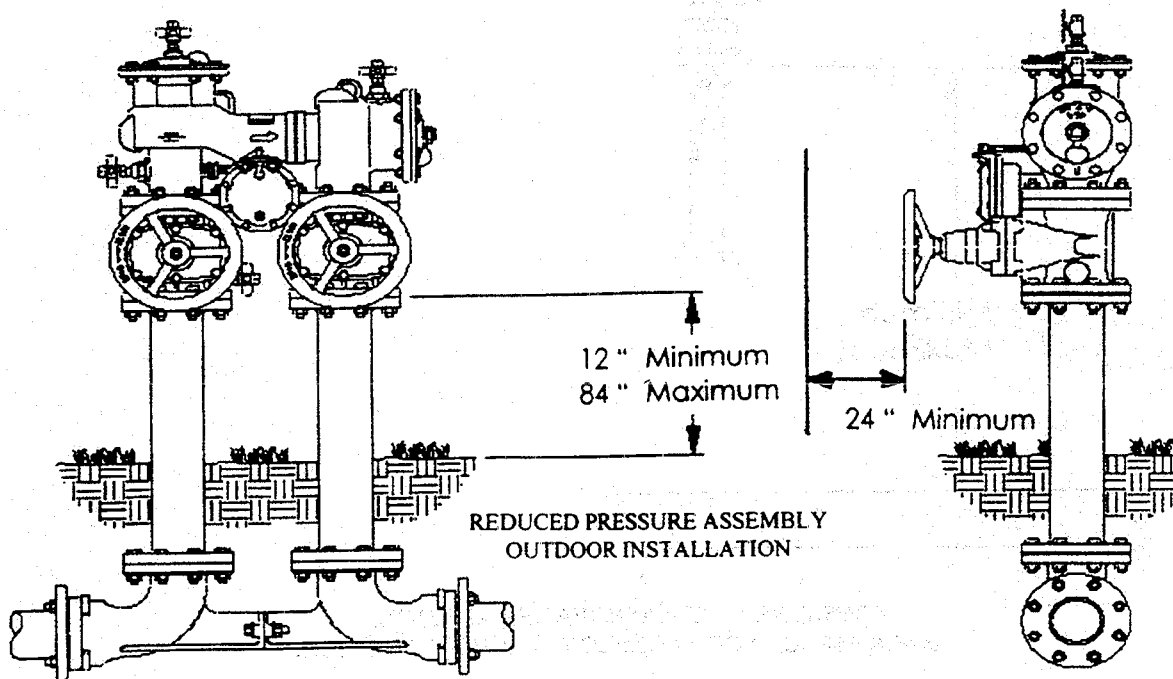
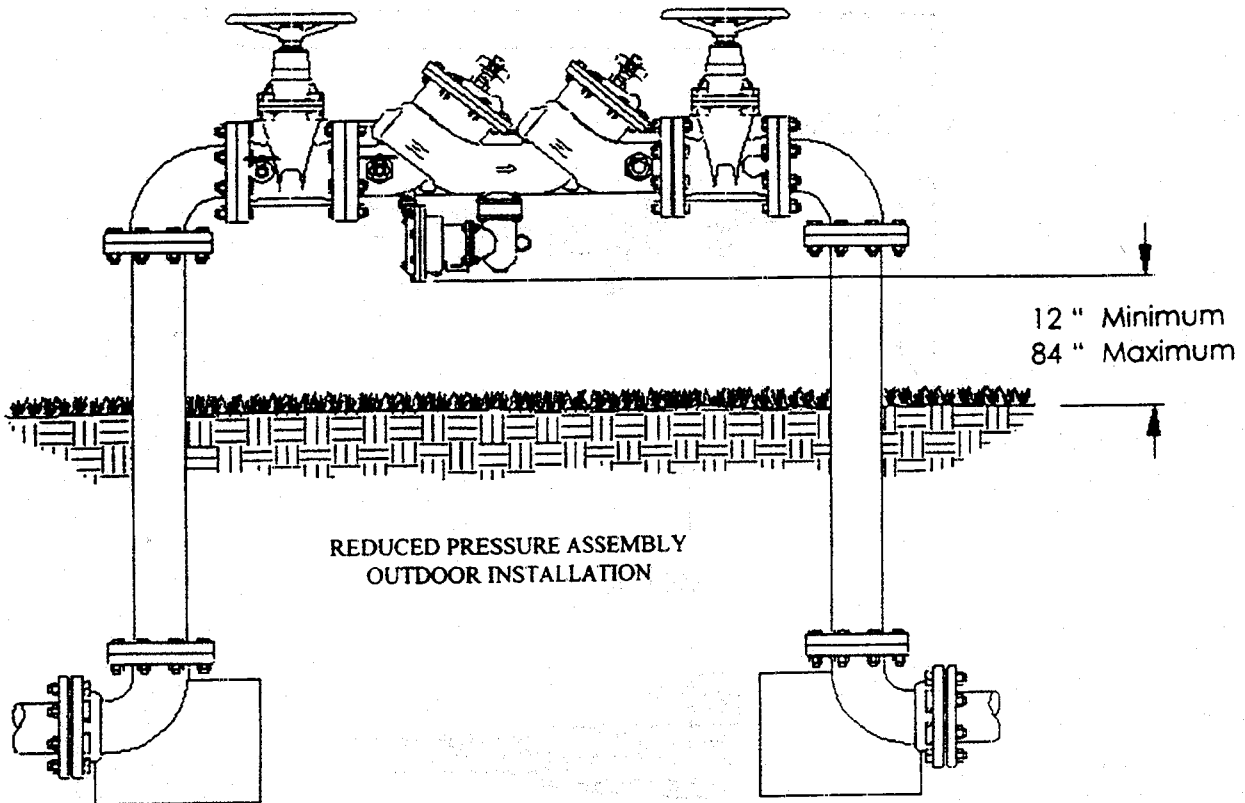

A-82.41 (5) (f) CROSS CONNECTION CONTROL DEVICE INSTALLATION

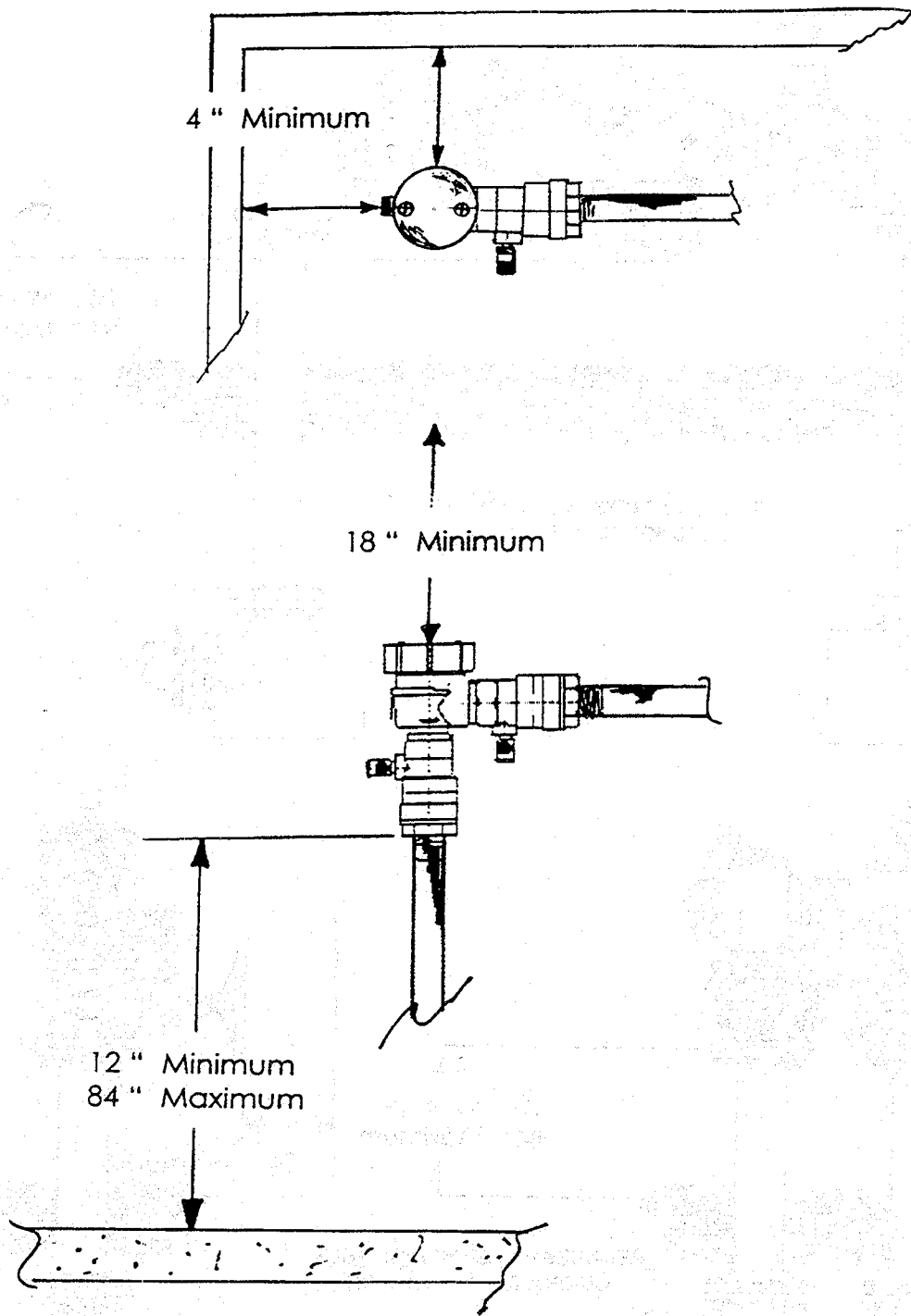

PRESSURE VACUUM BREAKER ASSEMBLY  
BACK SIPHONAGE BACKFLOW VACUUM BREAKER

A-82.41 (5) (f) CROSS CONNECTION CONTROL DEVICE INSTALLATION.

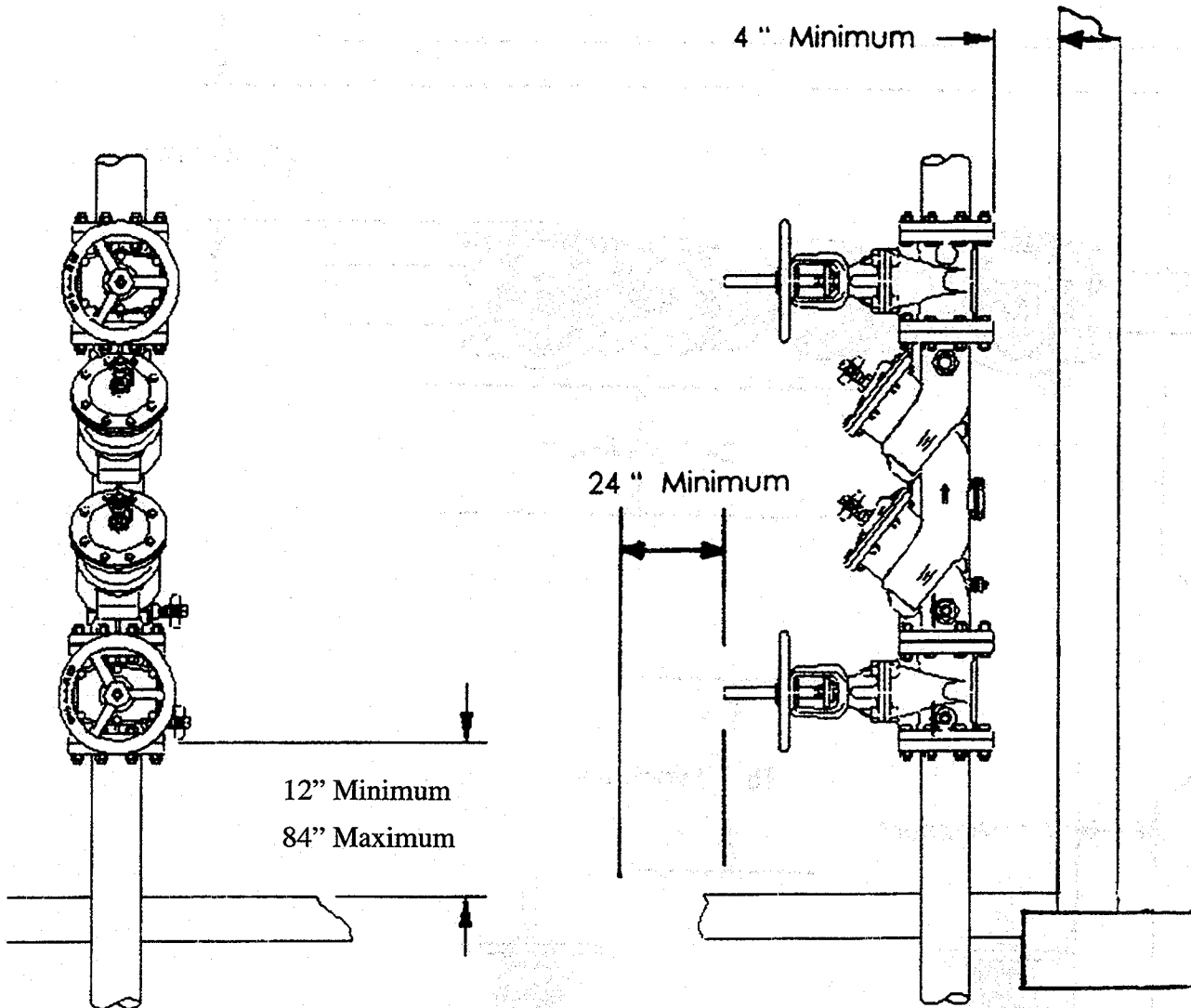

DOUBLE CHECK ASSEMBLY  
INDOOR VERTICAL INSTALLATION

A-82.41 (5) (f) CROSS CONNECTION CONTROL DEVICE INSTALLATION.

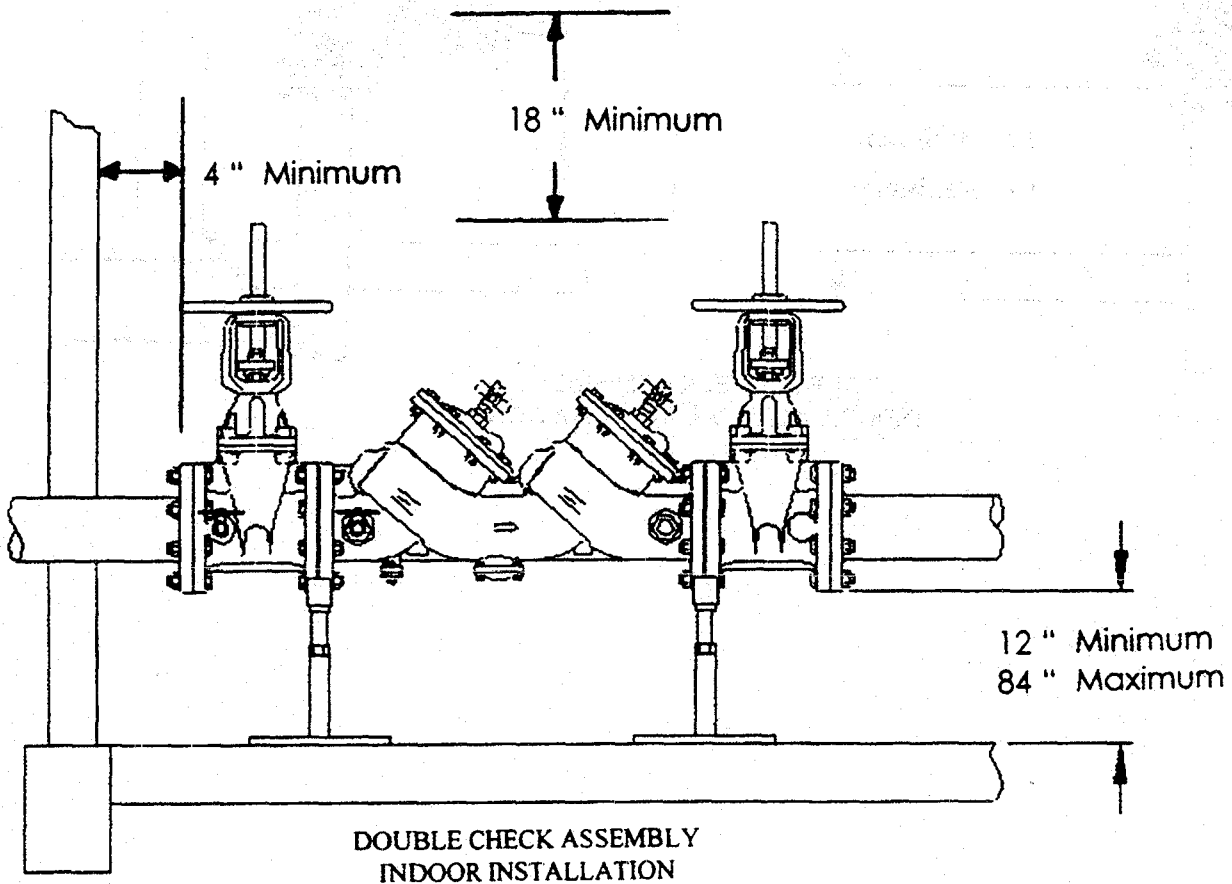
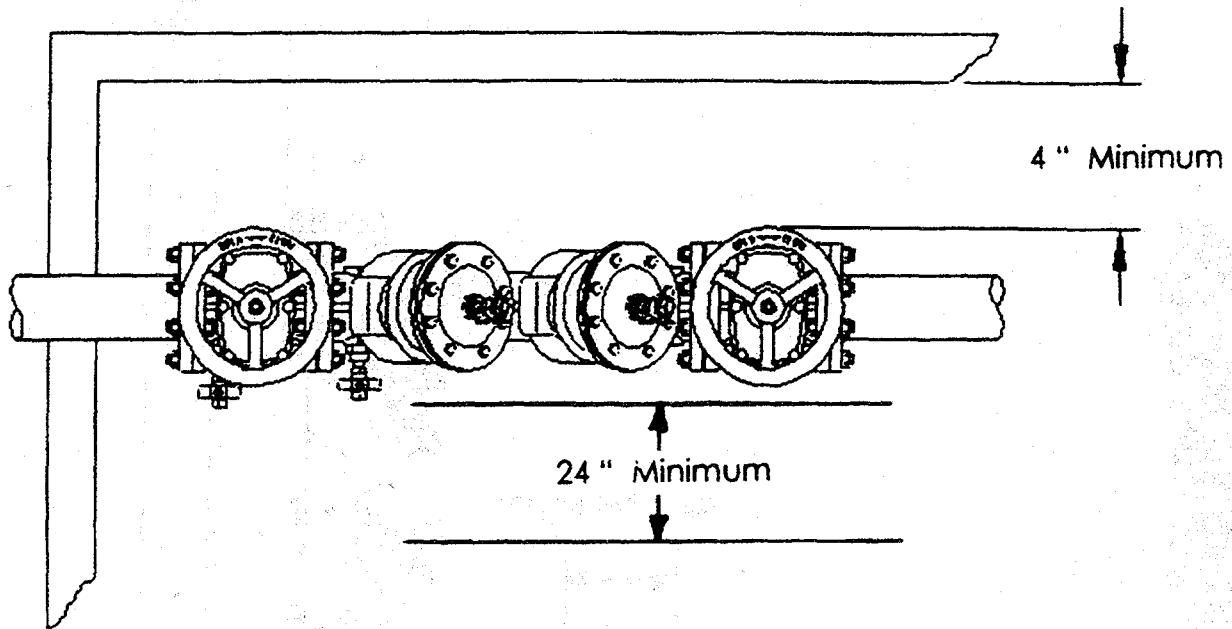

A-82.51 (3) MOBILE HOME SITES AND PARKS.

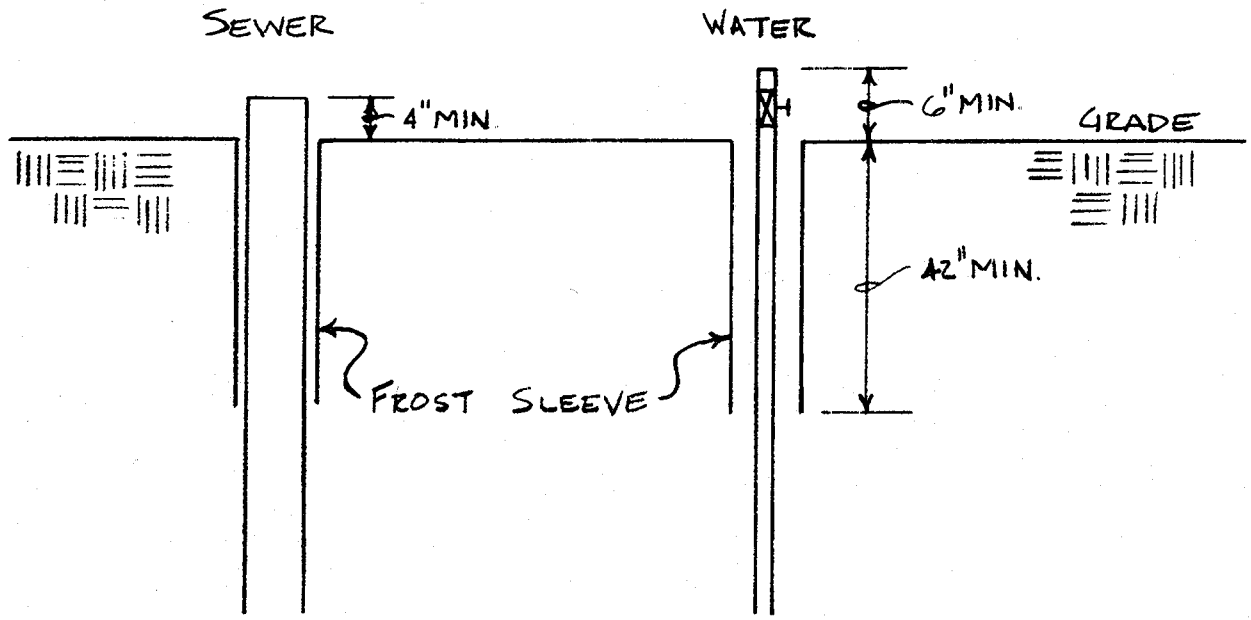

MOBILE HOME BUILDING SEWER AND WATER SERVICE TERMINATIONS