

## Chapter Comm 42

### REPAIRS, ALTERATIONS AND MISCELLANEOUS REQUIREMENTS

#### Subchapter I—

##### Welded Repairs and Alterations

Comm 42.01	General requirements.
Comm 42.02	General rules for repairs.
Comm 42.03	General rules for alterations.
Comm 42.04	Reports.
Comm 42.05	Hydrostatic and nondestructive tests.
Comm 42.06	Welding procedure specifications.
Comm 42.07	Welders.
Comm 42.08	Welded repairs of cracks.
Comm 42.09	Wasted areas.
Comm 42.10	Seal welding.
Comm 42.11	Re-ending and piecing tubes.
Comm 42.12	Materials.
Comm 42.13	Replacement pressure parts.
Comm 42.14	Welding procedures.
Comm 42.15	Preheating.
Comm 42.16	Postweld heat treatment.
Comm 42.17	Welded patches.
Comm 42.18	Stays.
Comm 42.19	Additional acceptable repair methods.
Comm 42.20	Repairs to noncode vessels.

#### Subchapter II—

##### Riveted Repairs

Comm 42.25	Riveted patches.
------------	------------------

#### Subchapter III—

##### Rerating and Derating

Comm 42.30	Rerating of a boiler or pressure vessel.
Comm 42.31	Derating of a boiler or pressure vessel.

#### Subchapter IV—

##### Safety and Safety Relief Valve Repairs

Comm 42.35	Safety and safety relief valve repairs.
------------	---

#### Subchapter V—

##### Secondhand Vessels

Comm 42.40	Application.
Comm 42.41	Existing vessels.
Comm 42.42	Vessels from out-of-state.
Comm 42.43	Lap seam boilers.
Comm 42.44	Prohibited boilers.
Comm 42.45	Inspection and testing.
Comm 42.46	Installation.

#### Subchapter VI—

##### Pressure Vessels in Petroleum Refineries

Comm 42.50	General requirements.
Comm 42.51	Adoption of API standard.

**Note:** Chapter ILHR 42 as it existed on February 29, 1988, was repealed and a new chapter ILHR 42 was created effective March 1, 1988. Chapter ILHR 42 was renumbered chapter Comm 42 under s. 13.93 (2m) (b) 1., Stats., and corrections made under s. 13.93 (2m) (b) 6. and 7., Stats., Register, March, 1999, No. 519.

#### Subchapter I—

##### Welded Repairs and Alterations

**Comm 42.01 General requirements. (1) ACCEPTABLE METHODS.** Welded repairs or alterations to any boiler or pressure vessel or their fittings, settings, or appurtenances shall be completed in accordance with the requirements of ss. Comm 42.01 to 42.20. Other methods may be acceptable provided they are approved by the department. In the absence of specific rules, the rules for new construction shall apply. Except as provided in s. Comm 42.02 (1), no welded repair or alteration may be made without the prior approval of a certified inspector who shall, if it is considered necessary, inspect the object before granting an approval.

**(2) ACCEPTANCE OF REPAIRS AND ALTERATIONS.** Repairs or alterations shall be acceptable to the certified inspector responsible for the inservice inspection of the boiler or pressure vessel. It shall be the responsibility of the organization making the repair or alteration to provide for inspection, documentation and certification of the work and to ensure prior acceptance of the procedures for the work by the inspector responsible for inservice inspection of the boiler or pressure vessel.

**History:** Cr Register, February, 1988, No. 386, eff. 3-1-88; am. (1), (2), Register, October, 1996, No. 490, eff. 11-1-96.

**Comm 42.02 General rules for repairs. (1) AUTHORIZATION.** Except as provided in sub. (1m), repairs to boilers and pressure vessels shall be performed by an organization in possession of a valid National Board repair "R" certificate of authorization, a valid ASME certificate of authorization containing provisions for welded repairs or a boiler repairer registration from the department. The repair organization shall have a documented quality control program containing a description of the scope of work they intend to perform with supporting welding procedures and qualification reports in accordance with the ASME Code Section IX. Welded repairs of a routine nature as specified in the scope

of the repair organization's quality control program may be performed without prior approval of the certified inspector.

**Note:** See s. Comm 41.06 for penalties for violations of these rules.

**(1m) EXCEPTION.** A person or entity that holds a valid authorization issued by the department to perform boiler or pressure vessel repairs may continue to repair boilers or pressure vessels until one year after the effective date of these rules.

**(2) EXAMPLES OF REPAIRS.** Repairs shall be work such as, but not limited to, the following examples:

(a) Welded repairs or replacements of pressure parts or attachments that have failed in a weld or in the base material;

(b) The addition of welded attachments to pressure parts such as, but not limited to:

1. Studs for insulation or refractory lining,
2. Hex steel or expanded metal for refractory lining,
3. Ladder clips,
4. Brackets,
5. Tray support rings,
6. Corrosion-resistant strip lining,
7. Corrosion-resistant weld overlay, and
8. Weld build-up of wasted areas.

(c) Replacement of heat exchanger tube sheets in accordance with the original design;

(d) Replacement of boiler or heat exchanger tubes where welding is involved;

(e) In a boiler, a change in the arrangement of tubes in furnace walls, economizer or superheater sections;

(f) Replacement of pressure retaining parts identical to those existing on the boiler or pressure vessel and described on the original manufacturer's data report such as, but not limited to:

1. Replacement of furnace floor tubes or sidewall tubes, or both, in a boiler,
2. Replacement of a shell or head in accordance with the original design,
3. Rewelding a circumferential or longitudinal seam in a shell or head, and
4. Replacement of nozzles;

(g) Installation of new nozzles or openings of such a size that reinforcement is not a consideration, such as the installation of a 3-inch pipe size nozzle to a shell or head of 3/8-inch or less in thickness, or the addition of a 2-inch pipe size nozzle to a shell or head of any thickness;

(h) The addition of a nozzle where reinforcement is a consideration may be considered to be a repair provided the nozzle is identical to one in the original design, is located in a similar part of the vessel, and is not closer than 3 times its diameter from another nozzle. The addition of such a nozzle shall be restricted by any service requirements;

(i) The installation of a flush patch to a boiler or pressure vessel;

(j) The replacement of a shell course in a cylindrical pressure vessel;

(k) Welding of gage holes;

(L) Welding of wasted or distorted flange faces;

(m) Replacement of slip-on flanges with weld neck flanges or vice versa; and

(n) Seal welding of butt straps and rivets.

**History:** Cr. Register, February, 1988, No. 386, eff. 3-1-88; cr. (1) eff. 12-1-88; am. (1), Register, February, 1990, No. 410, eff. 3-1-90; am. (1), cr. (1m), Register, October, 1996, No. 490, eff. 11-1-96.

**Comm 42.03 General rules for alterations.**

**(1) AUTHORIZATION.** Alterations to boilers and pressure vessels, with the exception of rerating as specified in s. Comm 42.30, shall be performed by an organization in possession of a valid ASME certificate of authorization, provided the alterations are within the scope of the authorization. The required engineering calculations shall be provided by the ASME certificate holder. When welding is necessary to complete the alteration, it shall be performed by the ASME certificate holder or an organization qualified under s. Comm 42.02 (1).

**(2) NAMEPLATE (a)** The organization responsible for the preparation of the report of alteration shall also be responsible for adding a stamping or nameplate to the boiler or pressure vessel.

**(b)** The stamping or nameplate shall be applied adjacent to the original manufacturer's stamping or nameplate in letters at least 5/32 inch high.

**(c)** The stamping or nameplate for all alterations to a boiler or pressure vessel shall be as follows:

ALTERED BY	
_____ PSIG AT _____ °F	_____
(MAWP)	(Temp)
_____	
(Manufacturer's Alteration Number, if used)	
_____	
(Date Altered)	

**(3) REPORTS.** A copy of the original manufacturer's data report and any required manufacturer's partial data reports shall be a part of the completed report of alteration and shall be attached thereto. Where the manufacturer's data report is unavailable, documentation acceptable to the department shall be submitted.

**(4) TEST.** A pressure test shall be applied after the alteration has been completed, at a pressure of at least the operating pressure, but not to exceed 150% of the maximum allowable working pressure. In lieu of a pressure test, if approved by the certified inspector, radiographic testing or ultrasonic testing may be utilized.

**Note:** Where water is used in a hydrostatic test, the temperature of the water should not be less than 70°F and the maximum temperature during inspection should not exceed 120°F. If a test is conducted at 1 1/2 times the maximum allowable working pressure (MAWP) and the owner specifies a temperature higher than 120°F, the pressure should be reduced to the MAWP and the temperature should be reduced to 120°F for the close examination.

**(5) EXAMPLES OF ALTERATIONS.** Alterations shall be work such as, but not limited to the following examples:

(a) To increase the maximum allowable working pressure or temperature of a boiler or pressure vessel regardless of whether or not a physical change was made to the boiler or pressure vessel;

(b) The addition of new nozzles or openings in a boiler or pressure vessel except those classified as repairs;

(c) A change in the dimensions or contour of a pressure vessel;

(d) In a boiler, an increase in any heating surface which results in increasing the heat output or the final temperature above that specified in the original design;

(e) The addition of a pressurized jacket to a pressure vessel;

(f) Replacement of a pressure retaining part in a boiler or pressure vessel with a material of different nominal strength or nominal composition from that used in the original design; and

(g) A decrease in the minimum temperature such that additional mechanical tests are required as specified in ASME code section VIII.

**History:** Cr. Register, February, 1988, No. 386, eff. 3-1-88; am. (1), Register, December, 1992, No. 444, eff. 1-1-93; am. (4), Register, October, 1996, No. 490, eff. 11-1-96.

**Comm 42.04 Reports. (1) GENERAL** Except as provided

in sub. (2), anyone making welded repairs or alterations in accordance with these rules shall furnish the department with a report of every welded repair or alteration. The report shall be signed by the certified inspector who inspected or approved the repair or alteration. The owner of the equipment shall retain a copy of the report for review by a certified inspector. The report shall contain the information indicated on department form SB-190 or National Board Form R-1. Form SB-190 shall be filed by organizations who do not possess an ASME certificate of authorization or a National Board R certificate.

**Note:** See Appendix A for sample copies of forms SB-190 and R-1.

**(2) EXEMPTIONS.** The following items require the prior approval of the certified inspector but are exempt only from the reporting requirements of sub. (1):

(a) The welded repair or replacement of tubes in boilers or pressure vessels; and

(b) The welded repair or replacement of piping, nozzles, valves and fittings of 2-inch nominal pipe sizes and smaller.

**(3) OTHER REQUIREMENTS.** All other requirements of this subchapter shall apply.

**History:** Cr. Register, February, 1988, No. 386, eff. 3-1-88; am. (1), (2) (intro.), Register, October, 1996, No. 490, eff. 11-1-96.

**Comm 42.05 Hydrostatic and nondestructive tests.**

If, in the opinion of the certified inspector, a hydrostatic test is necessary, the test shall be applied at a pressure of at least the operating pressure, but not to exceed 150% of the maximum allowable working pressure. In lieu of a hydrostatic test, if approved by the certified inspector, radiographic testing, ultrasonic testing, or other applicable nondestructive testing of the repair may be utilized. All tests shall be applied after the repair has been completed.

**Note:** Where water is used in a hydrostatic test, the temperature of the water should not be less than 70°F and the maximum temperature during inspection should not exceed 120°F. If a test is conducted at 1 1/2 times the maximum allowable working pressure (MAWP) and the owner specifies a temperature higher than 120°F, the pressure should be reduced to the MAWP and the temperature should be reduced to 120°F for the close examination.

**History:** Cr. Register, February, 1988, No. 386, eff. 3-1-88; am. Register, October, 1996, No. 490, eff. 11-1-96.

**Comm 42.06 Welding procedure specifications.**

Anyone undertaking repairs or alterations shall have available at the job site a written welding procedure specification acceptable to the certified inspector that shall be followed in making the necessary repair and also a record of procedure qualification tests. Welding procedure specifications shall have been prepared and

qualified in accordance with the requirements of section IX of the ASME code.

**History:** Cr Register, February, 1988, No. 386, eff. 3-1-88; am. Register, October, 1996, No. 490, eff. 11-1-96.

**Comm 42.07 Welders.** (1) **WELDER QUALIFICATIONS.** Anyone undertaking repairs or alterations shall have available at the job site records of welder qualification tests showing that each welder to be employed on the work has satisfactorily passed tests as prescribed in section IX of the ASME code.

(2) **WELDING TESTS.** Preparation of welding procedure specifications and the conducting of tests of procedures and welders shall be the responsibility of the party undertaking repairs or alterations. Before repairs or alterations are started, the certified inspector shall examine the written welding procedure and records of qualification tests to determine if procedures and welders have been properly qualified as required in section IX of the ASME code. Witnessing of the tests by the certified inspector is not mandatory, but the inspector shall have the right to call for and witness the making of test coupons by any welder, at any time, and to observe the physical testing of the coupons.

**History:** Cr Register, February, 1988, No. 386, eff. 3-1-88; am. (2), Register, October, 1996, No. 490, eff. 11-1-96.

**Comm 42.08 Welded repairs of cracks.** (1) **REMOVAL OF DEFECTS.** A repair of a defect, such as a crack in a welded joint or base material, may not be made until the defect has been removed. A suitable nondestructive examination method shall be used to assure complete removal of the defect. If the defect penetrates the full thickness of the material, the repair shall be made with a complete penetration weld such as a double butt weld or a single butt weld with or without backing.

**Note:** Before repairing a cracked area, care should be taken to investigate its cause and to determine its extent. Where circumstances indicate that the crack is likely to recur, consideration should be given to removing the cracked area and installing a patch or other corrective measures.

(2) **CRACKS IN UNSTAYED AREAS.** Cracks in unstayed shells, drums or headers of boilers or pressure vessels may be repaired by welding, providing the cracks do not extend between rivet holes in a longitudinal seam or parallel to a rivet seam within 8 inches, measured from the nearest caulking edge. The total length of any one such crack may not exceed 8 inches. Cracks of a greater length may be welded, provided the complete repair is radiographed and stress relieved in accordance with s. Comm 42.16. Cracks in unstayed areas shall be repaired as specified in Figure 42.08-1 or by other equivalent methods.

(3) **CRACKS IN STAYED AREAS.** Cracks of any length in stayed areas may be repaired by fusion welding except that multiple or star cracks radiating from rivet or staybolt holes shall not be welded. Cracks in stayed areas shall be repaired as specified in Figure 42.08-1 or by other equivalent methods.

Figure 42.08-1  
RIVET AND STAYBOLT HOLE CRACKS

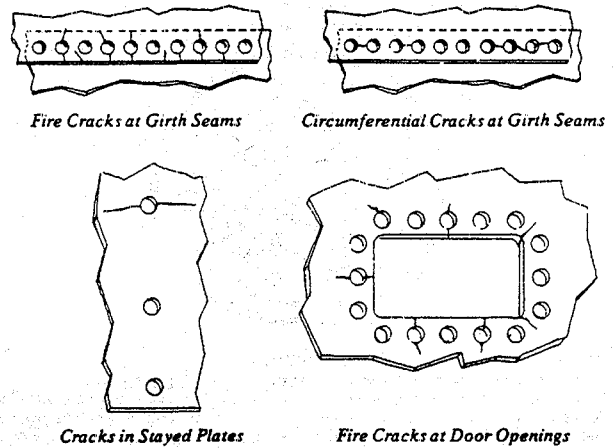

Cracks radiating from rivet or staybolt holes may be repaired if the plate is not seriously damaged. If the plate is seriously damaged, it shall be replaced. The repair method shall be as follows:

- Prior to welding, the rivets or staybolts from which the cracks extend and the adjacent rivets or staybolts shall be removed.
- In riveted joints, tack bolts shall be replaced in alternate holes to hold the plate laps firmly.
- The cracks shall then be prepared for welding by chipping, grinding or gouging.
- In riveted joints, cracks which extend past the inner edge of the plate lap shall be welded from both sides.
- Rivet holes shall be reamed before new rivets are driven.
- Threaded staybolt holes shall be retapped and new staybolts properly driven and headed.

(4) **CRACKS IN UNSTAYED FURNACES.** Cracks of any length in unstayed boiler furnaces may be welded, provided the welds are thermally stress relieved in accordance with s. Comm 42.16. Welds applied from one side only shall be subject to the approval of the certified inspector. Field repair of cracks at the knuckle or the turn of the flange of the furnace opening are prohibited unless specifically approved by the department.

**History:** Cr Register, February, 1988, No. 386, eff. 3-1-88; am. (4), Register, October, 1996, No. 490, eff. 11-1-96.

**Comm 42.09 Wasted areas.** (1) **SHELLS, DRUMS AND HEADERS.** Wasted areas in stayed and unstayed shells, drums and headers may be built up by welding provided that in the judgment of the certified inspector the strength of the structure will not be impaired. Where extensive weld build-up is employed, the authorized inspector may require an appropriate method of nondestructive examination for the complete surface of the repair. Wasted areas shall be built up by welding as specified in Figure 42.09-1 or by other equivalent methods.

(2) **ACCESS OPENINGS.** Wasted areas around access openings may be built up by welding provided that in the judgment of the certified inspector the strength of the structure will not be impaired, or they shall be repaired as specified in Figure 42.09-2 or by other equivalent methods. In boilers, the area to be repaired may not be closer than 2 inches from any knuckle.

Figure 42.09-1  
WELD BUILD-UP OF WASTED AREAS

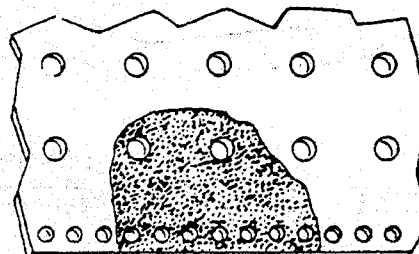

**RIVETS AND STAYBOLTS**

- a. Prior to welding, the rivets or staybolts in the wasted area shall be removed.
- b. Threaded staybolt holes shall be retapped after welding.
- c. Rivet holes shall be reamed after welding.
- d. Welding may not cover rivet or staybolt heads.

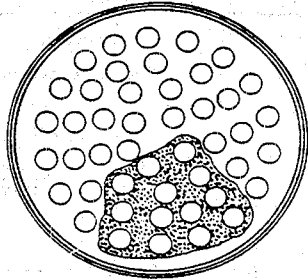

**TUBESHEET**

- a. Prior to welding, the tubes in the wasted area shall be removed.
- b. After welding, the tube holes may be reamed before new tubes are installed. Wasted areas in stayed and unstayed surfaces may be built up by welding provided that in the judgment of the authorized inspector the strength of the structure will not be impaired. Where extensive weld build-up is employed, the authorized inspector may require an appropriate method of nondestructive examination for the complete surface of the repair.

**(3) FLANGES.** (a) Wasted flange faces may be cleaned thoroughly and built up with weld metal. Built-up flange faces should be machined in place, if possible, and shall be machined to a thickness not less than that of the original flange or that required by calculations in accordance with the provisions of the applicable section of the ASME code.

(b) Wasted flange faces may also be remachined in place without building up with weld metal provided the metal removed in the process does not reduce the thickness of the flange to a measurement below that calculated in par. (a).

(c) Flanges that leak because of warpage or distortion and that cannot be repaired shall be replaced with new flanges that have at least the dimensions conforming to the applicable section of the ASME code.

**(4) TUBES.** Wasted areas on tubes may be repaired by welding provided that in the judgment of the certified inspector the strength of the tube has not been impaired. Where deemed necessary, competent technical advice shall be obtained from the manufacturer or from another qualified source. This may be necessary when considering such items as size limitations of repaired areas, minimum tube thickness to be repaired, tube environment, location of the tube in the boiler and other similar conditions.

Figure 42.09-2  
REPAIRS FOR ACCESS OPENINGS

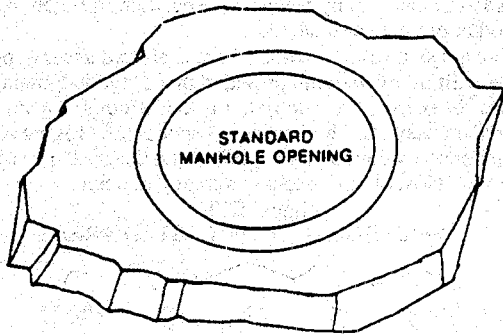

A badly wasted manhole flange may be removed and replaced with a ring-type frame as shown above. The requirements of s. Comm 42.17 (1) for flush patches shall

be met. A full penetration weld shall be required. The weld may either be double welded or welded from one side with or without a backing ring

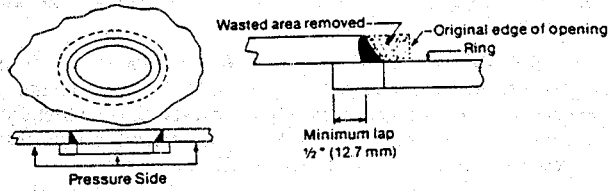

A badly wasted area around a handhole opening shall be repaired by adding a ring as shown above on the inside of the object.

**History:** Cr. Register, February, 1988, No. 386, eff. 3-1-88; am. (1), (2), (4), Register, October, 1996, No. 490, eff. 11-1-96.

**Comm 42.10 Seal welding. (1) SEAL WELDING OF TUBES.**

Tubes may be seal welded provided the ends of the tube have sufficient wall thickness to prevent burn-through and the requirements of the appropriate sections of the ASME code are satisfied. Seal welding of tubes shall be done as specified in Figure 42.10-1 or by other equivalent methods.

**(2) SEAL WELDING OF RIVETED JOINTS.** Edges of butt straps or of plate laps and nozzles or connections attached by riveting may be restored to original dimensions by welding. Seal welding may not be used except with the special approval of the certified inspector, and in no case where cracks are present in riveted areas. Seal welding shall be done as specified in Figure 42.10-2 or by other equivalent methods.

Figure 42.10-1  
SEAL WELDING OF TUBES

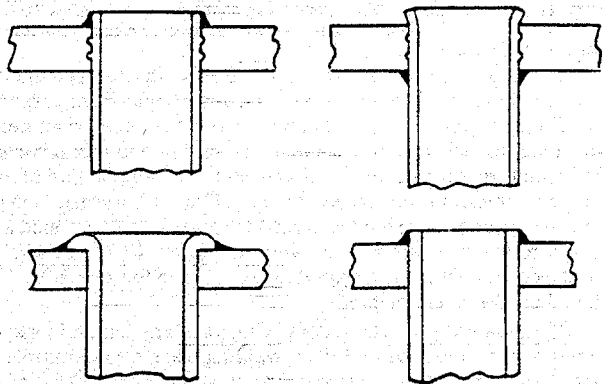

Tubes may be seal welded provided the ends of the tubes have sufficient wall thickness to prevent burn through. Seal welding shall be applied with a maximum of three light layers in lieu of one or two heavy layers.

In watertube boilers, tubes may be seal welded on the inside or outside of the tube-sheet.

Figure 42.10-2  
SEAL WELDING OF RIVETED JOINTS

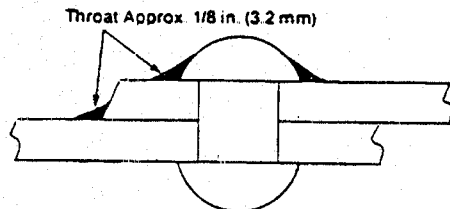

**TYPICAL RIVET JOINT SHOWING SEAL WELD**

Seal welding of riveted joints requires the approval of the department. Seal welding may not be considered a strength weld. Seal welding shall be applied in one light layer if practicable, but not more than two layers shall be used.

Prior to welding, the area shall be examined by an appropriate method of nondestructive examination to assure that there are no cracks radiating from the rivet holes.

If necessary, the rivets shall be removed to assure complete examination of the area. Seal welding may not be performed if cracks are present in riveted areas.

**History:** Cr. Register, February, 1988, No. 386, eff. 3-1-88; am. (2), Register, October, 1996, No. 490, eff. 11-1-96.

**Comm 42.11 Re-ending and piecing tubes.** Re-ending or piecing of tubes or pipes in either fire tube or water tube boilers is permitted provided the thickness of the remaining tube or pipe is not less than 90% of that required by the applicable section of the ASME code.

**History:** Cr. Register, February, 1988, No. 386, eff. 3-1-88.

**Comm 42.12 Materials.** The materials used in making repairs or alterations shall conform to the requirements of the applicable section of the ASME code. Materials shall be of known weldable quality, have at least the minimum physical properties of the material to be repaired and be compatible with the original material. The thickness of any patch shall be at least equal to, but not more than 1/8-inch greater than, the material being patched. Carbon or alloy steel having a carbon content of more than 0.35% may not be welded.

**History:** Cr. Register, February, 1988, No. 386, eff. 3-1-88.

**Comm 42.13 Replacement pressure parts.** Replacement parts shall be classified as follows:

(1) **PARTS ASSEMBLED BY FORMING.** Replacement parts which will be subject to internal or external pressure and that consist of materials which may be formed or assembled to the required shape by bending, forging or other forming methods, but on which no shop fabrication welding is performed, may be supplied as material. Material and part identification shall be supplied in the form of bills of materials and drawings with ASME code compliance certified in a statement by the parts supplier.

**Note:** Examples include seamless or welded tubes or pipe supplied separately or in bundles; forged nozzles; heads or tube sheets forged or machined from a single piece of material; subassemblies of tubes or pipe attached together mechanically.

(2) **WELDED PARTS NOT REQUIRING INSPECTION.** Replacement parts which will be subject to internal or external pressure and that are preassembled by welding, but on which shop inspection is not required by the ASME code, shall have the welding performed in accordance with section IX and other applicable sections of the ASME code. The replacement part assembly identification shall be supplied in the form of bills of material and drawings. The supplier or manufacturer shall certify that the material, design and fabrication are in accordance with the applicable section of the ASME code.

**Note:** Examples include boiler furnace panel wall or floor assemblies; prefabricated openings in boiler furnace walls such as burner openings, air ports, inspection openings or soot blower openings.

(3) **WELDED PARTS REQUIRING INSPECTION.** Replacement parts which will be subject to internal or external pressure and that are fabricated by welding and which require shop inspection by a certified inspector, shall be fabricated by a manufacturer having an ASME certificate of authorization and the appropriate code symbol stamp. The item shall be inspected, and stamped with the applicable code symbol and the word "PART". A completed manufacturer's partial data report shall be supplied by the manufacturer.

**History:** Cr. Register, February, 1988, No. 386, eff. 3-1-88; am. (3), Register, October, 1996, No. 490, eff. 11-1-96.

**Comm 42.14 Welding procedures.** Groove welds shall completely penetrate the thickness of the material being welded. If possible, welding shall be applied from both sides of the plate or a backing strip or ring may be used to ensure complete penetration. Manually applied welds shall have a convex surface on both sides if applied on both sides of the plates being joined, or on one side if welding is applied from one side only. Valleys and undercutting at edges of welded joints are not permitted. The reinforcement may be chipped, ground, or machined off flush with the base metal, if so desired, after the welding has been completed.

**History:** Cr. Register, February, 1988, No. 386, eff. 3-1-88.

**Comm 42.15 Preheating. (1) GENERAL.** Preheating may be required during welding to assist in completion of the welded joint. Where deemed necessary, advice shall be sought from a qualified source.

**Note:** See ASME code section VIII Appendix R for further explanatory information.

(2) **PREHEAT AND INTERPASS TEMPERATURES.** The welding procedure specification and qualification for the material being welded shall specify the preheat and interpass temperature requirements.

**History:** Cr. Register, February, 1988, No. 386, eff. 3-1-88.

**Comm 42.16 Postweld heat treatment. (1) GENERAL.** In repairing carbon or low alloy steels, postweld heat treatment shall be required if it would be required for new construction by the ASME code.

**Note:** Under certain conditions, postweld heat treatment as outlined in sub (1) may be inadvisable or impractical. In these instances, any other method of postweld heat treatment or special welding method acceptable to the certified inspector may be used. Examples of special welding methods for P1 and P3 materials are described in sub. (3). Where deemed necessary, competent technical advice should be obtained from the manufacturer of the object or from another qualified source.

(2) **ALTERNATIVE METHODS.** When methods other than postweld heat treatment are used, the certified inspector shall be assured that the requirements of sub. (3) are met.

(3) **WELDING METHODS AS ALTERNATIVES TO POSTWELD HEAT TREATMENT.** Two welding methods that may be used as alternatives to postweld heat treatment are given in pars. (a) and (b) as a general guide. The use of these alternatives is limited to P1 and P3 steels, and to the more routine required in boiler and pressure vessel maintenance. They may not be used in highly stressed areas, or if service conditions are conducive to stress corrosion cracking or, in some cases, to hydrogen embrittlement.

(a) **Method 1, higher preheat temperature.** 1. Material applicability. The use of method 1 shall be limited to P1 groups 1, 2 and 3 steels and P3 groups 1 and 2, except Mn-Mo, steels.

2. Method details. The materials to be welded shall be preheated to at least 300°F and maintained at this temperature during welding. The 300°F temperature shall be checked to assure that 4 inches of the steel on each side of the joint, or 4 times the plate thickness, whichever is greater, will be maintained at the minimum preheat temperature. The maximum interpass temperature shall be 450°F.

**Note:** In the use of this method it should be ascertained that the notch ductility in the as-welded condition is adequate at operating and pressure test temperatures. When this alternative meets the above requirements, any code credit for postweld heat treatment can be continued.

(b) **Method 2, half bead welding technique.** 1. Material applicability. The use of method 2 shall be limited to groups 1, 2 and 3 for both P1 and P3 steels.

2. Limitations. a. The weld metal shall be deposited by the manual shielded metal arc process using low hydrogen electrodes. The maximum bead width shall be 4 times the electrode core diameter.

b. The depth of the repair may not be greater than 3/8-inch or 10% of the base metal thickness, whichever is less, and the individual area may not be greater than 10 square inches.

c. When this method is used, it shall require the approval of the department. The certified inspector shall assure that the method has been qualified in accordance with the guidelines of section IX of the ASME code.

3. Method details. a. Step 1. The weld area shall be preheated and maintained at a minimum temperature of 350°F during welding. The maximum interpass temperature shall be 450°F.

b. Step 2. The initial layer of weld metal shall be deposited over the entire area with a 1/8-inch maximum diameter electrode. Approximately one-half the thickness of this layer shall be removed by grinding before depositing subsequent layers. Subsequent layers shall be deposited with a 5/32-inch maximum diameter electrode in a manner to ensure tempering of the prior beads and their heat affected zones. Partial removal of these subsequent

layers is not required. A final temper bead weld shall be applied to a level above the surface being repaired without contacting the base material but close enough to the edge of the underlying weld bead to assure tempering of the base material heat affected zone.

c. Step 3. The weld area shall be maintained at a temperature of 400–500°F for a minimum period of 4 hours after completion of the weld repair. The final temper bead reinforcement layer shall be removed substantially flush with the surface of the base material.

(4) JOINTS BETWEEN AUSTENITIC STAINLESS STEELS. Postweld heat treatment is neither required nor prohibited for joints between austenitic stainless steels. It may not be attempted except in accordance with the recommendations of the manufacturer of the material or the requirements of the applicable section of the ASME code.

Note: See ASME code, section VIII, division 1, paragraph UHA-105.

(5) PEENING. In lieu of postweld heat treatment of carbon steels, peening or other methods acceptable to the certified inspector may be used.

History: Cr. Register, February, 1988, No. 386, eff. 3-1-88; am. (2), (3) (b) 2. c., (5), Register, October, 1996, No. 490, eff. 11-1-96.

**Comm 42.17 Welded patches. (1) FLUSH PATCHES** The weld around a flush patch shall be a full penetration weld and the accessible surfaces shall be ground flush where required by the applicable section of the ASME code. The welds shall be subjected to the nondestructive examination method used in the original construction or an acceptable alternate. Flush welded patches shall be applied as specified in Figure 42.17-1 or by other equivalent methods.

(2) TUBE PATCHES. In some situations it is necessary to weld a flush patch on a tube, such as when replacing tube sections and accessibility around the complete circumference of the tube is restricted, or when it is necessary to repair a small bulge. This is referred to as a window patch. Window patches shall be applied as specified in Figure 42.17-2 or by other equivalent methods.

Figure 42.17-1  
FLUSH PATCHES

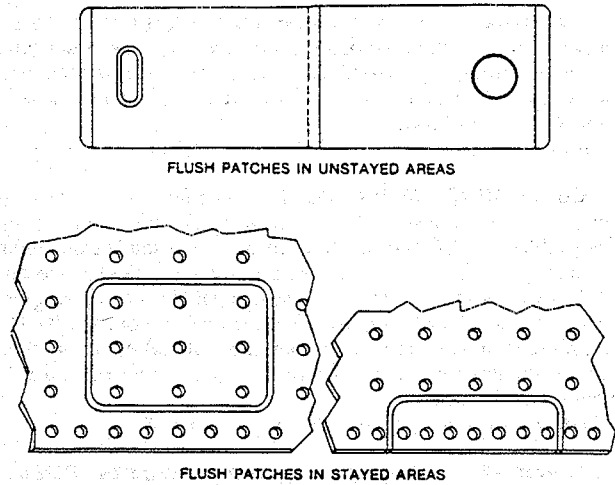

Before installing a flush patch, the defective metal shall be removed until sound metal is reached. The patch shall be rolled or pressed to the proper shape or curvature. The edges shall align without overlap.

In stayed areas, the weld seams shall come between staybolt rows or riveted seams. Patches shall be made from material that is at least equal in quality and thickness to the original material.

Patches may be of any shape or size. Corners of patches shall have a radius of such size as is necessary to avoid creating a stress point

Figure 42.17-2  
TUBE WINDOW PATCHING METHOD

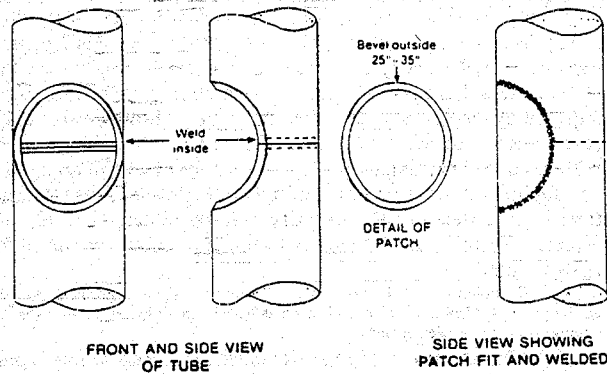

It may be necessary to weld a flush patch on a tube, since in some situations, accessibility around the complete circumference of the tube is restricted. Window patches shall be applied as follows:

- a. The patch shall be made from tube material of the same type, diameter and thickness as the one being repaired.
- b. Fitup of the patch is important to weld integrity. The root opening shall be uniform around the patch.
- c. The gas tungsten arc welding process shall be used for the initial pass on the inside of the tube and for the initial pass joining the patch to the tube.
- d. The balance of the weld may be completed by any appropriate welding process.

(3) LAPPED AND FILLET WELDED PATCHES. Lapped and fillet welded patches may be applied provided they are not exposed to radiant heat. Lapped and fillet welded patches may be applied on



the pressure side of the sheet. The maximum diameter of the opening repaired may not exceed 8 inches or 16 times the thickness of the plate. Lapped and fillet welded patches shall have a minimum lap of  $\frac{1}{2}$ -inch. If the area to be patched includes a riveted seam, rivets shall be removed before the patch is applied and new rivets driven before the patch is welded at the edges. New staybolts shall be installed in the patched area, and the heads of the staybolts shall not be covered by welding.

**History:** Cr. Register, February, 1988, No. 386, eff. 3-1-88; am. (3), Register, December, 1992, No. 444, eff. 1-1-93.

**Comm 42.18 Stays.** Threaded stays may be replaced by welded-in stays provided that in the judgment of the certified inspector the plate adjacent to the staybolt has not been materially weakened by wasting away. All requirements of the ASME code governing welded-in stays shall be met, except that stress relieving other than thermal may be used as provided in s. Comm 42.16.

**History:** Cr. Register, February, 1988, No. 386, eff. 3-1-88; am. Register, October, 1996, No. 490, eff. 11-1-96.

**Comm 42.19 Additional acceptable repair methods.** Repairs and repair methods not covered in this chapter may be used if acceptable to the certified inspector. Additional methods illustrated in Figures 42.19-1 and 42.19-2 are acceptable if performed as specified in the figures.

Figure 42.19-1  
ACCEPTABLE REPAIRS FOR CORRODED OR  
WORN HEADS OF VERTICAL TUBE OR  
SIMILAR TYPE BOILERS

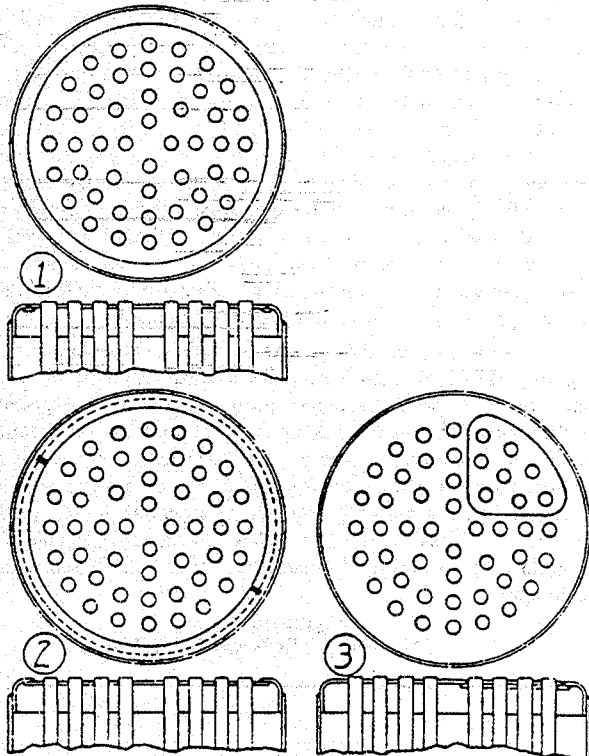

**1. Flush Butt Welded Head**

With this repair, the old head shall be cut close to the point of tangency of the knuckle of the flange, and the new head, previously drilled for tube holes and beveled for adequate welding groove, shall be butt welded to the flanged section of the old head. A back up ring, inserted in sections if necessary, shall be used to ensure weld penetration for the full head thickness.

**2. Lapped and Fillet Welded Head**

With this repair, the new head shall be lapped under the flange knuckle of the old head, previously slotted as shown to admit the new head, and then fillet welded at the edge.

**3. Segmental or Pie-Shaped Butt Welded Patch**

Figure 42.19-2  
ACCEPTABLE FURNACE RENEWAL

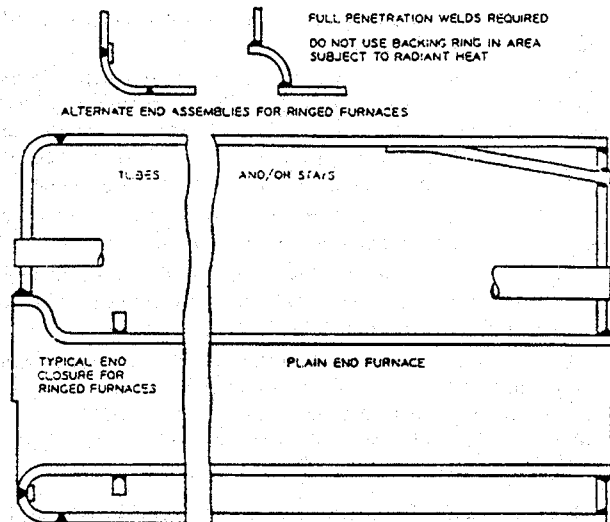

**Longitudinal seam in furnace double butt-welded and thermally stress-relieved**

For repair, the final joint to each head may be stress-relieved by peening. The furnace may be welded into a riveted boiler by using adaptable end closures. Ringed furnaces shall be thermally stress-relieved after longitudinal seam and rings have been applied.

**History:** Cr. Register, February, 1988, No. 386, eff. 3-1-88; am. Register, October, 1996, No. 490, eff. 11-1-96.

**Comm 42.20 Repairs to noncode vessels.** Welded repairs or alterations to pressure vessels not covered by section VIII of the ASME code shall be performed in accordance with the pressure vessel manufacturer's recommendations and section IX of the ASME code. If the pressure vessel manufacturer is no longer in business, recommendations of a pressure vessel design engineer may be acceptable.

**History:** Cr. Register, February, 1988, No. 386, eff. 3-1-88.

**Subchapter II—  
Riveted Repairs**

**Comm 42.25 Riveted patches. (1) GENERAL.** When riveted patches are used, they shall be designed and applied using methods acceptable to the department.

**Note:** Information regarding the use of riveted patches is available from the department and may be found in Wisconsin Administrative Code chapters Ind 41-42, Boiler and Pressure Vessel Code, Register, May, 1974, No. 221.

**(2) MATERIALS FOR RIVETED PATCHES.** Patch material shall meet the applicable requirements of s. Comm 42.12.

**(3) REPORT OF RIVETED REPAIR.** Anyone making a riveted repair shall furnish the department and the owner of the equipment with a report of the repair as specified under s. Comm 42.04.

**(4) PRESSURE TEST.** The certified inspector may require a pressure test, as specified in s. Comm 42.05, after completion of a riveted repair.

**History:** Cr. Register, February, 1988, No. 386, eff. 3-1-88; am. (4), Register, October, 1996, No. 490, eff. 11-1-96.

**Subchapter III—  
Rerating and Derating**

**Comm 42.30 Rerating of a boiler or pressure vessel.**

**(1) GENERAL REQUIREMENTS.** Rerating of a boiler or pressure vessel by increasing the maximum allowable working pressure or temperature shall be considered an alteration and may be done only after the requirements of pars. (a) to (d) have been met.

**(a) Revised calculations verifying the suitability of the vessel for the new service conditions shall be requested from the original manufacturer and shall be made available to its certified inspector. Where these calculations cannot be obtained from this source,**

they shall be prepared by an organization in possession of a valid ASME certificate of authorization, provided the alterations are within the scope of the authorization, and they shall be made available to its certified inspector.

(b) All reratings shall be established in accordance with the requirements of the code to which the boiler or pressure vessel was built, or by computation using the appropriate formulas in the edition of the ASME code listed in Table 41.10, if all essential details are known to definitely comply with this edition of the code.

(c) Current inspection records shall verify that the boiler or pressure vessel is satisfactory for the proposed service conditions.

(d) The boiler or pressure vessel rerating shall be acceptable to the certified inspector performing the periodic inspections of the object under chs. Comm 41 and 42.

(2) NAMEPLATE AND REPORT REQUIREMENTS. The requirements of s. Comm 42.03 (2)-(4) shall be met and an alteration report shall be submitted in accordance with s. Comm 42.04.

History: Cr. Register, February, 1988, No. 386, eff. 3-1-88; am. (1) (a), (d), Register, October, 1996, No. 490, eff. 11-1-96.

**Comm 42.31 Derating of a boiler or pressure vessel.**

(1) GENERAL REQUIREMENTS. Derating of a boiler or pressure vessel by decreasing the maximum allowable working pressure may be done only after the requirements of subs. (2) to (4) have been met. Derating may be initiated by the owner or the certified inspector.

(2) NAMEPLATE REQUIREMENTS. When a boiler or pressure vessel is derated, an additional nameplate shall be permanently attached. The nameplate for derating shall be as follows:

DERATED
PSIG AT _____ °F
(Wisconsin Registration Number)
(Date Derated)

(3) NAMEPLATE ATTACHMENT. Attachment of the nameplate shall be witnessed by the certified inspector.

(4) REPORTS. The certified inspector shall report the derating to the department.

History: Cr. Register, February, 1988, No. 386, eff. 3-1-88; am. (1), (3), (4), Register, October, 1996, No. 490, eff. 11-1-96.

**Subchapter IV—  
Safety and Safety Relief Valve Repairs**

**Comm 42.35 Safety and safety relief valve repairs.**

(1) DEFINITIONS. (a) Repair of a safety valve or safety relief valve means the replacement, remachining or cleaning of any critical part; lapping of seat and disc or any other operation which may affect the flow passage, capacity, function or pressure retaining integrity; and disassembly, reassembly and adjustments which affect the safety valve or safety relief valve function.

(b) Safety valves and safety relief valves on which the seals have been broken shall be subject to the requirements for repairs.

(c) The initial adjustments of a new safety valve or safety relief valve on a boiler or pressure vessel are not considered a repair if made by the manufacturer or assembler of the valve.

(2) AUTHORIZED REPAIRS. Repairs to safety valves and safety relief valves shall be performed by an organization in possession of one or more of the following:

- (a) ASME V, HV or UV code symbol stamp; or

(b) National Board VR stamp covering the work to be performed.

(3) AUTHORIZED ADJUSTMENTS. Properly trained and qualified employes of boiler or pressure vessel users may make external adjustments to set pressure and blowdown to safety valves and safety relief valves owned by them provided the adjusted settings and capacities and the date of the adjustment are recorded on a metal tag secured to the seal wire. All external adjustments shall be resealed showing the identification of the organization making the adjustments.

(4) NAMEPLATES. (a) Except as provided in sub. (3), when a safety valve or safety relief valve is repaired, a metal repair nameplate stamped with the information required by par. (b) shall be welded or otherwise permanently attached to the valve either above, adjacent to or below the original stamping. On small valves, a metal tag showing the repair nameplate information may be securely attached to the repaired valve.

(b) The information on the valve repair nameplate shall include the name of the repair organization, the symbol stamp and symbol stamp number, and the date of repair. The nameplate shall be as shown in Figure 42.35. If the set pressure has been changed, the new set pressure and capacity shall be indicated and the original nameplate or stamping shall be modified by marking out, although leaving legible, the prior set pressure and capacity. The new capacity shall be based on that for which the valve was originally certified. Only the current repair nameplate need be attached to the valve with the original or duplicate nameplate.

(5) ILLEGIBLE OR MISSING NAMEPLATES. (a) When the information on the original manufacturer's nameplate or stamping is illegible, the manufacturer's nameplate or stamping shall be augmented by a nameplate stamped "duplicate" which contains all information required by the applicable section of the ASME code, except the "V" or "UV" symbol and the NB mark. The repair organization nameplate, with the serialized "VR" stamp and other required data specified in sub. (4) (b), shall make the repairer responsible to the owner and the department that the information on the duplicate nameplate data is correct. If the owner specifies a set pressure or blowdown change, these new parameters and new capacity shall be stamped on the duplicate nameplate in addition to appearing on the valve repairer's nameplate.

(b) When the original valve manufacturer's nameplate is missing, the repair organization may not perform repairs to the valve under the "VR" program unless the valve can be positively identified and original nameplate data can be obtained from the original valve manufacturer, the repairer's inhouse sources or the National Board capacity certification. Valves that can be positively identified shall be equipped with a duplicate nameplate as described in par. (a) as well as the repairer's "VR" stamped nameplate. The repairer's responsibilities for data accuracy as identified in par. (a) shall apply.

Figure 42.35  
VALVE REPAIR NAMEPLATE

(name of valve repair firm)
(set pressure) _____ (capacity)
(date of repair)
No. _____
(Symbol stamp no.) _____

Note: The nameplate should be stamped with the valve repair symbol stamp.



**Note:** Capacity should be indicated only when set pressure has been changed.

**History:** Cr. Register, February, 1988, No. 386, eff. 3-1-88; am. (2) (a), (b), (2) (c), am. (3), Register, October, 1996, No. 490, eff. 11-1-96.

### Subchapter V— Secondhand Vessels

**Comm 42.40 Application.** Sections Comm 42.40 to 42.46 shall apply to secondhand boilers and secondhand pressure vessels.

**History:** Cr. Register, February, 1988, No. 386, eff. 3-1-88.

**Comm 42.41 Existing vessels.** Secondhand boilers and secondhand pressure vessels, originally installed in Wisconsin and not constructed and stamped according to some edition of the ASME Code, may be reinstalled if the maximum allowable working pressure is recalculated with a factor of safety of 6.

**History:** Cr. Register, February, 1988, No. 386, eff. 3-1-88.

**Comm 42.42 Vessels from out-of-state.** Secondhand boilers and secondhand pressure vessels, from out-of-state, shall be constructed and stamped according to some edition of the ASME Code. A copy of the manufacturer's data report shall be furnished to the department for each vessel indicating that it was manufactured originally to the requirements of an earlier edition of the applicable ASME code. If a vessel has been repaired or altered since its fabrication, a copy of the manufacturer's data report, welded repair report or alteration report shall be furnished to the department.

**History:** Cr. Register, February, 1988, No. 386, eff. 3-1-88.

**Comm 42.43 Lap seam boilers.** Secondhand boilers which have lap seam construction and which are larger than 36 inches in diameter shall be limited to a maximum allowable working pressure of not more than 15 pounds per square inch.

**History:** Cr. Register, February, 1988, No. 386, eff. 3-1-88.

**Comm 42.44 Prohibited boilers.** The installation of secondhand boilers which have the longitudinal joint exposed to the intense heat of the furnace is prohibited. The locomotive or inside butt strap may not be considered as strengthening or changing the original type of boiler joint.

**History:** Cr. Register, February, 1988, No. 386, eff. 3-1-88.

**Comm 42.45 Inspection and testing.** (1) **HYDROSTATIC PRESSURE TEST.** Every secondhand vessel shall be inspected and given a hydrostatic pressure test at one and one-half times the maximum allowable working pressure at its new point of installation location before it is placed in operation. The test shall be witnessed by a certified inspector.

(2) **ALTERNATE TESTS.** When the certified inspector determines that a hydrostatic test at one and one-half times the maxi-

mum allowable working pressure is not possible or desirable, the authorized inspector may accept alternate means to determine if the vessel is safe for its intended use.

**Note:** Where water is used in a hydrostatic test, the temperature of the water should not be less than 70°F and the maximum temperature during inspection should not exceed 120°F. If a test is conducted at 1½ times the maximum allowable working pressure (MAWP) and the owner specifies a temperature higher than 120°F, the pressure should be reduced to the MAWP and the temperature should be reduced to 120°F for the close examination.

(3) **EXEMPT VESSELS.** Boilers and pressure vessels used for portable or emergency use shall be exempt from secondhand vessel test requirements.

**History:** Cr. Register, February, 1988, No. 386, eff. 3-1-88; cr. (3), Register, February, 1990, No. 410, eff. 3-1-90; am. (1), (2), Register, October, 1996, No. 490, eff. 11-1-96.

**Comm 42.46 Installation.** Except for vessels exempted in s. Comm 41.18, all secondhand vessels when reinstalled, shall comply with the ASME codes listed in s. Comm 41.10 in regard to fittings, appliances, valves, connections, settings and supports. These vessels shall also comply with the installation and certificate of operation requirements in chs. Comm 41 and 42.

**History:** Cr. Register, February, 1988, No. 386, eff. 3-1-88.

### Subchapter VI— Pressure Vessels in Petroleum Refineries

**Comm 42.50 General requirements.** Pressure vessels in petroleum refineries shall comply with the standards specified in the American Petroleum Institute (API) Standard ANSI/API 510—Pressure Vessel Inspection Code, as adopted by reference in s. Comm 42.51.

**History:** Cr. Register, February, 1988, No. 386, eff. 3-1-88.

**Comm 42.51 Adoption of API standard.** (1) **CONSENT TO INCORPORATE.** Pursuant to s. 227.21, Stats., the attorney general and the revisor of statutes have consented to the incorporation by reference of the American Petroleum Institute (API) Pressure Vessel Inspection Code, ANSI/API 510-1992.

(2) **INTERIM AMENDMENTS.** Interim amendments of the standard in reference shall have no effect in the state until the time that this section is revised to reflect those changes.

(3) **AVAILABILITY OF STANDARDS.** The standard in reference may be obtained at a reasonable cost from the American Petroleum Institute, 1220 L Street, Northwest, Washington, D.C. 20005.

(4) **FILING OF STANDARDS.** The standard in reference is on file in the offices of the department, the secretary of state and the revisor of statutes.

**History:** Cr. Register, February, 1988, No. 386, eff. 3-1-88; am. (1), Register, May, 1994, No. 461, eff. 6-1-94.