

## Chapter Trans 207

DESIGN AND CONSTRUCTION OF MUNICIPAL HIGHWAY  
BRIDGES IN OR OVER NAVIGABLE STREAMS

Trans 207.01	Purpose (p. 379)	Trans 207.08	Waterway alterations (p. 384)
Trans 207.02	Applicability (p. 380)	Trans 207.09	Erosion control (p. 384)
Trans 207.03	Responsibilities of constructing authorities (p. 380)	Trans 207.10	Construction methods (p. 386)
Trans 207.04	Definitions (p. 380)	Trans 207.11	Notification to department of natural resources (p. 387)
Trans 207.05	Requirements of a conceptual plan (p. 383)	Trans 207.12	Public notices (p. 388)
Trans 207.06	Required navigational clearance (p. 383)	Trans 207.13	Enforcement (p. 388)
Trans 207.07	Flood flow requirements (p. 384)		

**Trans 207.01 Purpose.** The purpose of this chapter is to interpret and implement s. 84.01 (23), Stats., relating to providing standards and specifications for the design and construction of municipal public highway bridges, arches, and culverts over and in navigable streams to prevent undue impairment of public rights in navigable waters. In adopting these standards the department of transportation has followed these general guidelines.

(1) Constructing authorities are not empowered to block passage completely on any navigable stream, but on the other hand it is unreasonable to expect that unlimited overhead clearance be allowed on all streams. This means that a consideration of navigation blockage usually narrows to a question of degree of restriction: "How much physical restriction is possible at the site without preventing the movement of people, goods, and equipment that would reasonably be expected to pass through the site?"

(2) A constructing authority, in developing a rationale for partial restriction, shall not base such a rationale solely on highway needs and bridge costs but also on the fact that some sort of navigation is possible through the site and it will be accommodated by the proposed highway-water crossing.

(3) In an area only accessible by canoes, a drainage structure could conceivably be placed which was too small to accommodate a canoe. A portage route would have to be available, however, which was freely open to the public. In this way "passage" is assured for the type of navigation reasonably expected at the site.

(4) The portage concept is only reasonable in an area where the craft and equipment concerned can reasonably be carried by one or 2 persons for a short distance.

(5) In some cases, providing a sufficient pass-through clearance for vessels and flood water will still not be enough to accommodate the associated incidents of navigation. For example, it may be in the public interest to span an area of critical habitat as well. All of the pertinent factors encountered at each highway-water crossing must receive due consideration.

(6) New highway bridges or replacements of existing highway bridges over or in navigable waters shall minimize alteration of critical features of water habitats.

History: Cr. Register, June, 1981, No. 306, eff. 7-1-81.

**Trans 207.02 Applicability.** (1) COUNTY, TOWN, VILLAGE AND CITY HIGHWAY BRIDGES. (a) Pursuant to s. 84.01 (23), Stats., the standards in this chapter apply to the construction of county, town, village, and city highway bridges, arches, and culverts in or over navigable streams. The standards do not apply to projects under the supervision of the department that are done in compliance with s. 30.12 (4), Stats.

(b) These standards also apply to highway approaches to structures, but only within the physical areas defined in sub. (2) and only to those features of the proposed construction which would have an effect on water quality and other water-related aspects as described in this chapter.

(2) APPLICABLE AREA LIMITS OF HIGHWAY APPROACHES TO STRUCTURES.

(a) All portions of a highway-water crossing which are proposed for construction and lie within the floodplain are within the purview of these standards, except that in those cases where the highway approach lies roughly parallel to the waterway but within the flood plain, the portion of highway approach under the purview of these standards shall approximate the distance from the structure abutment to the floodplain limit assuming a right-angle crossing.

(b) It is not the intent of these standards that the scope of what is proposed for construction be expanded solely for the purpose of including portions of existing adjacent roadways which are within the limits of the floodplain and not in conformance with the erosion control criteria established in s. Trans 207.09 except that overflow sections shall be addressed as provided in s. Trans 207.09 (3) (b).

(3) PERMITS FROM FEDERAL AGENCIES. In addition to complying with these standards, it may be necessary for constructing authorities to obtain permits from federal agencies such as the U.S. coast guard and the U.S. army corps of engineers.

History: Cr. Register, June, 1981, No. 306, eff. 7-1-81.

**Trans 207.03 Responsibilities of constructing authorities.** (1) Prior to the execution of construction contracts or work orders a certification shall be made by the constructing authorities that the standards of this chapter have been observed in the project design and will be observed through the construction phase.

(2) Town boards or village boards receiving county aid for construction under the provisions of s. 81.38, Stats., may defer responsibility of certification to the county if full charge of the work has been left to the county highway committee as set forth in s. 81.38 (4), Stats.

Note: Responsible officials should be aware that structures shall conform to this chapter to obtain funding under s. 81.38 (5), Stats.

History: Cr. Register, June, 1981, No. 306, eff. 7-1-81.

**Trans 207.04 Definitions.** (1) "Active stream erosion zone" means that portion of the roadway embankment at bridge abutments or ends of culverts and arches which, in conjunction with the structure, gives shape to the waterway opening and is directly exposed to flowing water during a

regional flood or lesser flows. (See Figures 1, 2 & 3). Boundaries of this zone are as follows:

(a) Lateral or side boundaries lie on each side of the stream running roughly parallel to it. For bridges these boundaries are located 10 feet behind (away from the stream) each abutment face. For culverts and arches they are located 10 feet behind the inside face of the walls nearest the stream bank.

(b) The upper boundary is 2 feet above the surface of the water occurring at the time of the regional flood, upstream and downstream.

(c) The upstream boundary or limit is defined to be located at the farthest upstream disturbance to the stream-bed by construction activities.

(d) The downstream boundary or limit is defined to be located at the farthest downstream disturbance to the stream-bed or the point that stream current velocities have stabilized to the natural current conditions of the stream, whichever is further downstream.

(2) "Clearance" means the distance between the inside top of the culvert or the bottom of the lowest member of the bridge span and the elevation of the ordinary high watermark of the waterway.

(3) "Conceptual plan" means preliminary drawings, maps, and sufficient amplifying material to illustrate the intended action.

(4) "Constructing authorities" means the responsible governing bodies of counties, towns, villages, and cities as they may act or appropriately delegate.

(5) "Department" means the Wisconsin department of transportation.

(6) "Erosion bale" means a bale of straw, hay or other suitable material designed to form checks or dikes to control erosion.

(7) "Floodplain" as defined by ch. NR 116 Wis. Adm. Code and this chapter means the land which has been or may be hereafter covered by flood water during the regional flood.

(8) "Highway bridge", for the purposes of this rule, means any city, town, village, or county-owned bridge, arch, or culvert built in or over a navigable stream for public highway purposes.

(9) "Highway water crossing" means that combination of highway bridge and roadway necessary to provide a public highway across, over, or in navigable streams.

(10) "Minor replacement" means the simple replacement of an existing structure with an equivalent or larger sized manufactured structure in approximately the same location. To be classified in this category a highway-water crossing must meet all of the following conditions:

(a) The cross-sectional area of the existing structure must be no greater than 50 square feet.

(b) The gradeline of any existing overflow sections, as defined in s. Trans 207.04 (12), passing a portion of the regional flood will not be raised.

(c) The existing highway water-crossing must have a history of adequately passing flood water and be free of significant controversy concerning public rights in navigable waters.

(d) Below the regional flood level the proposed road grade and structure must have water passing characteristics at least as effective as the existing road grade and structure.

(e) The proposed structure must be manufactured away from the site, but can be assembled at the site. Constructing authorities can construct concrete structures poured at the site, but these cannot be classified as "minor replacement".

(11) "Ordinary high watermark" means the point on the banks or shore up to which the presence and action of water is so continuous as to leave a distinct mark either by erosion or destruction of terrestrial vegetation, or other easily recognizable characteristics.

Note: "Ordinary high watermark" originated in a 1914 Wisconsin supreme court case (*Diana Shooting Club v. Husting*) and has been a principal consideration in state regulation of navigable waterways since that time. It is the landward limit of the bed of a navigable body of water. This standard relies directly on the ordinary high watermark concept.

(12) "Overflow section" in a highway-water crossing means a segment of the highway gradeline which will be low enough to allow a portion of the streamflow to pass over the top of the roadway as a relief to the structure during periods of high water.

(13) "Public highway" means any highway, road, street or alley which is open for public use and is maintained and administered by any county, town, village or city.

(14) "Regional flood" means a flood determined to be representative of large floods known to have generally occurred in Wisconsin and which may be expected to occur on a particular stream because of like physical characteristics. This definition is intended to parallel the definition of "regional flood" found in s. NR 116.03 (24) Wis. Adm. Code as of August 1, 1980.

(15) "Riprap" means a quantity of durable stones or concrete pieces of varying size and shape, placed as a protective layer over soil in such a manner that the smaller pieces fill the spaces between the larger pieces. Concrete pieces are less desirable than stones for this use and those with exposed reinforcing rods shall not be used.

(a) Regular riprap stone pieces for regular riprap, except those used for chinking, shall range in weight from approximately 25 to 150 pounds, with not less than approximately 50% of the pieces weighing more than 60 pounds. Regular riprap shall be at least 12 inches in thickness, measured perpendicular to the slope.

(b) Heavy riprap stone pieces shall range in weight up to 400 pounds or more. Not less than approximately 50% of the total volume shall consist of pieces weighing 150 pounds or more, and not less than approximately 80% of the total volume shall consist of pieces weighing 40 pounds or more. Heavy riprap may be placed by any mechanical means which will produce a reasonably uniform surface texture. Heavy riprap shall be not less than 24 inches in thickness.

(16) "Waterway" means any stream which is navigable pursuant to s. 30.10, Stats.

History: Cr. Register, June, 1981, No. 306, eff. 7-1-81.

**Trans 207.05 Requirements of a conceptual plan.** (1) If a highway-water crossing is a minor replacement as described under Trans 207.04 (10), the conceptual plan need only consist of a county map noting the site location and sufficient information to establish that the proposal meets the conditions set forth under Trans 207.04 (10). As a minimum, this would be a description of the existing and proposed structure with a comparative flowline elevation.

(2) All other replacements shall require the following information as part of the conceptual plan:

(a) Site Map with a minimum scale of 1" = 660' and a minimum area of coverage must include the width of the floodplain and extend ¼ mile upstream and ¼ mile downstream from site. Principal topographic features and the proposed highway and structure layout shall be shown. Contours are desirable but not mandatory. They can be aerial photos or based on an aerial photo.

Note: Appropriate sources for maps include those from USGS and ASCS.

(b) Profiles along centerline of roadway and center of stream bed, showing groundline, stream bottom, finished grade of road, elevation of upstream regional flood water if known, datum elevation, and at least one identifiable bench mark and reference elevation.

Note: Datum elevation may be mean sea level or locally assumed.

(c) Sketch of proposed structure, minimum scale 1" = 50', plan and profile view, major dimensions shown.

(d) If the proposed structure is the replacement of an existing structure, sketch and describe the existing structure. Show an existing hydraulic cross-section of the structure including any related roadway overflow sections which form the waterway opening passing the regional flood.

(e) Data shall include general dimensions, type and material of proposed structure, hydraulic data including regional flood backwater at the structure, if known, type of roadway fill, temporary and permanent erosion control features, elevation of water surface profile which has been established by zoning ordinance if any, and muck and peat excavation and disposal.

Note: All or part of these requirements may be waived as stated in s. Trans 207.11.

History: Cr. Register, June, 1981, No. 306, eff. 7-1-81.

**Trans 207.06 Required navigational clearance.** (1) New structures or replacements of existing highway structures in or over navigable waterways shall, except as set forth herein, maintain a clearance of not less than 5 feet.

(2) More clearance than 5 feet is necessary when the waterway has been, or is likely to be navigated when water levels are above the ordinary high watermark elevation or when the waterway is used by craft requiring greater clearance.

## Trans 207

- (3) Less than 5 feet of clearance may be sufficient when:
- (a) The waterway is known to have little or no navigational use;
  - (b) The waterway is not anticipated to have navigational use by other than lightweight craft;
  - (c) A portage is provided over or around the structure;
  - (d) The reduced clearance is not detrimental to the public interest.

History: Cr. Register, June, 1981, No. 306, eff. 7-1-81.

**Trans 207.07 Flood flow requirements.** New highway structures or replacements of existing highway structures and approaches over or in navigable waters shall conform with the requirements of ch. NR 116 Wis. Adm. Code. Such structures shall comply with any applicable local floodplain or other zoning ordinance.

History: Cr. Register, June, 1981, No. 306, eff. 7-1-81.

**Trans 207.08 Waterway alterations.** Nothing in these rules authorizes any permanent or temporary change in the course of a navigable stream, or removal of material from the bed of any waterway without proper authority from the department of natural resources under ss. 30.195 and 30.20, Stats. Excavation in the stream bed, sufficient to place structure elements, is considered a necessary part of placing the structure.

History: Cr. Register, June, 1981, No. 306, eff. 7-1-81.

**Trans 207.09 Erosion control.** (1) Protection of exposed earth slopes, slope steepness limits, and areas of required treatment described in this section constitute the minimum erosion control treatment required, although they should be adequate for most streams. Consistent with sound erosion control practices, however, each site shall be evaluated on its own merits and notwithstanding s. Trans 207.02 (2) (a), the area of protection shall be increased to minimize siltation of navigable waters. Constructing authorities shall be guided by those provisions of the *Standard Specifications for Road and Bridge Construction* of the Wisconsin Department of Transportation (Edition of 1975) regarding erosion control. Copies of this volume may be obtained from the Wisconsin Department of Transportation, Construction Section, P.O. Box 7916, Madison, Wisconsin 53707, and are also on file at the offices of the Department of Transportation, (4802 Sheboygan Avenue, Madison), the Secretary of State (244 W. Washington Avenue, Madison), and the Revisor of Statutes (411-W, State Capitol, Madison).

(2) **WITHIN ACTIVE STREAM EROSION ZONE.** (a) Bridges. (See figures 1 and 2.) All exposed earth slopes which are part of the highway embankment or cut in the immediate structure area shall be protected with heavy riprap or equally effective erosion control treatment if such slopes are steeper than 6:1. The maximum earth slope steepness shall be 1-½:1.

(b) Culverts and arches. (See figure 3)

1. Upstream—When water velocities and/or soil conditions warrant such, the upstream end shall have end walls or suitable inlet devices to maintain a stabilized, non-erosive stream gradient upstream and to facilitate blending of earth fill slopes to the structure. Earth fill slopes shall be no steeper than 2:1 and, as a minimum, shall be blanketed with topsoil and established with grass cover. If earth slopes will be exposed to erod-

ible water velocities they shall be protected with regular riprap or equally effective erosion control material. Culverts and arches functioning under hydraulic high-velocity, inlet-control conditions subject to soil washout along the outside of the barrel shall be equipped with a suitable barrel collar near the inlet end.

2. Downstream—When water velocities discharging from the structure exceed that of the natural current immediately downstream and erosion is probable, the downstream end shall have end walls or devices to facilitate blending of fill-slopes to the structure with a maximum earth-slope of 2:1. All earth slopes shall be blanketed with topsoil and established with grass cover. Sufficient stream bottom protection and energy-dissipation devices shall be used to establish flow conditions which are compatible with the natural conditions without appreciable erosion of the streambed. Such devices can be regular riprap, heavy riprap, concrete pavement with or without energy-dissipating blocks, ponded outlets, or combinations of these or similar devices. Sufficient cut-off walls to preclude water undermining of pavement slabs or the structure shall be utilized.

(c) Streambanks—All exposed earth streambank slopes which are shaped, disturbed, or created to properly fit the stream to the structure shall be blanketed with riprap or equally effective erosion control treatment if such slopes are steeper than 4:1. The maximum slope steepness shall be 2:1. All such slopes which are 4:1 or flatter shall, as a minimum, be blanketed with topsoil and established with grass cover, except that in areas where the curvature of the stream is such that the flow is directed against the streambank, riprap or equally effective erosion control treatment shall be employed. This paragraph applies to all streambanks within the active stream erosion zone except in the immediate structure area where the highway approach embankment or cut acts as the streambank.

(3) OUTSIDE ACTIVE STREAM EROSION ZONE. (a) Embankments—For roadway approaches to the structure between the active stream erosion zone and the floodplain limit as described under Trans 207.02, maximum steepness of fill slopes and minimum erosion control measures shall conform to Table 1.

TABLE 1

Embankment Material	Maximum Side Slope Steepness	Minimum Erosion Control
Clays	3½:1	Topsoil, Fertilizer, Grass Cover
Silt-Silty Clays	3:1	Topsoil, Fertilizer, Grass Cover
Silty Sand or Fine Sand	2½:1	Topsoil, Fertilizer, Grass Cover
Sand or Sand and Gravel	2½:1	Topsoil, Fertilizer, Grass Cover
Rock Fragments	1½:1	Normally Needs No Erosion Cover

(b) **Overflow Sections**—When water will periodically overtop the road, from the regional or lesser floods, constructing authorities shall evaluate the frequency of overtopping, probability of road washout, and the probable detrimental effects of such a washout, including siltation of sensitive environmental and other areas. When the probable adverse effects are demonstrably worse than would be expected from the natural stream actions at equivalent flood stages, sufficient erosion control measures shall be employed to control or diminish the washout.

(c) **Roadside and crossroad drainage discharging onto floodplain or into navigable waters**—Roadside ditches in the flood plain shall, as a minimum, be covered with topsoil and established with grass. Mulching or other treatment, as necessary, shall be used to control erosion until grass is established. For ditch grades steeper than 1%, and where erosive soil conditions exist, combinations of sod, paved ditch, riprap, check dams or other similar devices shall be used as necessary to preclude, as far as practicable, siltation of navigable waters. Areas where roadside drainage discharges onto the floodplain or into the stream shall be provided with suitable erosion control devices to maintain a stable, non-erosive condition.

History: Cr. Register, June, 1981, No. 306, eff. 7-1-81.

**Trans 207.10 Construction methods.** (1) **TEMPORARY NAVIGATIONAL CLEARANCE.** In the placement of all construction forms, bracing, and falsework in or over navigable waters, as much clearance as is practicable shall be provided, consistent with the character and volume of navigational traffic and the duration of the construction phase.

(2) **TEMPORARY WATERWAY OPENING.** Consistent with stream flows reasonably predictable during the time period of use, temporary structures shall have sufficient waterway opening, either inherent in the structure or combined with an overflow area, to prevent damage from back-up of water and downstream siltation due to washout or scouring of temporary facilities.

Register, December, 1987, No. 384



(3) **TEMPORARY EROSION CONTROL.** Constructing authorities shall ensure that contractors or municipal employes perform all construction activities in such a way as to minimize the contamination of the stream by silt, debris, or toxic materials. Temporary erosion control measures such as ditch dams, settling ponds, erosion bales, and others shall be used for this purpose. When erosion bales are used, they shall be placed in accordance with Figure 4.

(4) **TIMING OF CONSTRUCTION.** Construction activities shall be undertaken and planned for completion during such seasons and weather conditions as to minimize adverse impacts on fish spawning activities, flood water elevations, and public recreation activities.

(5) **REMOVAL OF OLD STRUCTURES.** (a) Old structures shall be removed if they are no longer to be used for highway purposes unless it is deemed to be in the public interest to leave such structures intact for recreational or other use. In such cases the structure no longer has the legal status of a highway structure. Firm arrangements shall be made for future responsibility and maintenance if structures are to remain in place.

(b) 1. When structures are removed, all substructure units shall be removed to an elevation 2 feet below the groundline remaining after any shaping in above-water areas, and level with the stream bed elevation in submerged areas.

2. Old abutment fills shall be shaped so as to blend into the adjoining terrain.

3. If unusual circumstances appear to warrant leaving old substructure units or abutment fills within the area defined by the ordinary high watermark and at a higher elevation than the stream bed elevation, constructing authorities must notify the department of natural resources and obtain concurrence that to do so is in the public interest.

(6) **EXCAVATION AND DISPOSAL OF PEAT, MULCH, OR OTHER UNSUITABLE EMBANKMENT OR FOUNDATION MATERIAL.** (a) Excavation of organic or other material found not suitable to carry embankment loading shall be done in such a manner so as to preclude, as far as practicable, washing of piled-up material into navigable waters. Sufficient crossroad and toe of fill drainage shall be provided to maintain the natural continuity of ground water flow. The extent of lateral upheaval shall be estimated and shall be considered as part of the effects which may necessitate changing locations or taking other mitigating measures.

(b) Organic and unsuitable material may normally be disposed of on the sides of embankments, unless a sensitive or unique environmental situation necessitates removal and disposal on a less sensitive site. Highly polluted or toxic materials excavated must be disposed of under state laws and regulations governing such material.

History: Cr. Register, June, 1981, No. 306, eff. 7-1-81.

**Trans 207.11 Notification to department of natural resources.** (1) In the early stages of consideration of a proposed construction or reconstruction of a highway structure in or over navigable waters, constructing authorities shall notify the appropriate district office of the department of natural resources of the intended construction. Such notice shall consist of a conceptual plan. The constructing authority may request information concerning ordinary high watermark elevation, and the naviga-

tional clearance considered appropriate for the site and critical habitat that may be affected by the project, including water and wetland habitat, and spawning and nesting areas. All or part of the conceptual plan requirements may be waived by the department of natural resources if early coordination reveals in its opinion, that planned activities have no adverse effect.

(2) The department of natural resources shall have 30 days to comment and may, for good cause, request an extension of 10 days. If no response or request for extension is received within the 30-day period, or if an extension is granted and no response is received during the 10 days, project development may proceed as planned. If environmental concerns are noted, constructing authorities shall examine such concerns and act in such manner as to prevent undue impairment of public rights in navigable waters.

History: Cr. Register, June, 1981, No. 306, eff. 7-1-81.

**Trans 207.12 Public notices.** (1) If a proposed structure is a new structure, or will be a reduction of existing navigation clearance, or is replacement of an existing structure which is in itself the limiting obstruction, a Class I legal notice shall be published, and public notices shall be posted in conspicuous locations in the locality of the proposed structure. Such notices, giving the facts and place where public comments may be received, shall be published and posted at least 30 days prior to the decision on navigational clearance by the constructing authority. Public notice is not required for a minor replacement.

(2) Requirements for public notices may be combined with other requirements for similar notices relating to the proposed structure or the associated highway construction.

(3) The department of natural resources shall make a record of all project notifications received under s. Trans 207.11, and shall furnish a copy of this record on a monthly basis to any person upon written request.

History: Cr. Register, June, 1981, No. 306, eff. 7-1-81.

**Trans 207.13 Enforcement.** Municipalities are subject to proceedings which may be initiated under the Wisconsin Statutes.

Note: For example, under s. 30.03, Stats., the department of natural resources may hold a hearing on a possible violation of a statute relating to navigable waters or a possible infringement of the public rights therein and may thereafter order the performance of actions it deems necessary to protect the interests of the public.

History: Cr. Register, June, 1981, No. 306, eff. 7-1-81.

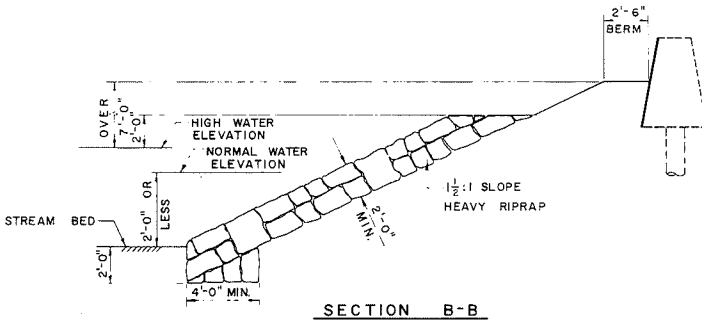
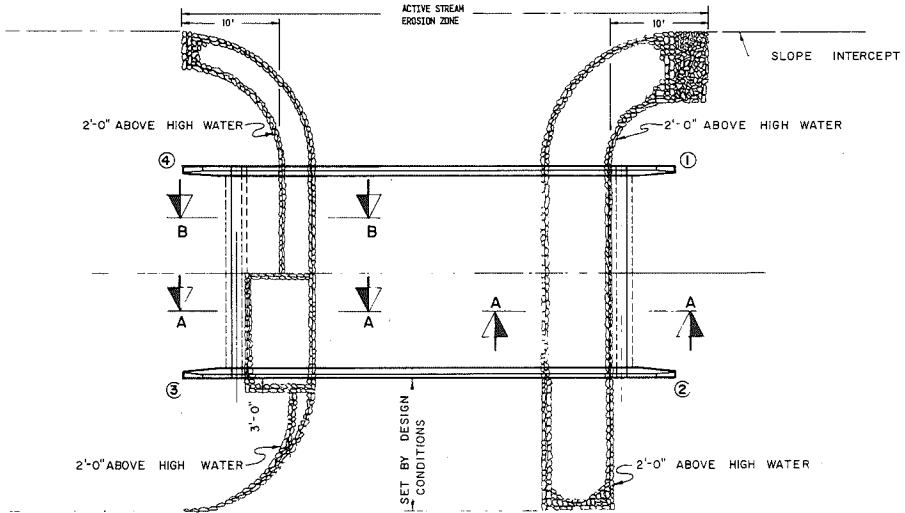

ALTERNATE ①  
NORMAL CONDITION FOR EMBANKMENT FILLS.

ALTERNATE ②  
FOR CHANNEL CHANGE CONDITION

ALTERNATE ③  
USE WHERE BERM ELEVATION IS LESS THAN 7'-0" ABOVE HIGH WATER

ALTERNATE ④  
USE WHERE BERM ELEVATION IS OVER 7'-0" ABOVE HIGH WATER

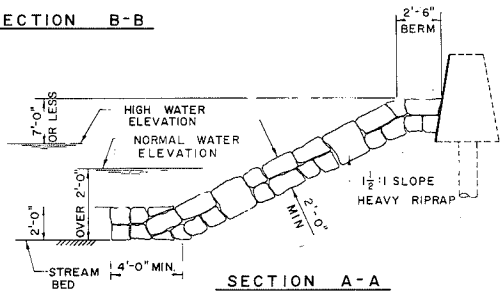

ACTIVE STREAM EROSION ZONE  
BRIDGES—SILL TYPE ABUTMENT

FIGURE 1

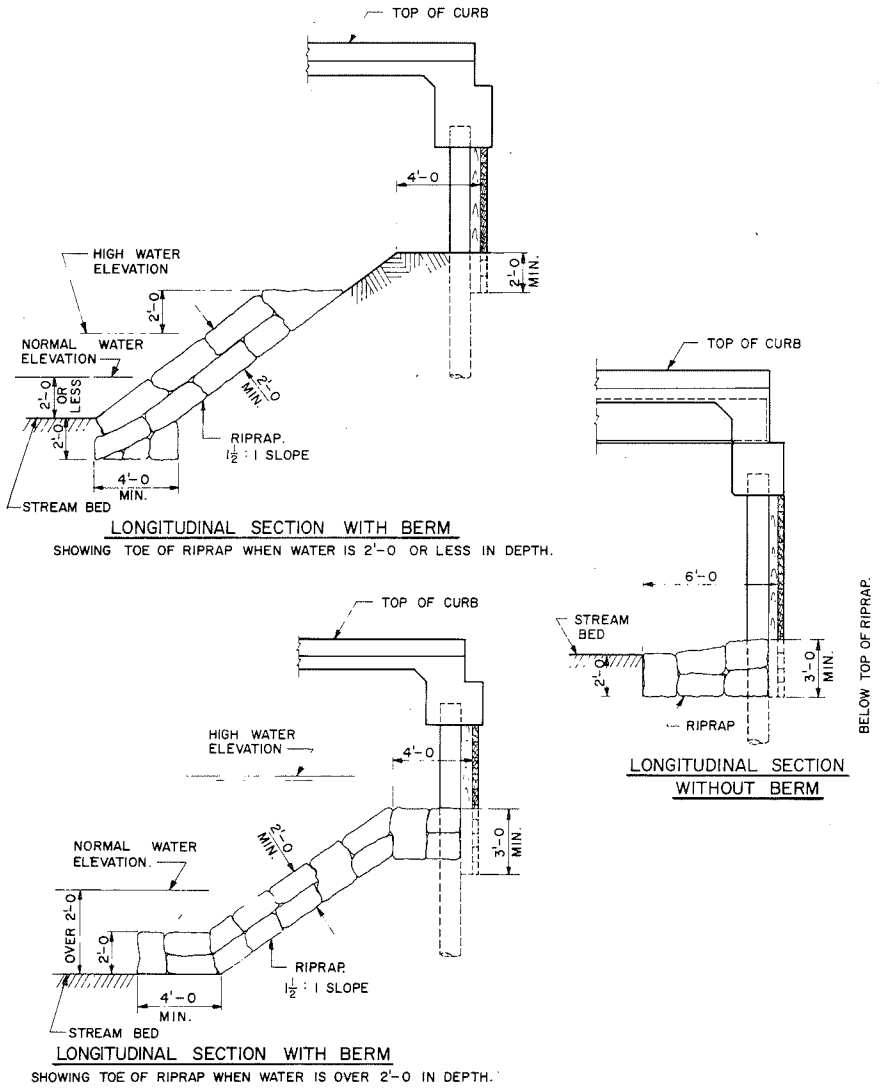

ACTIVE STREAM EROSION ZONE  
BRIDGES—TIMBER ABUTMENTS

FIGURE 2

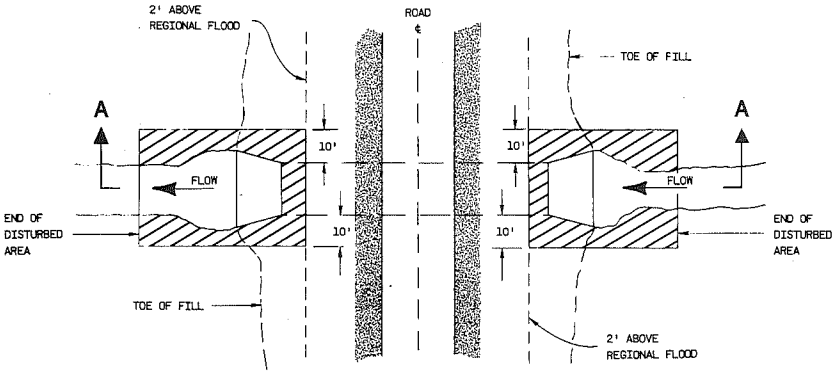

TOP VIEW

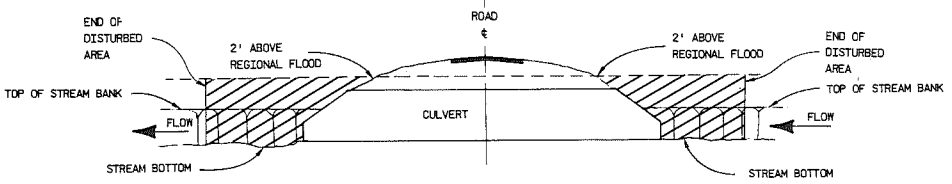

SECTION A - A

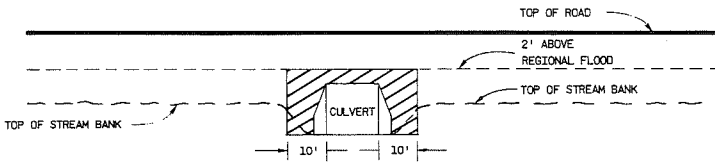

END VIEW

ACTIVE STREAM EROSION ZONE  
CULVERTS & ARCHES

FIGURE 3

Trans 207

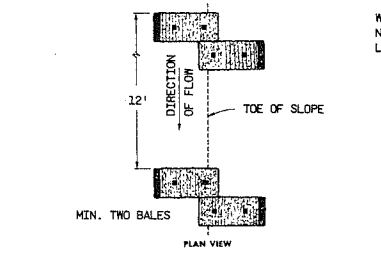

WOOD STAKES (2 PER BALE)  
 NOMINAL 2" X 2" X 30" MIN.  
 LENGTH OR EQUIVALENT

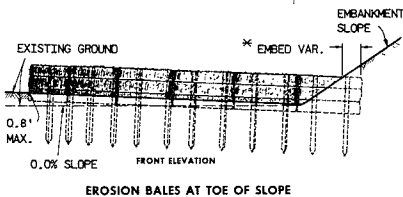
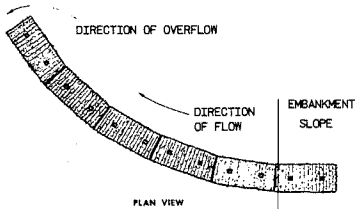
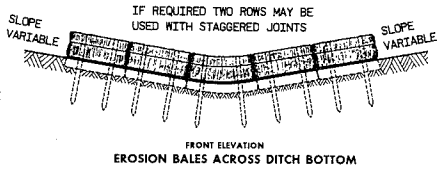
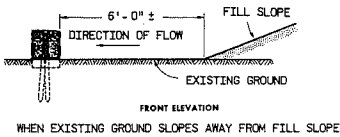
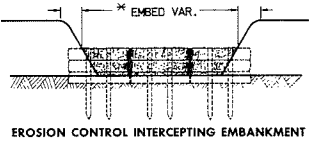
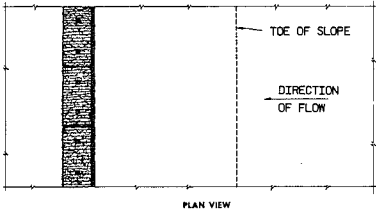
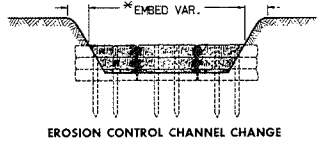
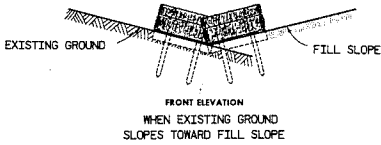
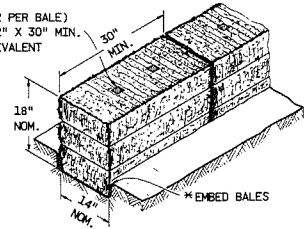

GENERAL NOTES

DETAILS OF CONSTRUCTION, MATERIALS AND WORKMANSHIP NOT SHOWN ON THIS DRAWING SHOULD CONFORM TO THE PERTINENT REQUIREMENTS OF THE STANDARD SPECIFICATIONS AND THE APPLICABLE SPECIAL PROVISIONS.

BALES SHOULD BE PLACED END TO END OR OVERLAPPING AT RIGHT ANGLES TO THE DIRECTION OF FLOW AND FAR ENOUGH UP THE SIDES OF THE DITCH TO PREVENT ERODING AROUND ENDS.

BALES SHOULD BE PLACED WITH TWINE OR TIE WIRES PARALLEL TO THE GROUND.

STAKES TO BE BATTERED IN OPPOSITE DIRECTIONS.

STAKES DRIVEN FLUSH WHEN SOIL CONDITIONS PERMIT.

\* AS DETERMINED BY THE ENGINEER.

PLACEMENT OF EROSION BALES

FIGURE 4