

Chapter Ind 22

ENERGY CONSERVATION

Part I Scope and Purpose

Ind 22.01 Scope

Ind 22.02 Purpose

Part II Definitions

Ind 22.03 Definitions

Part III Design Criteria

Ind 22.04 Indoor and outdoor temperatures

Ind 22.05 Moisture control

Part IV Building Envelope

Ind 22.06 Insulation standards

Ind 22.07 Air leakage

Part V Heating and Air Conditioning Equipment and Systems

Ind 22.08 Selection of equipment

Ind 22.09 Temperature control

Ind 22.10 Zone control

Ind 22.11 Duct and pipe insulation

Ind 22.12 Equipment efficiencies

Ind 22.13 Electronic ignition and automatic flue dampering

Part VI Buildings Utilizing Solar, Wind or Other Nondepletable Energy Sources

Ind 22.14 Innovative designs

Ind 22.15 Documentation

**PART I
SCOPE AND PURPOSE**

Ind. 22.01 Scope. The provisions of this chapter shall apply to all newly constructed conventional and manufactured one- and two-family dwellings.

Note: The energy code is not intended to apply to dwellings exclusively using a renewable source of energy, such as wood or solar heat.

Note: Chapter Ind 22 is the first of several chapters for the Uniform Dwelling Code.

History: Cr. Register, May, 1978, No. 269, eff. 12-1-78.

Ind 22.02 Purpose. (1) The purpose of this chapter is to provide design requirements which will improve the utilization of energy in one- and two-family dwellings as defined in section Ind 22.01, including minimum requirements for materials and methods of construction and for heating, cooling and air conditioning equipment and systems.

(2) The requirements of this chapter are intended to be flexible and to permit the use of innovative approaches and techniques to achieve effective utilization of energy.

(3) The requirements of this chapter are not intended to conflict with any safety or health requirements. Where such conflict occurs, the safety and health requirements shall govern.

History: Cr. Register, May, 1978, No. 269, eff. 12-1-78.

**PART II
DEFINITIONS**

Ind 22.03 Definitions. (1) **COEFFICIENT OF PERFORMANCE (COP), COOLING OR HEATING.** Coefficient of performance (COP) is the ratio of the rate of net heat removal or net heat output to the rate of total energy input, expressed in consistent units and under designated rating conditions.

(2) **COMBUSTION EFFICIENCY.** Combustion efficiency is expressed in percentage and is defined as 100% minus stack losses in percent of heat input. Stack losses are (a) loss due to sensible heat in dry flue gas, (b)

loss due to incomplete combustion, and (c) loss due to sensible and latent heat in moisture formed by combustion of hydrogen in the fuel.

(3) **COOLING LOAD.** Cooling load is the rate at which heat must be removed from the space to maintain a selected indoor air temperature during periods of design outdoor weather conditions.

(4) **DEGREE DAY, HEATING.** Degree days are figured as the number of degrees the mean outdoor temperature deviates from 65° F each day during the heating season.

Note: For example, if, on December 15, the low temperature was + 30° F and the high temperature was + 50° F, the mean temperature would equal $(30° + 50°) \div 2 = 40°$; therefore, $65° - 40° = 25$ degree days.

(5) **ENERGY EFFICIENCY RATIO.** The energy efficiency ratio is the ratio of net cooling capacity in Btu per hour to total rate of electric input, in watts, under designated operating conditions.

(6) **HEATED SPACE.** Heated space is any space provided with a supply of heat to maintain the temperature of the space to at least 50° F. Heat supplied by convection from the energy-consuming systems may satisfy this requirement in basements if the energy-consuming systems are not insulated.

(7) **HEATING LOAD.** Heating load is the probable heat loss of each room or space to be heated, based on maintaining a selected indoor air temperature during periods of design outdoor weather conditions. The total heat load includes: the transmission losses of heat transmitted through the wall, floor, ceiling, glass or other surfaces; the infiltration losses or heat required to warm outdoor air which leaks in through cracks and crevices, around doors and windows, or through open doors and windows; or heat required to warm outdoor air used for ventilation.

(8) **PERM.** Perm is the designation for the unit permeance which is a substitute for the unit, one grain per (hour) (square foot) (inch of mercury vapor pressure difference).

(9) **RESISTANCE, THERMAL (R).** Thermal resistance (R) is a measure of the ability to retard the flow of heat. The R-value is the reciprocal of a heat transfer coefficient, expressed by U ($R = 1/U$). The higher the R-value of a material, the more difficult it is for heat to flow through the material.

(10) **THERMAL TRANSMITTANCE (U).** Thermal transmittance (U) is the coefficient of heat transmission or thermal transmittance (air to air) expressed in units of Btu per (hour) (square foot) (degree F). It is the time rate of heat flow. The U-value applies to combinations of different materials used in series along the heat flow path and also to single materials that comprise a building section, and includes cavity air spaces and surface air films on both sides. The lower the U-value of a material, the more difficult it is for heat to flow through the material.

History: Cr. Register, May, 1978, No. 269, eff. 12-1-78.

PART III DESIGN CRITERIA

Ind 22.04 Indoor and outdoor temperatures. The indoor temperatures listed in Table 22.04-A and the outdoor temperatures listed in Table 22.04-B shall be used to determine the total building heat loss or heat gain and to select the size of the heating or cooling equipment.

TABLE 22.04-A
INDOOR DESIGN TEMPERATURES

Season	Temperature
Winter	70° F
Summer	78° F

History: Cr. Register, May, 1978, No. 269, eff. 12-1-78.

Ind 22.05 Moisture control. (1) **VAPOR BARRIERS.** Where thermal insulation is used, a vapor barrier shall be installed. The vapor barrier shall be installed on the interior side of the insulation, facing the heated interior, and behind the interior finish at the wall, ceiling and roof/ceiling assemblies. The vapor barrier shall cover the exposed insulation and interior face of studs, joists and rafters. Vapor barriers shall also be provided in crawl spaces, under slab floors, and around the exterior insulation installed around ducts in unheated areas. The transmission rate shall not exceed one perm.

(2) **RELATIVE HUMIDITY.** Where a power humidifier is installed, the humidifier shall be equipped with a control to regulate the relative humidity.

(3) **VENTILATION.** Ventilation above the ceiling/attic insulation shall be required. The free ventilating area shall be at least 1/300 of the horizontal area.

History: Cr. Register, May, 1978, No. 269, eff. 12-1-78.

PART IV BUILDING ENVELOPE

Ind 22.06 Insulation standards. The exterior envelope of the building shall be insulated to meet the requirements of this part. More stringent overall thermal transmittance (U_o values) will be phased in at time intervals as specified for the designated building components.

Note: If the office of state planning and energy certifies that there is a shortage of insulating materials that are routinely used in construction of one- and two-family dwellings, the department will modify the requirements of section Ind 22.06 in accordance with the available supply of insulating material, through the promulgation of an emergency rule. When the office of state planning and energy certifies that such shortages have been remedied, the department will act to reinstate the requirements of section Ind 22.06.

(1) **SLAB-ON-GRADE.** The overall thermal transmittance (U_o value) through slab-on-grade floors shall not exceed .11 Btu per (hour) (square foot) (degree F). All slab-on-grade floors located within 24 inches of the exterior grade shall be insulated. The insulation shall extend downward from the top of the slab to below the frost depth, but not less than 48

inches; or downward vertically from the top of the slab 24 inches and 24 inches horizontally under the slab.

(2) **FLOORS OVER UNHEATED AREAS.** The overall thermal transmittance (U_o value) through floors over unheated areas shall not exceed .09 Btu per (hour) (square foot) (degree F). Insulation is not required in floors over heated crawl space areas or basement areas.

(3) **WINDOWS.** All windows, except for basement windows, shall be double glazed or have storm windows.

Note: See Table A-1 of Appendix A which was developed to serve as a guide to indicate the percentage of glass which can be used for different types of wall construction.

(4) **BOX SILL.** The box sill area shall be insulated to the same level as the wall.

(5) **ROOF/CEILINGS.** The overall thermal transmittance (U_o value) through roof/ceiling assemblies shall not exceed .033 Btu per (hour) (square foot) (degree F).

Note: Section Ind 22.06 (5) will be repealed effective March 31, 1979.

(5a) **ROOF/CEILINGS** (effective April 1, 1979). The overall thermal transmittance (U_o value) through roof/ceiling assemblies shall not exceed .029 Btu per (hour) (square foot) (degree F).

(6) **EXTERIOR WALLS.** The exposed exterior walls above grade shall be insulated in accordance with (a) or (b) and (c).

(a) *Exposed exterior walls above grade.* The overall thermal transmittance (U_o value) through exposed exterior walls above grade shall not exceed .15 Btu per (hour) (square foot) (degree F).

(b) *Exterior walls above the foundation wall.* The overall thermal transmittance (U_o value) through exterior walls above the foundation wall shall not exceed .14 Btu per (hour) (square foot) (degree F).

(c) *Exposed foundation walls above grade.* The overall thermal transmittance through exposed foundation walls above grade shall not exceed the following U_o values:

1. If 25% or less of the foundation wall is exposed, $U_o = .25$ Btu per (hour) (square foot) (degree F).

2. If more than 25% of the foundation wall is exposed, the thermal transmittance of 25% of the wall shall not exceed .25 Btu per (hour) (square foot) (degree F) and the remaining exposed portion shall have a thermal transmittance of not more than .14 Btu per (hour) (square foot) (degree F).

Note: Section Ind 22.06 (6) will be repealed effective March 31, 1979.

(6a) **EXTERIOR WALLS** (effective April 1, 1979). The exposed exterior walls above grade shall be insulated in accordance with (a) or (b) and (c).

**TABLE 22.04-B
OUTDOOR DESIGN CONDITIONS**

Zone	Winter	Summer
	Design Temp. (°F)	Dry Bulb (°F)
1	-25	86
2	-20	87
3	-15	87
4	-10	89

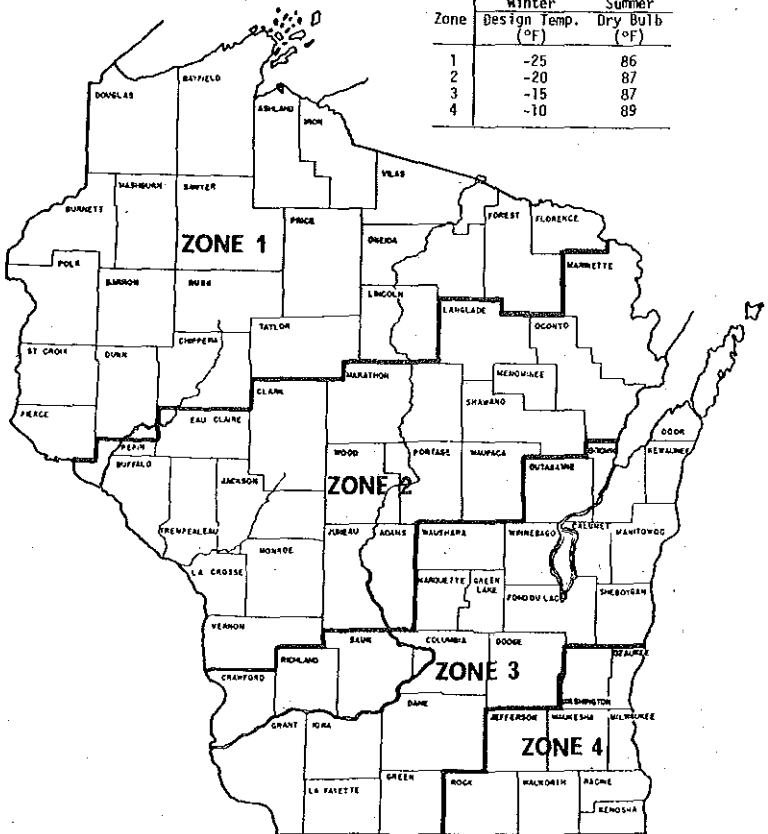

(a) *Exposed exterior walls above grade.* The overall thermal transmittance (U_o value) through exposed exterior walls above grade shall not exceed .14 Btu per (hour) (square foot) (degree F).

(b) *Exterior walls above foundation wall.* The overall thermal transmittance (U_o value) through exterior walls above the foundation wall shall not exceed .13 Btu per (hour) (square foot) (degree F).

(c) *Exposed foundation walls above grade.* The overall thermal transmittance through exposed foundation walls above grade shall not exceed the following U_o values:

1. If 25% or less of the foundation wall is exposed, $U_o = .25$ Btu per (hour) (square foot) (degree F).

2. If more than 25% of the foundation wall is exposed, the thermal transmittance of 25% of the wall shall not exceed .25 Btu per (hour) (square foot) (degree F) and the remaining exposed portion shall have a thermal transmittance of not more than .13 Btu per (hour) (square foot) (degree F).

Note: Section Ind 22.06 (6a) will be repealed effective March 31, 1980.

(6b) **EXTERIOR WALLS** (effective April 1, 1980). The exposed exterior walls above grade shall be insulated in accordance with (a) or (b) and (c).

(a) *Exposed exterior walls above grade.* The overall thermal transmittance (U_o value) through exposed exterior walls above grade shall not exceed .13 Btu per (hour) (square foot) (degree F).

(b) *Exterior walls above the foundation wall.* The overall thermal transmittance (U_o value) through exterior walls above the foundation wall shall not exceed .12 Btu per (hour) (square foot) (degree F).

(c) *Exposed foundation walls above grade.* The overall thermal transmittance exposed foundation walls above grade shall not exceed the following U_o values:

1. If 25% or less of the foundation wall is exposed, $U_o = .25$ Btu per (hour) (square foot) (degree F).

2. If more than 25% of the foundation wall is exposed, the thermal transmittance of 25% of the wall shall not exceed .25 Btu per (hour) (square foot) (degree F) and the remaining exposed portion shall have a thermal transmittance of not more than .12 Btu per (hour) (square foot) (degree F).

(7) **ELECTRICAL BOXES.** Insulation shall be provided behind electrical boxes located in exterior walls.

(8) **BELOW GRADE FOUNDATION INSULATION** (effective April 1, 1979). A thermal transmittance (U_o value) of .20 Btu per (hour) (square foot) (degree F) shall be required for below grade foundation walls to a level of 3 feet below grade or to the top of the footing.

(9) **SYSTEM DESIGN.** The overall transmission of heat (U value) through any one component (such as wall, roof/ceiling or floor) may be increased and the U -value for other components decreased provided

that the overall heat loss for the entire building enclosure does not exceed the total heat loss resulting from complying with (1) through (8) of this section.

Note: See Appendix A for an example of the system design procedure.

(10) **ACCURACY OF CALCULATIONS.** The thermal transmittance (U_o) values and building dimensions used in heat gain or loss calculations shall have a minimum decimal accuracy of 3 places rounded to 2, except that the U_o values used for calculating ceiling transmission shall have a minimum decimal accuracy of 4 places rounded to 3.

History: Cr. Register, May, 1978, No. 269, eff. 12-1-78.

Ind 22.07 Air leakage. (1) **GENERAL.** All windows and doors shall be constructed and installed to minimize air leakage.

(2) **DOORS AND WINDOWS.** Manufactured windows shall be constructed and installed to limit infiltration to .5 cubic feet per minute per foot of sash crack. The air infiltration rate of sliding glass doors shall not exceed .5 cubic feet per minute per square foot of door area. The air infiltration rate for swinging doors shall not exceed 1.25 cubic feet per minute per square foot of door area.

Note: The department will recognize windows and doors tested in conformance with ASTM E-283, Standard Method of Test for Rate of Air Leakage Through Exterior Curtain Walls and Doors.

(3) **EXTERIOR OPENINGS.** Exterior joints around windows and door frames; between wall cavities and window or door frames; between walls and foundations; between walls and roofs; between walls and floors; between separate wall panels; at penetrations of utility services through walls, floors and roofs; and all other openings in the exterior building envelope shall be caulked, gasketed, weatherstripped or otherwise sealed.

(4) **INTERIOR OPENINGS.** Openings through the top plate of frame walls shall be caulked, gasketed, packed with insulation, or otherwise sealed.

History: Cr. Register, May, 1978, No. 269, eff. 12-1-78.

PART V HEATING AND AIR CONDITIONING EQUIPMENT AND SYSTEMS

Ind 22.08 Selection of equipment. The output capacity of the mechanical heating, cooling and air conditioning equipment shall not exceed the calculated heating load and cooling load by more than 15%, except to satisfy the next closest manufacturer's nominal size.

History: Cr. Register, May, 1978, No. 269, eff. 12-1-78.

Ind 22.09 Temperature control. At least one thermostat for regulating the temperature of the space shall be provided for each separate system. Thermostats used to control the heating system may also be used to control the cooling system.

Note: Setting back the thermostat during periods of non-use or thermostats equipped with automatic controls which reduce the temperature during periods of non-use, conserve energy.

History: Cr. Register, May, 1978, No. 269, eff. 12-1-78.

Ind 22.10 Zone control. Each heating and cooling system shall be provided with an automatic or manually controlled damper or valve to shut off or reduce the heating or cooling to each zone or floor and to each room.

History: Cr. Register, May, 1978, No. 269, eff. 12-1-78.

Ind 22.11 Duct and pipe insulation. (1) **DUCT INSULATION.** All duct systems exposed to unheated spaces shall be insulated with materials having a minimum thermal resistance of $R = 5$.

(2) **PIPE INSULATION.** All heating pipes in unheated spaces and all cooling pipes in conditioned spaces shall be insulated with at least one inch of insulation. A vapor barrier on the exposed side of the insulation shall be provided on cooling pipes to prevent condensation. Pipes installed within heating and air conditioning equipment, installed in conditioned spaces, are not required to be insulated.

History: Cr. Register, May, 1978, No. 269, eff. 12-1-78.

Ind 22.12 Equipment efficiencies. (1) **ELECTRICAL EQUIPMENT.** (a) *Air conditioning equipment.* Air conditioning equipment shall have a minimum energy efficiency ratio (EER) of 6.1 (COP of 1.8).

(b) *Heat pumps.* Heat pumps shall comply with the minimum coefficients of performance set forth in Table 22.12.

TABLE 22.12
MINIMUM COP FOR HEAT PUMPS, HEATING MODE

Source and outdoor temperature (°F)	Minimum COP
Air source - 47 dry bulb/43 wet bulb	2.2
Air source - 17 dry bulb/15 wet bulb	1.2
Water source - 60 entering	2.2

1. The heat pump shall be installed with a control to prevent the supplementary heater from operating when the heating load can be more efficiently satisfied by the heat pump alone.

2. Supplementary heater operation is permitted during transient periods, such as start-ups, following room thermostat set point advance, and during defrost.

Note: A two-stage room thermostat, which controls the supplementary heat on its second stage, will be accepted as meeting this requirement. The cut-on temperature for the compression heating should be higher than the cut-on temperature for the supplementary heat; the cut-off temperature for the compression heating should be higher than the cut-off temperature for the supplementary heat.

(2) **COMBUSTION HEATING EQUIPMENT.** All gas-fired and oil-fired heating equipment shall have a minimum combustion efficiency of 75% at maximum rated output.

History: Cr. Register, May, 1978, No. 269, eff. 12-1-78.

Ind 22.13 Electronic ignition and automatic flue dampering (effective April 1, 1979). Combustion space-heating equipment shall be provided with electronic ignition and automatic flue dampering, except

Register, May, 1978, No. 269
Energy Conservation

sealed combustion equipment or equipment located in enclosures and provided with combustion air need not be provided with automatic flue dampering.

History: Cr. Register, May, 1978, No. 269, eff. 12-1-78.

**PART VI
BUILDINGS UTILIZING SOLAR, WIND OR OTHER
NONDEPLETABLE ENERGY SOURCES**

Ind 22.14 Innovative designs. (1) **DESIGNS UTILIZING NONDEPLETABLE ENERGY SOURCES.** Any innovative building or system design, or a design which utilizes solar, geothermal, wind or other nondepletable energy sources will be accepted by the department provided the design utilizes less depletable energy than determined through the accepted practice method or the system design method.

(2) **OTHER ALTERNATIVE DESIGNS.** Proposed alternative designs may also consider energy savings resulting from orientation of the building on the site; the geometric shape of the building; the aspect ratio (ratio of length to width); the number of stories for a given floor area; the thermal mass of the building; the exterior surface color; shading or reflections from adjacent structures; surrounding surfaces of vegetation; natural ventilation; and wind direction and speed.

History: Cr. Register, May, 1978, No. 269, eff. 12-1-78.

Ind 22.15 Documentation. Proposed alternative designs shall be accompanied with an energy analysis comparing the energy utilized by the proposed design with the energy used by a design complying with Part IV.

History: Cr. Register, May, 1978, No. 269, eff. 12-1-78.

APPENDIX A

DETERMINING THE LEVEL OF INSULATION

Two methods are outlined for determining the level of insulation required by section Ind 22.06 using the following sample dwelling:

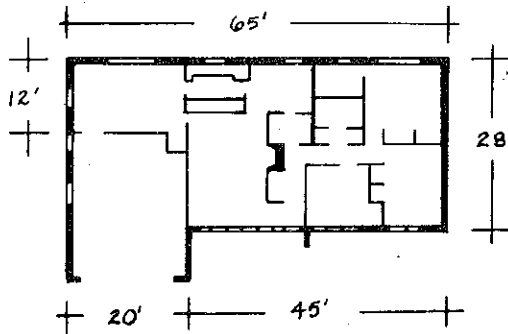

Sample dwelling: 1,500 square feet (186 lineal feet)

Gross wall area = 8.13' x 186 lineal feet = 1,512.18 square feet
 Opaque wall area = 1,301.69 square feet (20% framing, 80% cavity)
 Box sill area = .81' x 186 lineal feet = 150.66 square feet
 Exposed foundation wall area = 108.97 square feet
 Basement window area = 15.65 square feet
 Insulated window area = 172.67 square feet
 Insulated door area = 37.82 square feet
 Ceiling area = 1,500 square feet (10% framing, 90% cavity)

DEPT. OF INDUSTRY, LABOR & HUMAN RELATIONS 11

METHOD I - ACCEPTABLE PRACTICE METHOD

The acceptable practice method outlined below can be used with minimum calculations for determining the acceptable level of insulation.

Problem: Using the acceptable practice method determine the level of insulation required for the 1,500 square foot dwelling in Phase I.

Step 1: Determine the percentage window and door area.

$$\begin{aligned} \text{Percent opening area} &= \frac{\text{Window area} + \text{Door area}}{\text{Gross wall area} + \text{Box sill area}} \times 100\% \\ &= \frac{172.67 \text{ sq. ft.} + 37.82 \text{ sq. ft.}}{1512.18 \text{ sq. ft.} + 150.66 \text{ sq. ft.}} \times 100\% \\ &= \frac{210.49 \text{ sq. ft.}}{1,662.84 \text{ sq. ft.}} \times 100\% = 12.66\% \end{aligned}$$

Step 2: Determine level of insulation required for the box sill and sidewalls for the given window and door area from Table A-1. (Phase 1)

Using 5/8 inch plywood siding the table shows that an R-11 batt with R-1.22 fiberboard will allow up to 12.8% window and door area.

Step 3: Determine the percentage window area for the exposed foundation wall.

$$\begin{aligned} \text{Percent opening area} &= \frac{\text{Window area}}{\text{Total exposed foundation area}} \times 100\% \\ &= \frac{15.65 \text{ sq. ft.}}{108.97 \text{ sq. ft.} + 15.65 \text{ sq. ft.}} \times 100\% \\ &= 12.6\% \end{aligned}$$

Step 4: Determine the amount of exposed foundation wall:

If there is 8" of wall exposed and the wall height is 8',

$$\text{Percent exposed wall} = \frac{8'' / (12'' \text{ per foot})}{8'} \times 100\% = 8.3\%$$

Step 5: Refer to Table A-2 to determine the level of insulation required for the foundation.

Using the requirements for less than 25% exposed foundation wall the table shows that an R-5.27 insulation can be used for up to 24.8% double glazed windows.

Step 6: Select the level of insulation required for the ceiling from Table A-3.

TABLE A-1
WALL INSULATION GUIDE
(Based on U_o requirements above the foundation wall)

Insulation Type	Percent Window and Door Area					
	Phase I		Phase II (4/1/79)		Phase III (4/1/80)	
	$U_o = .14$		$U_o = .13$		$U_o = .12$	
	5/8-inch Plywood Siding	Backed Aluminum Siding	5/8-inch Plywood Siding	Backed Aluminum Siding	5/8-inch Plywood Siding	Backed Aluminum Siding
R-11 Batt	11.0	12.6	8.9	10.5	6.8	8.4
R-11 Batt, R-1.22 Fiberboard	12.8	14.0	10.8	12.0	8.7	9.9
R-11 Batt, R-5.27 Rigid Insulation Board	16.4	17.0	14.4	15.0	12.4	13.0
R-11 Batt, R-10.54 Rigid Insulation Board	18.8	19.1	16.8	17.2	14.9	15.3
R-13 Batt	12.5	13.9	10.4	11.8	8.3	9.8
R-13 Batt, R-1.22 Fiberboard	14.1	15.4	12.2	13.3	10.3	11.2
R-13 Batt, R-5.27 Rigid Insulation Board	17.0	17.5	15.0	15.6	13.1	13.6
R-13 Batt, R-10.54 Rigid Insulation Board	19.2	19.5	17.3	17.6	15.3	15.6
R-19 Batt	15.3	16.2	13.2	14.2	11.2	12.2
R-19 Batt, R-1.22 Fiberboard	16.4	17.1	14.4	15.1	12.3	13.1
R-19 Batt, R-5.27 Rigid Insulation Board	18.6	19.0	16.7	17.0	14.7	15.1
R-19 Batt, R-10.54 Rigid Insulation Board	20.1	20.4	18.2	18.5	16.3	16.6

Note: The following assumptions are used:

1. Door area = 2% of wall and box sill area.
2. Insulated doors with a U-value of .47.
3. Insulated windows with a U-value of .56.
4. The insulation type is carried down through the box sill.

TABLE A-2
EXPOSED FOUNDATION INSULATION

Foundation exposure	Requirement	Insulation type	Percent window area	
			Single glazed	Double glazed
Less than 25% of foundation exposed	$U_o = .25$	R-5.27	10.4	24.8
		R-11 batt	15.5	34.2
		Multi-cell insul. block (R-12.06)	16.0	35.0
More than 25% of foundation exposed	$U_o = .14$	R-11 batt	4.9	10.8
		R-13 batt	5.8	12.7
		Multi-cell insul. block (R-12.06)	5.5	12.0
	$U_o = .13$	R-11 batt	3.9	8.7
		R-13 batt	4.8	10.6
		Multi-cell insul. block (R-12.06)	4.5	9.9
	$U_o = .12$	R-11 batt	3.0	6.7
		R-13 batt	3.9	8.5
		Multi-cell insul. block (R-12.06)	3.5	7.8

TABLE A-3
INSULATION LEVELS REQUIRED TO MEET CEILING U VALUES

U ₀ Value	Insulation	R-Value Required	
		In Cavity	Over Framing
.033	Fiber glass batt	R-19 and R-13	R-13
	Fiber glass blown	12 in. (R-30)	6.4 in. (R-16)
	Rock wool	9.7 in. (R-29)	4.2 in. (R-13)
	Cellulose	8.4 in. (R-31)	2.9 in. (R-11)
.029	Fiber glass batt	R-38	R-19
	Fiber glass blown	13.6 in. (R-34)	8.1 in. (R-20)
	Rock wool	10.9 in. (R-33)	5.4 in. (R-16)
	Cellulose	9.5 in. (R-35)	4.0 in. (R-15)

Note: The following assumptions are used:

1. Fiber glass blown = R-2.5 per inch
2. Rock wool = R-3.0 per inch
3. Cellulose = R-3.7 per inch

METHOD II - SYSTEM DESIGN METHOD

The system design method is the more complex method of determining the level of insulation required by the code. This procedure may be used when it becomes necessary to combine various materials to comply with the code. If the window area is increased and the same wall insulation is used, the wall section will not meet the requirements of section Ind 22.06 (6), but the system design method can be used by adding extra insulation elsewhere.

Problem: Using the system design method, increase the opening area to 15% and determine compliance by adding extra insulation to the walls and ceiling.

Step 1: Determine the inside and outside design temperatures from Tables 22.04-A and B.

$$\begin{aligned} \text{Inside temperature} &= 70^\circ \text{ F} \\ \text{Outside temperature} &= -20^\circ \text{ F} \\ \nabla T &= T_{\text{inside}} - T_{\text{outside}} = 70 - (-20) = 90^\circ \text{ F.} \end{aligned}$$

Note: Degree days may be used for system design instead of design temperatures:

Zone 1, 9,000 degree days
 Zone 2, 8,000 degree days
 Zone 3, 7,500 degree days
 Zone 4, 7,000 degree days

Step 2: Using section Ind 22.06, determine the insulation values for the exterior walls above grade and the roof/ceiling for Phase I.

Exposed exterior walls above grade; $U_o = .15$
 Roof/ceiling; $U_o = .033$

Step 4: Fill in the worksheet to determine requirements for building enclosure heat loss.

Step 5: Select the levels of insulation to be used and determine the U values for the ceiling, wall, box sill and foundation (shown in Figure A-1). Fill in the building enclosure worksheet.

Step 6: If the total heat loss determined through the system design method is within one percent or is less than the heat loss determined through the code requirements, the code has been satisfied.

R-VALUE DETERMINATION BY COMPONENT

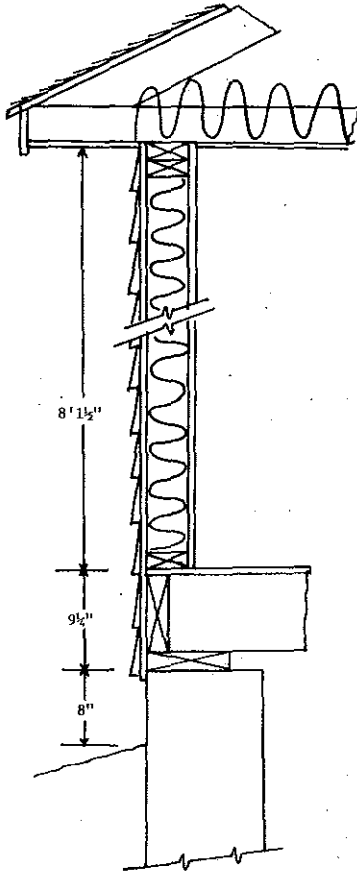

Figure A-1

Ceiling	Cavity R	Joist R
Top surface	.17	.17
Insulation	38.0	19.00
Wood	--	6.88
1/2" gyp. wall board	.45	.45
Bottom surface	.61	.61
	<u>39.23</u>	<u>27.11</u>
	(U=.025)	(U=.037)

Wall	Cavity R	Stud R
Outside surface	.17	.17
5/8" ext. siding	.77	.77
Rigid insulation	--	--
Insulation	11.00	--
Wood stud	--	4.38
1/2" gyp. wall board	.45	.45
Inside surface	.68	.68
	<u>13.07</u>	<u>6.45</u>
	(U=.070)	(U=.13)

Box sill	R
Outside surface	.17
5/8" ext. siding	.77
Rigid insulation	--
Insulation	11.00
1-1/2" wood	1.88
Inside surface	.68
	<u>14.50</u>
	(U=.064)

Foundation	R
Outside surface	.17
8" concrete	.64
Inside surface	.68
Rigid insulation	5.27
	<u>6.76</u>
	(U=.15)

DEPT. OF INDUSTRY, LABOR & HUMAN RELATIONS 17

WORKSHEET FOR SYSTEM DESIGN ANALYSIS

CODE REQUIREMENTS				
Component	U _o Req'd.	Area	ΔT	Heat Loss
Walls				
Above grade	.15	1512.18	90	20,414.4
Box Sill	.15	150.66	70	1,581.9
Foundation	.15	124.62	70	1,308.5
Roof/Ceiling	.033	1500.00	90	4,455.0
Floor				
Over unheated spaces				
Slab-on-grade				
TOTAL				27,759.9

SYSTEM DESIGN ALTERNATIVE				
Component	U	Area	ΔT	Heat Loss
Walls				
Cavity	.070	1010.20	90	6,364.3
Solid	.13	252.60	90	2,955.4
Box sill	.064	150.66	70	675.0
Foundation	.15	108.97	70	1,114.2
Roof/Ceiling				
Cavity	.025	1350.00	90	3,037.5
Solid	.037	150.00	90	499.5
Floor				
Over unheated spaces				
Slab-on-grade				
Windows	.56	211.61	90	10,665.1
Doors	.31	37.82	90	1,055.2
Basement windows	1.13	15.65	70	1,237.9
TOTAL				27,634.1

WORKSHEET FOR SYSTEM DESIGN ANALYSIS

CODE REQUIREMENTS				
Component	U _o Req.	Area	ΔT	Heat Loss
Walls				
Above grade				
Box sill				
Foundation				
Roof/Ceiling				
Floor				
Over unheated spaces				
Slab-on-grade				
TOTAL				_____

SYSTEM DESIGN ALTERNATIVE				
Component	U	Area	ΔT	Heat Loss
Walls				
Cavity				
Solid				
Box sill				
Foundation				
Roof/Ceiling				
Cavity				
Solid				
Floor				
Over unheated spaces				
Slab-on-grade				
Windows				
Doors				
Basement windows				
TOTAL				_____

DEPT. OF INDUSTRY, LABOR & HUMAN RELATIONS 19

TABLE A-4
COMMON CONSTRUCTION MATERIAL R-VALUES*

Material	Description	Density (lb per cu ft)	Per inch	For thick-	
			thickness R-Value	ness listed R-Value	
BUILDING BOARD Boards, panels, subflooring, sheathing, woodbased panel products	Asbestos-cement board.....	120	0.25	--	
	Asbestos-cement board....1/8 in.	120	--	0.03	
	Asbestos-cement board....1/4 in.	120	--	0.06	
	Gypsum or plaster board...3/8 in.	50	--	0.32	
	Gypsum or plaster board...1/2 in.	50	--	0.45	
	Plywood.....	34	1.25	--	
	Plywood.....1/4 in.	34	--	0.31	
	Plywood.....3/8 in.	34	--	0.47	
	Plywood.....1/2 in.	34	--	0.62	
	Plywood or wood panels...3/4 in.	34	--	0.93	
	Insulating board				
	Sheathing, reg. density...1/2 in.	18	--	1.32	
25/32 in.	18	--	2.06	
	Sheathing, intermediate				
	density.....1/2 in.	22	--	1.22	
	Nail-base sheathing....1/2 in.	25	--	1.14	
	Shingle backer.....3/8 in.	18	--	0.94	
	Shingle backer.....5/16 in.	18	--	0.78	
	Sound deadening board...1/2 in.	15	--	1.35	
	Tile and lay-in panels, plain or acoustic.....	18	2.50	--	
1/2 in.	18	--	1.25	
3/4 in.	18	--	1.89	
	Laminated paperboard.....	30	2.00	--	
	Homogeneous board from re pulped paper.....	30	2.00	--	
	Hardboard				
	Medium density siding...7/16 in.	40	--	0.67	
	Other medium density.....	50	1.37	--	
	High density, underlay.....	55	1.22	--	
	High density std. tempered....	63	1.00	--	
	Particleboard				
Low density.....	37	1.85	--		
Medium density.....	50	1.06	--		
High density.....	62.5	0.85	--		
Underlayment.....5/8 in.	40	--	0.82		
Wood subfloor.....3/4 in.	--	--	0.94		
BUILDING PAPER	Vapor-permeable felt.....	--	--	0.06	
	Vapor-seal, 2 layers of mopped 15 lb. felt.....	--	--	0.12	
	Vapor-seal, plastic film.....	--	--	Negl.	
ROOF INSULATION	Preformed, for use above deck				
	Approximately.....1/2 in.	--	--	1.39	
	Approximately.....1 in.	--	--	2.78	
	Approximately.....1-1/2 in.	--	--	4.17	
	Approximately.....2 in.	--	--	5.56	
	Approximately.....2-1/2 in.	--	--	6.67	
	Approximately.....3 in.	--	--	8.33	
Cellular glass.....	9	2.50	--		

Material	Description	Density (lb per cu ft)	Per inch	For thick-	
			thickness. R-Value	ness listed R-Value	
MASONRY MATERIALS Concrete	Cement mortar.....	116	0.20	--	
	Gypsum-fiber concrete 87% gypsum, 12% wood chips...	51	0.60	--	
	Lightweight aggregates including expanded shale, clay or slate, expanded slags; cinders; pumice; vermiculite; also cellular concretes	120 100 80 60 40 30 20	0.19 0.28 0.40 0.59 0.86 1.11 1.43	-- -- -- -- -- -- --	
	Perlite.....	40 30 20	1.08 1.41 2.00	-- -- --	
	Sand and gravel or stone aggregate (oven dried).....	140	0.11	--	
	Sand and gravel or stone aggregate (not dried).....	140	0.08	--	
	Stucco.....	116	0.20	--	
	MASONRY UNITS	Brick, common.....	120	0.20	--
		Brick, face.....	130	0.1F	--
		Clay tile, hollow:			
		1 cell deep.....3 in.	--	--	0.80
		1 cell deep.....4 in.	--	--	1.11
		2 cells deep.....6 in.	--	--	1.52
2 cells deep.....8 in.		--	--	1.85	
2 cells deep.....10 in.		--	--	2.22	
3 cells deep.....12 in.		--	--	2.50	
Concrete blocks, 3 oval cores:					
Sand & gravel aggregate...4 in.		--	--	0.71	
.....8 in.		--	--	1.11	
.....12 in.		--	--	1.28	
Cinder aggregate.....3 in.		--	--	0.86	
.....4 in.		--	--	1.11	
.....8 in.		--	--	1.72	
.....12 in.		--	--	1.89	
Lightweight aggregate.....3 in.		--	--	1.27	
(expanded shale, clay,....4 in.		--	--	1.50	
slate or slag; pumice)....8 in.		--	--	2.00	
.....12 in.		--	--	2.27	
Concrete blocks, rectangular core					
Sand & gravel aggregate					
2 core, 8" 36 lb.....	--	--	1.04		
Same with filled cores.....	--	--	1.93		
Lightweight aggregate (expanded shale, clay, slate or slag, pumice):					
3 core, 6" 19 lb.....	--	--	1.65		
Same with filled cores.....	--	--	2.99		
2 core, 8" 24 lb.....	--	--	2.18		
Same with filled cores.....	--	--	5.03		
3 core, 12" 38 lb.....	--	--	2.48		
Same with filled cores.....	--	--	5.82		
Stone, lime or sand.....	--	0.08	--		

DEPT. OF INDUSTRY, LABOR & HUMAN RELATIONS 21

Material	Description	Density (lb per cu ft)	Per inch thickness R-Value	For thick- ness listed R-Value
MASONRY UNITS (Continued)	Gypsum partition tile:			
	3 x 12 x 30 in. solid.....	--	--	1.26
	3 x 12 x 30 in. 4-cell.....	--	--	1.35
	4 x 12 x 30 in. 3-cell.....	--	--	1.67
PLASTERING MATERIALS	Cement plaster, sand aggregate..	116	0.20	--
	Sand aggregate.....3/4 in.	--	--	0.08
	Sand aggregate.....3/4 in.	--	--	0.15
	Gypsum plaster:			
	Lightweight aggregate...1/2 in.	45	--	0.32
	Lightweight aggregate...5/8 in.	45	--	0.39
	Lightweight aggregate on metal lath.....3/4 in.	--	--	0.47
	Perlite aggregate.....	45	0.67	--
	Sand aggregate.....	105	0.18	--
	Sand aggregate.....1/2 in.	105	--	0.09
	Sand aggregate.....5/8 in.	105	--	0.11
	Sand aggregate on metal lath.....3/4 in.	--	--	0.1
	Vermiculite aggregate.....	45	0.59	--
ROOFING	Asbestos-cement shingles.....	120	--	0.21
	Asphalt roll roofing.....	70	--	0.15
	Asphalt shingles.....	70	--	0.44
	Built-up roofing.....3/8 in.	70	--	0.33
	Slate.....1/2 in.	--	--	0.05
	Wood shingles, plain plastic film faced.....	--	--	0.94
	SIDING MATERIALS (On flat surface)	Shingles:		
Asbestos-cement.....		120	--	0.21
Wood, 16", 7 1/2" exposure.....		--	--	0.87
Wood, double, 16", 12" exposure		--	--	1.19
Wood, plus insulating backer board.....5/16 in.		--	--	1.40
Siding:				
Asbestos-cement, 1/2" lapped....		--	--	0.21
Asphalt roll siding.....		--	--	0.15
Asphalt insulating siding (1/2" bd.).....		--	--	1.46
Wood drop 1 x 8".....		--	--	0.79
Wood bevel, 1/2 x 8" lapped.....		--	--	0.81
Wood bevel, 3/4 x 10" lapped....		--	--	1.05
Wood plywood 3/8" lapped.....		--	--	0.59
Aluminum or steel, over sheath- ing, hollow-backed.....		--	--	0.61
Insulating-board backed nominal 3/8".....		--	--	1.82
Insulating-board backed nominal 3/8" foil backed.....		--	--	2.96
Architectural glass.....		--	--	0.10

WISCONSIN ADMINISTRATIVE CODE

Material	Description	Density	Per inch	For thick-
		(lb per cu ft)	thickness R-Value	ness listed R-Value
FINISH FLOORING MATERIALS	Carpet and fibrous pad.....	---	---	2.08
	Carpet and rubber pad.....	---	---	1.23
	Cork tile.....1/8 in.	---	---	0.28
	Terrazzo.....1 in.	---	---	0.08
	Tile-asphalt, linoleum, vinyl, rubber.....	---	---	0.05
	Wood, hardwood finish....3/4 in.	---	---	0.08
INSULATING MATERIALS Blanket and Batt	Mineral fiber, fibrous form processed from rock, slag or glass			
	Approx. 2 to 2-3/4".....Note 1	---	---	7
	Approx. 3 to 3-1/2".....Note 1	---	---	11
	Approx. 5-1/4 to 6-1/2".....Note 1	---	---	19
Board and Slabs	Cellular glass.....	9	2.50	---
	Glass fiber, organic bonded.....	4-9	4.00	---
	Expanded rubber (rigid).....	4.5	4.55	---
	Expanded polystyrene extruded, plain.....	1.8	4.00	---
	Expanded polystyrene extruded (R-12 exp.).....	2.2	5.00	---
	Expanded polystyrene extruded (R-12 exp.) (Thickness 1" and greater).....	3.5	5.26	---
	Expanded polystyrene, molded beads.....	1.0	3.57	---
	Expanded polyurethane (R-11 exp)	1.5	6.25	---
	Mineral fiber with resin binder.	15	3.45	---
	Mineral fiberboard wet felted			
	Core or roof insulation.....	16-17	2.94	---
	Acoustical tile.....	18	2.86	---
	Acoustical tile.....	21	2.70	---
	Mineral fiberboard wet molded			
	Acoustical tile.....	23	2.38	---
	Wood or cane fiberboard			
	Acoustical tile.....1/2 in.	---	---	1.25
	Acoustical tile.....3/4 in.	---	---	1.89
	Interior finish (plank, tile)...	15	2.86	---
	Insulating roof deck			
Approximately.....1-1/2 in.	---	---	4.17	
Approximately.....2 in.	---	---	5.56	
Approximately.....3 in.	---	---	8.33	
Wood shredded (cemented in preformed slabs).....	22	1.67	---	
Loose Fill	Cellulose insulation (milled paper or wood pulp).....	2.5-3	3.70	---
	Sawdust or shavings.....	0.8-1.5	2.22	---
	Wood fiber, softwoods.....	2.0-3.5	3.33	---
	Perlite, expanded.....	5.0-8.0	2.70	---

Material	Description	Density (lb per cu ft)	Per inch	For thick-
			thickness	ness listed
		R-Value		R-Value
Loose Fill (Continued)	Mineral fiber (rock, slag or glass:			
	Approximately 3".....Note 1	8-15	--	9
	Approximately 4-1/2".....Note 1	8-15	--	13
	Approximately 6-1/4".....Note 1	8-15	--	19
	Approximately 7-1/4".....Note 1	8-15	--	24
	Silica aerogel.....	7.6	5.88	--
	Vermiculite (expanded).....	7.0-8.2	2.13	--
		4.0-6.0	2.27	--
WOODS	Maples, oak and similar hardwoods.....	45	0.91	--
	Fir, pine, and similar softwoods.....	32	1.25	--
	Fir, pine, and similar softwoods.....3/4 in.	32	--	0.94
1-1/2 in.	32	--	1.89
2-1/2 in.	32	--	3.12
3-1/2 in.	32	--	4.35

Note 1: R-value varies with fiber diameter. Insulation is produced by different densities; therefore, there is a wide variation in thickness for the same R-value between various manufacturers. (See Batt and Loose Fill Insulation.)

*Reprinted with permission from ASHRAE Handbook of Fundamentals 1972.

TABLE A-5
 COEFFICIENTS OF TRANSMISSION (U) OF WINDOWS, SKYLIGHTS, AND LIGHT TRANSMITTING PARTITIONS*
 (These values are for heat transfer from air to air.)
 Btu per (hr) (sq ft) (F Deg)

PART A VERTICAL PANELS (EXTERIOR WINDOWS, SLIDING PATIO DOORS AND PARTITIONS)--FLAT GLASS, GLASS BLOCK AND PLASTIC SHEET				PART B HORIZONTAL PANELS (SKYLIGHTS) FLAT GLASS, GLASS BLOCK AND PLASTIC BUBBLES			
Description	Exterior ¹		Interior	Description	Exterior ¹		Interior ⁵
	Winter ²	Summer			Winter ²	Summer ²	
Flat Glass				Flat Glass			
single glass	1.13	1.06	0.73	single glass	1.22	0.83	0.96
insulating glass--double ²				insulating glass--double ²			
3/16 in. air space	0.69	0.64	0.51	3/16 in. air space	0.75	0.49	0.62
1/4 in. air space	0.65	0.61	0.49	1/4 in. air space	0.70	0.46	0.59
1/2 in. air space	0.58	0.56	0.46	1/2 in. air space	0.66	0.44	0.56
1/2 in. air space, low emissivity coating ³				1/2 in. air space, low emissivity coating ³			
emissivity = 0.20	0.38	0.36	0.32	emissivity = 0.20	0.46	0.31	0.39
emissivity = 0.40	0.45	0.44	0.38	emissivity = 0.40	0.53	0.36	0.45
emissivity = 0.60	0.52	0.50	0.42	emissivity = 0.60	0.60	0.40	0.50
insulating glass--triple ²				Glass Block ⁴			
1/4 in. air spaces	0.47	0.45	0.38	11 x 11 x 3 in. thick with cavity divider	0.53	0.35	0.44
1/2 in. air spaces	0.36	0.35	0.30	12 x 12 x 4 in. thick with cavity divider	0.51	0.34	0.42
storm windows				Plastic Bubbles ⁷			
1 in.-4 in. air space	0.56	0.54	0.44	single walled	1.15	0.80	--
Glass Block ⁴				double walled	0.70	0.46	--
6 x 6 x 4 in. thick	0.60	0.57	0.46				
8 x 8 x 4 in. thick	0.56	0.54	0.44				
--with cavity divider	0.48	0.46	0.38				
12 x 12 x 4 in. thick	0.52	0.50	0.41				
--with cavity divider	0.44	0.42	0.36				
12 x 12 x 2 in. thick	0.60	0.57	0.46				
Single Plastic Sheet	1.09	1.00	0.70				

¹See Part C for adjustment for various window and sliding patio door types.

²Double and triple refer to the number of lights of glass.

³Coating on either glass surface facing air space; all other glass surfaces uncoated.

⁴Dimensions are nominal.

*Reprinted with permission from ASHRAE Handbook of Fundamentals.

⁵For heat flow up.

⁶For heat flow down.

⁷Based on area of opening, not total surface area.

(See following page for Part C of this table.)

PART C
ADJUSTMENT FACTORS FOR VARIOUS WINDOW AND SLIDING PATIO DOOR TYPES
(Multiply U values in Parts A and B by these factors)

Description	Single Glass	Double or Triple Glass	Storm Windows
Windows			
All Glass ⁸	1.00	1.00	1.00
Wood Sash--80% Glass	0.90	0.95	0.90
Wood Sash--60% Glass	0.80	0.85	0.80
Metal Sash--80% Glass	1.00	1.20	1.20 ⁹
Sliding Patio Doors			
Wood Frame	0.95	1.00	--
Metal Frame	1.00	1.10	--

⁸Refers to windows with negligible opaque area.

⁹Value becomes 1.00 when storm sash is separated from prime window by a thermal break.

TABLE A-6
COEFFICIENTS OF TRANSMISSION (U) FOR SLAB DOORS*
Btu per (hr) (sq ft) (F Deg)

Thickness ¹	Winter			Summer, No Storm Door
	Solid Wood, No Storm Door	Storm Door ²		
		Wood	Metal	
1 in.	0.64	0.30	0.39	0.61
1-1/4 in.	0.55	0.28	0.34	0.53
1-1/2 in.	0.49	0.27	0.33	0.47
2 in.	0.43	0.24	0.29	0.42
	Steel Door			
1-3/4 in.				
A ³	0.59	--	--	0.58
B ⁴	0.40	--	--	0.39
C ⁵	0.47	--	--	0.46

¹Nominal thickness.

²Values for wood storm doors are for approximately 50% glass; for metal storm doors values apply for any percent of glass.

³A = Mineral fiber core (2 lb/cu ft).

⁴B = Solid urethane foam core.

⁵C = Solid polystyrene core.

Note: Hollow core doors 1-3/8 in. thick - R = 2.17; U = 0.46
1-3/4 in. thick - R = 2.22; U = 0.45

*Reprinted with permission from ASHRAE Handbook of Fundamentals.

APPENDIX B

FORMULA FOR DETERMINING THE OVERALL U_o OF THE WALL

$$U_o = \frac{U_{cav} A_{cav} + U_{sol} A_{sol} + U_{win} A_{win} + U_{door} A_{door} + U_{box} A_{box} + U_{found} A_{found}}{A_o}$$

Where:

- U_o = Average thermal transmittance of gross wall area.
- A_o = Gross area of exterior walls.
- U_{cav} = Thermal transmittance of cavity area (usually assume 80%)
- A_{cav} = Area between wall framing where insulation may be placed.
- U_{sol} = Thermal transmittance of wood framing area.
- A_{sol} = Area of wood framing (usually assume 20%)
- U_{box} = Thermal transmittance of box sill area.
- A_{box} = Area of box sill
- U_{found} = Thermal transmittance of foundation area.
- A_{found} = Area of above grade exposed concrete.
- U_{win} = Thermal transmittance of window.
- A_{win} = Total glass area.
- U_{door} = Thermal transmittance of door.
- A_{door} = Total door area.

FORMULA FOR DETERMINING THE OVERALL U_o OF THE CEILING

$$U_o = \frac{U_{cav} A_{cav} + U_{sol} A_{sol} + U_{skylight} A_{skylight}}{A_o}$$

Where:

- U_o = Average thermal transmittance of gross roof/ceiling.
- A_o = Gross area of roof/ceiling assembly.
- U_{cav} = Thermal transmittance of cavity area.
- A_{cav} = Area between wood framing.
- U_{sol} = Thermal transmittance of framing.
- A_{sol} = Area of wood framing (usually assume 10%)
- $U_{skylight}$ = Thermal transmittance of skylight elements.
- $A_{skylight}$ = Area of skylight (including frame).

APPENDIX C

INSULATION, EQUIPMENT AND CONDENSATION CONTROL

This appendix is a guide for the proper installation of insulation. The preceding appendices indicated the required amounts and types of insulation necessary to provide the various thermal resistance values for the building envelope. In order to attain the resistance values specified, it is important that the insulation be properly installed. This appendix includes types of materials currently available and common application practices.

Condensation control should be provided in the form of vapor barriers and thermal breaks. Vapor barriers should be installed on the warm side (area heated in winter) of all walls, ceilings, and insulated floors. All metal window, skylight, and door frames should contain a thermal break.

Insulation is manufactured in many forms and types. The most commonly used materials in residential construction are batts and blankets, rigid insulation, reflective insulation, loose fill, and sprayed insulation. The following is a list of types of materials and the federal specifications governing their characteristics.

Cork board	FS HH-I-561
Cellular glass	FS HH-I-551
Duct insulation	FS HH-I-558b
Expanded polystyrene insulation board	FS HH-I-524
Fiberboard	FS LLL-I-535 or ASTM C-208 Class C
Insulation board (urethane)	FS HH-I-530
Insulation, thermal (perlite)	FS HH-I-574
Mineral fiber, pneumatic or poured	FS HH-I-1030A
Mineral fiber, insulation blanket	FS HH-I-521E
Perlite	FS HH-I-526a
Perimeter insulation	FS HH-I-524a Type II FS HH-I-558b Form A, Class 1 or 2
Reflective, thermal	FS HH-I-1552
Structural fiberboard insulation roof deck	AIMA IB Spec. No. 1
Cellulose; vegetable or wood fiber	FS HH-I-515b-25
Vermiculite	FS HH-I-585
Vermiculite, water repellent loose fill	FHA UM-30
Mineral fiber, roof insulation	HH-I-526c

BATTS AND BLANKETS

These materials are usually identified on the package and on the vapor barrier facing with their "R" values. Under the federal specifications, there are 3 standard products identified as R-7, R-11, and R-19. These values are based on the insulation value of the mass. Some manufacturers offer other products such as R-8, R-13 and R-22. The specific thickness of insulation required for a specific "R" value may vary from one manufacturer to another due to differences in base materials and manufacturing processes.

General Guidelines

1. Install insulation so the vapor barrier faces the interior of the dwelling.
2. Vapor barriers should not be left exposed.
3. Insulate all voids of the building envelope including small spaces, gaps, around receptacles, pipes, etc.
4. Place insulation on the cold side of pipes and ducts (see Fig. 4). Insulation is not required for supply and return air ducts in heated basements and cellars.

Ceilings

There is a variety of methods for installing blanket insulation in ceilings.

1. Fastening from below (Fig. 1b).
2. Installing unfaced (without a vapor barrier), friction-fit blankets (Fig. 2).
3. Laying the insulation in from above when the ceiling finish material is in place (Fig. 1a).

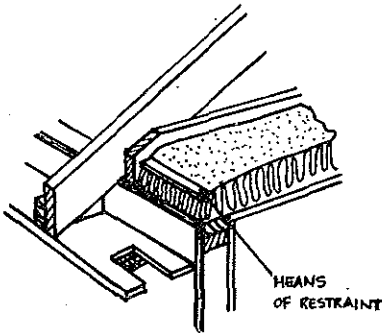

Fig. 1a

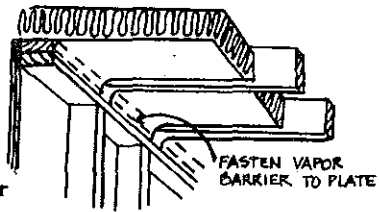

Fig. 1b

Fasten flanges to the inside of ceiling joists as shown in Fig. 1b. Extend the insulation entirely across the top plate, keeping the blanket as close to the plate as possible. Fasten vapor barrier to plate. When eave vents are used, the insulation should not block air movement from eave to space above insulation (Fig. 1a).

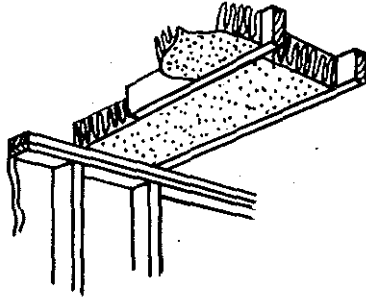

Fig. 2

Insert friction-fit blankets between ceiling joists (Fig. 2). Allow insulation to overlap the top plate of the exterior wall, but not enough to block eave ventilation. The insulation should be in contact with the top of the plate to avoid heat loss and air infiltration beneath the insulation. The required vapor barrier is not shown.

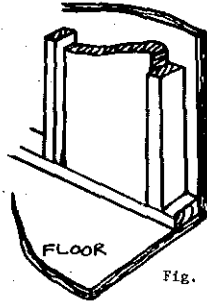

Fig. 3

Insert blankets into stud spaces. Working from the top down, space fasteners per manufacturers' recommendations, fitting flanges tightly against face of stud (Fig. 3). Cut blankets slightly over length and fasten the vapor barrier to the top and bottom plates.

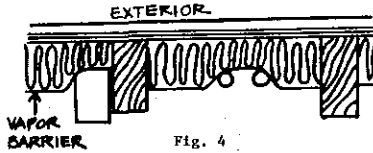

Fig. 4

Insert insulation behind (cold side in winter) pipes, ducts, and electrical boxes (Fig. 4).

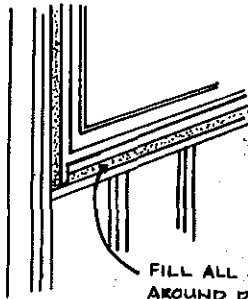

Fig. 5

FILL ALL CRACKS
AROUND DOORS AND WINDOWS
(COVER WITH VAPOR BARRIER)

Fill small spaces between rough framing and door and window heads, jambs and sills with pieces of insulation (Fig. 5).

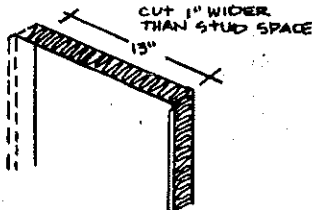

Fig. 6a

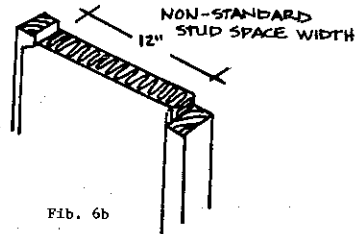

Fig. 6b

Insulate nonstandard-width stud or joist spaces by cutting the insulation and vapor barrier an inch or so wider than the space to be filled (Fig. 6a). Pull the vapor barrier on the cut side to the other stud, compressing the insulation behind it, and fasten through vapor barrier to stud face (Fig. 6b). Unfaced blankets are cut slightly oversize and fitted into place.

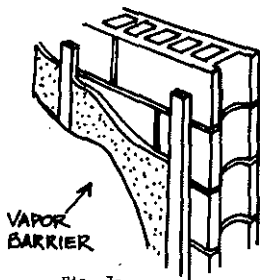

Fig. 7a

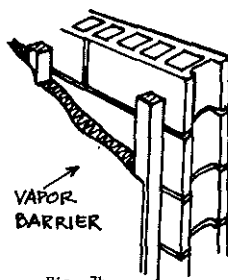

Fig. 7b

Masonry walls may be insulated by inserting insulation between furring strips spaced at 16 or 24 inches o.c. (Fig. 7a and 7b). It is recommended to apply the vapor barrier to the inside surface.

Floor and Crawl Spaces

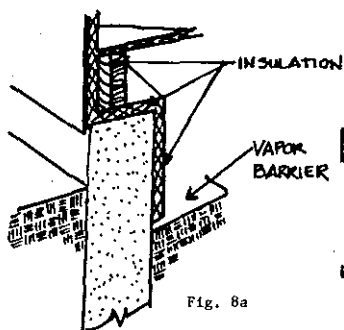

Fig. 8a

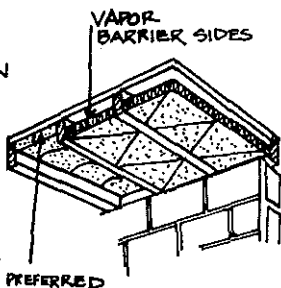

Fig. 8b

Floors over crawl spaces (Fig. 8a) should be insulated either by insulating the foundation walls or by placing insulation on or between the joists. Insulation should be securely fastened. In all cases, the vapor barrier side of the insulation should face the floor above; that is, be adjacent to the warm side in winter. A vapor barrier should be used to cover the ground.

Dropped Soffits

Insulation of dropped soffits over kitchen cabinets, bathtubs, showers, or similar areas, need special attention when they are exposed to the attic. If the dropped soffit is framed before ceiling finish material is applied, a "board" (plywood, hardboard, gypsumboard, etc.) should be installed over the cavity to support insulation.

In multiple dwellings with back-to-back kitchens or baths, it is necessary to extend ceiling finish material over dropped soffits to the party wall to avoid loss of acoustical control and to provide adequate fire stops.

Rigid Insulation

Rigid insulation is available in various sizes and thicknesses made of polystyrene, polyurethane, cork, cellular glass, mineral fiber (glass or rock wool), perlite, wood fiberboard, etc. They are used as insulation for masonry construction, as perimeter insulations around concrete slabs, as exterior sheathing under the weather barrier, as rigid insulations on top of roof decks, and other applications. Rigid insulations, such as polystyrene and polyurethane, are vapor barriers and, in most applications, will not require the installation of a separate barrier.

Installation Procedures

Masonry walls: Rigid insulations are applied to either face of a masonry wall (Fig. 9a and 9c) or are used as a cavity insulation between two wythes of masonry (Fig. 9b). When applied to the face of masonry walls, they are generally installed with adhesive and/or mechanical fasteners. The manufacturer's recommendation should be followed.

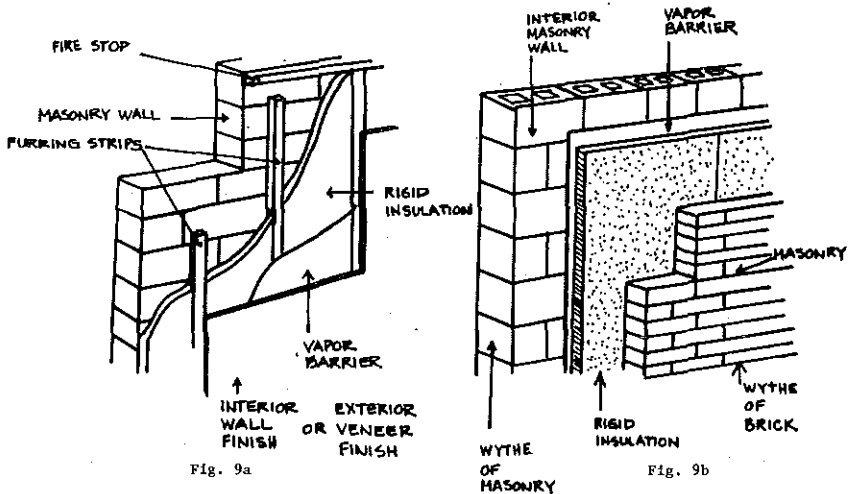

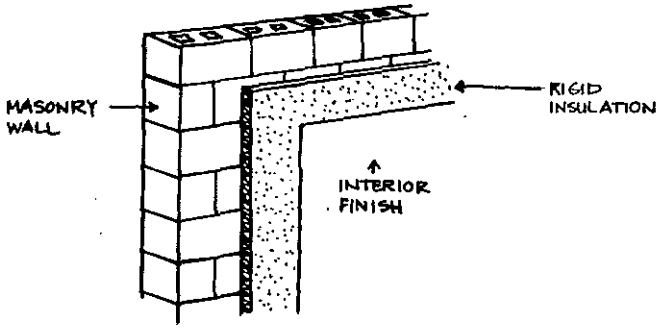

Fig. 9c

Frame Construction: When rigid insulation is used with frame construction (Fig. 10), it is usually applied as sheathing to the outside of the framing, and mechanically attached with nails to wood studs or to metal studs with screws or clips or other approved methods.

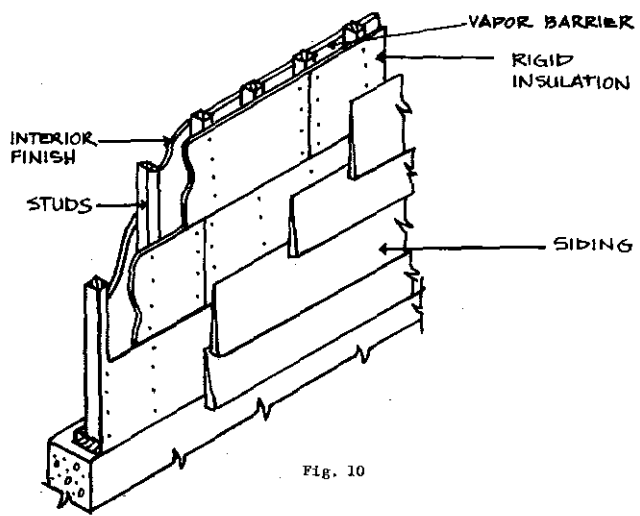

Fig. 10

Roof Insulation: Roof insulation boards are usually installed with an approved adhesive, hot asphalt, or may be nailed to the roof sheathing. The manufacturer's instructions should be followed.

Slab-on-Grade: Rigid insulation is frequently used as insulation around the perimeter of concrete slabs-on-grade (Fig. 11b, c, d) and also may be used on the inside of foundation walls adjacent to heated crawl spaces, basements or cellars (Fig. 11a). Installation is usually accomplished with adhesive and/or mechanical fasteners. Perimeter insulation should be installed against the foundation wall or extended into the interior of the building to a distance equal to the design frost line (Fig. 11b, c and d). Where the slab bears on the foundation ledge, the insulation should be a load-bearing type.

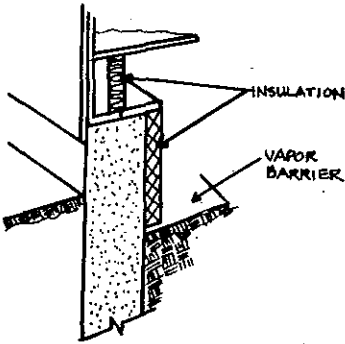

Fig. 11a

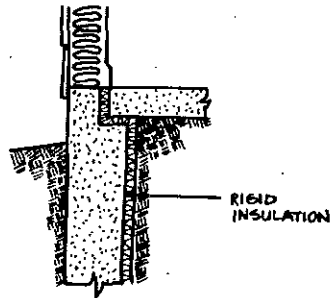

Fig. 11b

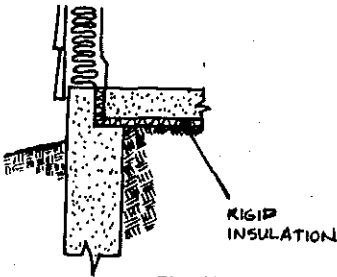

Fig. 11c

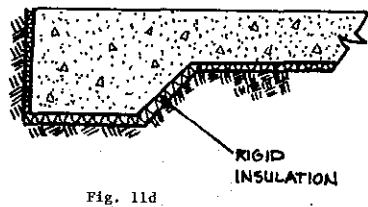
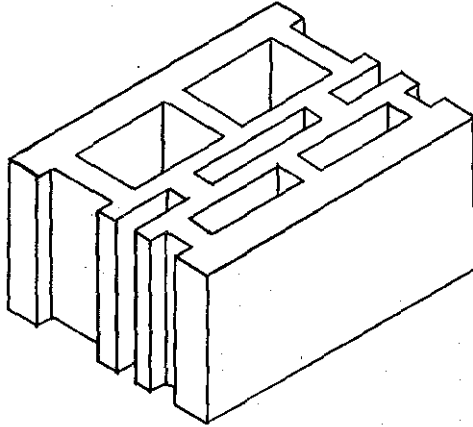

Fig. 11d

INSULATED CONCRETE BLOCK

Concrete block manufacturers are currently producing several types of multi-celled block with improved insulating values. The thermal resistance of the block will vary depending upon the types of insulation used and the configuration of the cells. An example of a typical multi-celled block is shown below.



LOOSE FILL INSULATION

Materials of this type are those made from mineral fibers (rock or glass), cellulose materials (wood fibers or shredded paper), or other manufactured products that can easily be poured.

BLOWN ATTIC INSULATION

There are several factors pertaining to blown attic insulation that can cause differences in its installed thermal resistance value (R). For a given manufacturer's insulation, the installed thermal resistance (R) value depends on thickness and weight of insulating material applied per square foot. Federal specification HH-I-1030A for insulation requires that each bag of insulation be labeled to show the minimum thickness, the maximum net coverage, and the minimum weight of (that particular) insulation material required per square foot to produce resistance values of R-30, 22, 19, and 11. A bag label example for blown insulation is shown in Fig. 12.

The number of bags of blown insulation required to provide a given R-value to insulate an attic of a given size may be calculated from data provided by the manufacturer. If only the thickness of blown attic insulation is specified, and the density or number of bags is not, the desired or assumed thermal resistance (R) value may not be achieved. The important characteristic is weight per square foot. Thickness is the minimum thickness, not the average thickness experienced in the field.

Adequate baffling of the vent opening or insulation blocking should be provided so as to deflect the incoming air above the surface of the installed blown or poured insulation. Baffles should be made of durable material securely fastened. Baffles should be in place at the time of framing inspection.

Three blown insulations that provide R-19 are:

<u>Material</u>	<u>Minimum Thickness</u>	<u>Maximum Net Coverage/Bag</u>	<u>Bags/1000 Sq. Ft.</u>
Cellulose	5-1/8"	59 sq. ft. (40 lb. bag)	17
Glass fiber	8-3/4"	51 sq. ft. (24 lb. bag)	20
Rock wool	6-1/2"	26 sq. ft. (27 lb. bag)	38

Bag Label Example: The manufacturer recommends these maximum coverages at these minimum thicknesses to provide the levels of installed insulation resistance (R) values shown:

(Based on 25-pound nominal weight bag)

<u>R-Value</u>	<u>Minimum Thickness</u>	<u>Minimum Weight per Sq. Ft.</u>	<u>Bags per 1000 Sq. Ft.</u>	<u>Maximum Net Coverage per Bag</u>
To obtain an insulation resistance R of:	Installed insulation should not be less than:	The weight per sq. ft. of installed insulation should be not less than:	Number of bags per 1000 sq. ft. of net area should not be less than:	Contents of this bag should not cover more than:
R-30	13-3/4 in. thick	0.768 lbs. per sq. ft.	30	33 sq. ft.
R-22	10 in. thick	0.558 lbs. per sq. ft.	22	45 sq. ft.
R-19	8-3/4 in. thick	0.489 lbs. per sq. ft.	20	51 sq. ft.
R-11	5 in. thick	0.279 lbs. per sq. ft.	11	90 sq. ft.

Weight contents: not less than 24 lbs.

R-values are determined in accordance with ASTM C-687 and C-236

Fig. 12

REFLECTIVE INSULATION

Reflective insulation is composed of aluminum foil in one or more layers either plain or laminated to one or both sides of kraft paper for structural strength. The insulation value for reflective air spaces, which this type of insulation provides, varies widely depending on the direction of heat flow. They are much more efficient when the heat flow is down. Reflective insulations which comply with the requirements when used in a floor, may not be satisfactory in ceilings or walls, where the heat flow is upward and horizontal, respectively. Reflective insulations are effective in controlling radiant heat energy when installed so that they face an air space. Insulation should be installed in such a manner that it is continuous, without holes or tears.

SPRAYED INSULATION

There are several types of insulation which are sprayed against the surface of the building materials or in cavities. Some of these are cellulose with binder, mineral wool with binder, and cellular foams. They may be sprayed directly on concrete, masonry, wood, plastic, or metal panels or may be sprayed between the framing members. Manufacturer's recommended instructions should be followed. To determine that the proper thickness is installed, either refer to the plans and specifications, or request a certification from the supplier that the insulation installed provides the required "R" value.

TYPICAL INSULATION THICKNESSES AND VALUES

<u>Insulation</u>	<u>Approximate R-Value</u>	<u>Thickness</u>
Fiber glass	11	3-1/2"
Fiber glass	13	3-5/8"
Fiber glass	19	6"
Fiber glass	30	8"
Fiber glass	38	12"
Extruded Polystyrene Foam	5.4	1"
Extruded Polystyrene Foam	10.8	2"

VAPOR BARRIERS

Vapor barriers are used in conjunction with insulation to decrease the chance of moisture condensation inside the building insulation. Vapor barriers are placed on the side of the wall, ceiling or floor that is warm in winter. For equal vapor pressures, moisture vapor penetration through holes or tears in the insulation vapor barrier is proportional to the size of the opening. Holes or tears should be repaired. A snug fit of blanket flanges against the framing is necessary to prevent moisture from bypassing the vapor barrier.

EQUIPMENT

The installation of the heating system can contribute to inefficiencies. A furnace which is oversized by a factor of 2 will require 8 to 10% more fuel than a furnace of correct size. An installation that has uninsulated ducts passing through an unheated crawl or attic space will lose about 1.5 Btu per hour per square foot of duct per degree of temperature differential between duct air and outside air. This can amount to 40% of a furnace output under mild conditions. Undersized ducting will reduce the amount of circulating air and will affect the capacity of the furnace, but will normally have little effect upon its efficiency. Atmospheric combustion equipment that draws its combustion and stack-dilution air from the heated space will require up to 8% more fuel in a season to heat the required makeup air than sealed combustion equipment. Stack heat recovery devices can recover from about 4% at 450° F to 8% at 800° F.

The appliance manufacturer should be consulted when retrofitting the appliance with combustion air to assure that the appliance warranty is not affected.

Effect of Sizing Limitation on Equipment

Using the example on system design illustrated in Appendix A, an analysis was made to see what impact or problem the proposal for limiting the size of equipment to 15% above the design losses would have.

Example:

Total construction loss	27,760 Btu/hour
One air change per hour:	
Inside volume = 12,188 cu. ft.	
$Q = (12,188)(90)(.018) = 19,744$ Btu/hour	
Total infiltration loss	<u>19,744 Btu/hour</u>
	<u>47,504 Btu/hour</u>

Maximum furnace size:

$$47,504 \text{ Btu/hour} + 47,504 (.15) \text{ Btu/hour} = 54,630 \text{ Btu/hour}$$

COMBUSTION AIR FOR FIREPLACES

It is recommended that combustion air from the exterior be provided for all fireplaces. Masonry fireplaces can be made more energy efficient with combustion air terminating in the fireplace. The opening of the fireplace should be equipped with a door and the combustion air duct with a damper and a louver to minimize air leakage during periods of nonuse.

CONDENSATION CONTROL

Air Infiltration

The department will accept infiltration losses determined by the air crack method or an overall value of 1/2 air change per hour.

The department will accept the use of engineered top-side moisture vent systems.

Relative Humidity

Winter: During the winter it is desirable to have humidity in the air in order to prevent the nostrils from becoming dry, furniture from cracking, etc. However, from an energy standpoint, it is desirable to keep the relative humidity low; the trade-off is at about 30%.

Summer: During the summer it is desirable to reduce the level of relative humidity in the building in relationship to the outside relative humidity. The relative humidity should be kept as high as possible in order to conserve energy, but low enough for comfort. The relative humidity should be kept above 55%, but less than 60%.

Amplified
P. 38

COMBUSTION AIR FOR FIREPLACES

It is recommended that combustion air from the exterior be provided for all fireplaces. Masonry fireplaces can be made more energy efficient with combustion air terminating in the fireplace. The opening of the fireplace should be equipped with a door and the combustion air duct with a damper and a louver to minimize air leakage during periods of nonuse.