

REPLACED, REGISTER,
JULY, 1978, NO. 271 *LND 22*
DEPT. OF INDUSTRY, LABOR & HUMAN RELATIONS 11

METHOD I - ACCEPTABLE PRACTICE METHOD

The acceptable practice method outlined below can be used with minimum calculations for determining the acceptable level of insulation.

Problem: Using the acceptable practice method determine the level of insulation required for the 1,500 square foot dwelling in Phase I.

Step 1: Determine the percentage window and door area.

$$\begin{aligned}\text{Percent opening area} &= \frac{\text{Window area} + \text{Door area}}{\text{Gross wall area} + \text{Box sill area}} \times 100\% \\ &= \frac{172.67 \text{ sq. ft.} + 37.82 \text{ sq. ft.}}{1512.18 \text{ sq. ft.} + 150.66 \text{ sq. ft.}} \times 100\% \\ &= \frac{210.49 \text{ sq. ft.}}{1,662.84 \text{ sq. ft.}} \times 100\% = 12.66\%\end{aligned}$$

Step 2: Determine level of insulation required for the box sill and sidewalls for the given window and door area from Table A-1, (Phase 1)

Using 5/8 inch plywood siding the table shows that an R-11 batt with R-1.22 fiberboard will allow up to 12.8% window and door area.

Step 3: Determine the percentage window area for the exposed foundation wall.

$$\begin{aligned}\text{Percent opening area} &= \frac{\text{Window area}}{\text{Total exposed foundation area}} \times 100\% \\ &= \frac{15.65 \text{ sq. ft.}}{108.97 \text{ sq. ft.} + 15.65 \text{ sq. ft.}} \times 100\% \\ &= 12.6\%\end{aligned}$$

Step 4: Determine the amount of exposed foundation wall:

If there is 8" of wall exposed and the wall height is 8',

$$\text{Percent exposed wall} = \frac{8'' / (12'' \text{ per foot})}{8'} \times 100\% = 8.3\%$$

Step 5: Consult with Table A-2 to determine the level of insulation required for the foundation.

Using the requirements for less than 25% exposed foundation wall the table shows that an R-5.27 insulation can be used for up to 10.4% single glazed windows.

Step 6: Select the level of insulation required for the ceiling from Table A-3.

TABLE A-1

WALL INSULATION GUIDE

(Based on U_o requirements above the foundation wall)

Insulation Type	Percent Window and Door Area					
	Phase I		Phase II (4/1/79)		Phase III (4/1/80)	
	$U_o = .14$		$U_o = .13$		$U_o = .12$	
	5/8 inch Plywood Siding	Backed Aluminum Siding	5/8 inch Plywood Siding	Backed Aluminum Siding	5/8 inch Plywood Siding	Backed Aluminum Siding
R-11 Batt	11.0	12.6	8.9	10.5	6.8	8.4
R-11 Batt, R-1.22 Fiberboard	12.8	14.0	10.8	12.0	8.7	9.9
R-11 Batt, R-5.27 Extruded Polystyrene	16.4	17.0	14.4	15.0	12.4	13.0
R-11 Batt, R-10.54 Extruded Polystyrene	18.8	19.1	16.8	17.2	14.9	15.3
R-13 Batt	12.5	13.9	10.4	11.8	8.3	9.8
R-13 Batt, R-1.22 Fiberboard	14.1	15.4	12.2	13.3	10.3	11.2
R-13 Batt, R-5.27 Extruded Polystyrene	17.0	17.5	15.0	15.6	13.1	13.6
R-13 Batt, R-10.54 Extruded Polystyrene	19.2	19.5	17.3	17.6	15.3	15.6
R-19 Batt	15.3	16.2	13.2	14.2	11.2	12.2
R-19 Batt, R-1.22 Fiberboard	16.4	17.1	14.4	15.1	12.3	13.1
R-19 Batt, R-5.27 Extruded Polystyrene	18.6	19.0	16.7	17.0	14.7	15.1
R-19 Batt, R-10.54 Extruded Polystyrene	20.1	20.4	18.2	18.5	16.3	16.6

Note: The following assumptions were used to derive this table:

1. Door area = 2% of wall and box sill area.
2. Insulated doors are used with a U-value of .47.
3. Insulated windows are used with a U-value of .56.
4. The insulation type is carried down through the box sill.

DEPT. OF INDUSTRY, LABOR & HUMAN RELATIONS 13

TABLE A-2
EXPOSED FOUNDATION INSULATION

Foundation exposure	Requirement	Insulation type	Percent window area	
			Single glazed	Double glazed
Less than 25% of foundation exposed	$U_o = .25$	R-5.27	10.4	24.8
		R-11 batt	15.5	34.2
		Multi-cell insul. block (R-12.06)	16.0	35.0
More than 25% of foundation exposed	$U_o = .14$	R-11 batt	4.9	10.8
		R-13 batt	5.8	12.7
		Multi-cell insul. block (R-12.06)	5.5	12.0
	$U_o = .13$	R-11 batt	3.9	8.7
		R-13 batt	4.8	10.6
		Multi-cell insul. block (R-12.06)	4.5	9.9
	$U_o = .12$	R-11 batt	3.0	6.7
		R-13 batt	3.9	8.5
		Multi-cell insul. block (R-12.06)	3.5	7.8

TABLE A-3
INSULATION LEVELS REQUIRED TO MEET CEILING U VALUES

U _o Value	Insulation	R-Value Required	
		In Cavity	Over Framing
.033	Fiber glass batt	R-19 and R-13	R-13
	Fiber glass blown	12 in. (R-30)	6.4 in. (R-16)
	Rock wool	9.7 in. (R-29)	4.2 in. (R-13)
	Cellulose	8.4 in. (R-31)	2.9 in. (R-11)
.029	Fiber glass batt	R-38	R-19
	Fiber glass blown	13.6 in. (R-34)	8.1 in. (R-20)
	Rock wool	10.9 in. (R-33)	5.4 in. (R-16)
	Cellulose	9.5 in. (R-35)	4.0 in. (R-15)

Note: The following assumptions were used to derive this table:

1. Fiber glass blown = R-2.5 per inch
2. Rock wool = R-3.0 per inch
3. Cellulose = R-3.7 per inch

METHOD II - SYSTEM DESIGN METHOD

The system design method is the more complex method of determining the level of insulation required by the code. This procedure may be used when it becomes necessary to combine various materials to comply with the code. If the window area is increased and the same wall insulation is used, the wall section will not meet the requirements of section Ind 22.06 (6), but the system design method can be used by adding extra insulation elsewhere.

Problem: Using the system design method, increase the opening area to 15% and determine compliance by adding extra insulation to the walls and ceiling.

Step 1: Determine the inside and outside design temperatures from Tables 22.04-A and B.

Inside temperature = 70 F

Outside temperature = -20 F

$$\Delta T = T_{\text{inside}} - T_{\text{outside}} = 70 - (-20) = 90 \text{ F}$$

Step 2: Using section Ind 22.06, determine the insulation values for the exterior walls above grade and the roof/ceiling for Phase I.

Exposed exterior walls above grade; $U_o = .15$

Roof/Ceiling; $U_o = .033$

Step 4: Fill in the worksheet to determine requirements for building enclosure heat loss.

Step 5: Select the levels of insulation to be used and determine the U values for the ceiling, wall, box sill and foundation. (Shown in Figure A-1)
Fill in the building enclosure worksheet.

Step 6: If the total heat loss determined through the system design method is within one percent or is less than the heat loss determined through the code requirements, the code has been satisfied.

R-VALUE DETERMINATION BY COMPONENT

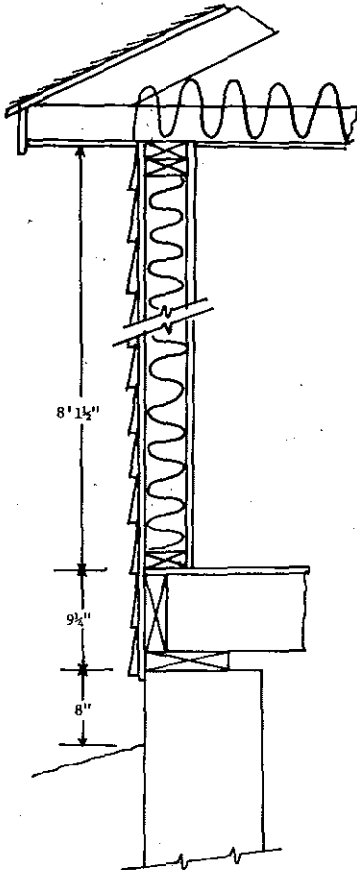

Figure A-1

Ceiling	Cavity R	Joist R
Top surface	.17	.17
Insulation	38.0	19.00
Wood	--	6.88
1/2" gyp. wall board	.45	.45
Bottom surface	.61	.61
	39.23	27.11
	(U=.025)	(U=.037)

Wall	Cavity R	Stud R
Outside surface	.17	.17
5/8" ext. siding	.77	.77
Rigid insulation	--	--
Insulation	11.00	--
Wood stud	--	6.88
1/2" gyp. wall board	.45	.45
Inside surface	.68	.68
	13.07	6.45
	(U=.070)	(U=.13)

Box sill	R
Outside surface	.17
5/8" ext. siding	.77
Rigid insulation	--
Insulation	11.00
1-1/2" wood	1.88
Inside surface	.68
	14.50
	(U=.064)

Foundation	R
Outside surface	.17
8" concrete	.64
Inside surface	.68
Rigid insulation	5.27
	6.76
	(U=.15)

REPLACED, REGISTER,
JULY, 1978, NO. 271
DEPT. OF INDUSTRY, LABOR & HUMAN RELATIONS 27

APPENDIX C

Effect of Sizing Limitation on Equipment

Using the example on system design illustrated in Appendix A, an analysis was made to see what impact or problem the proposal for limiting the size of equipment to 15% above the design losses would have.

Example:

Total construction loss 27,760 Btu/hour

One air change per hour:

Inside volume = 12,188 cu. ft.

$Q = (12,188)(90)(.018) = 19,744$ Btu/hour

Total infiltration loss $\frac{19,744 \text{ Btu/hour}}{47,504 \text{ Btu/hour}}$

Maximum furnace size:

$47,504 \text{ Btu/hour} + 47,504 (.15) \text{ Btu/hour} = 54,630 \text{ Btu/hour}$

Note: The department will accept infiltration losses determined by the air crack method. For electrically heated homes that are very tightly built and weatherstripped, one-half air change per hour may be used.

Relative Humidity

Winter: During the winter it is desirable to have humidity in the air in order to prevent the nostrils from becoming dry, furniture from cracking, etc. However, from an energy standpoint, it is desirable to keep the relative humidity low; the trade-off is at about 30%.

Summer: During the summer it is desirable to reduce the level of relative humidity in the building in relationship to the outside relative humidity. The relative humidity should be kept as high as possible in order to conserve energy, but low enough for comfort. The relative humidity should be kept above 55%, but less than 60%.

APPENDIX D

INSULATION INSTALLATION AND CONDENSATION CONTROL

This appendix is a guide for the proper installation of insulation. The preceding appendices indicated the required amounts and types of insulation necessary to provide the various thermal resistance values for the building envelope. In order to attain the resistance values specified, it is important that the insulation be properly installed. This appendix includes types of materials currently available and common application practices.

Condensation control should be provided in the form of vapor barriers and thermal breaks. Vapor barriers should be installed on the warm side (area heated in winter) of all walls, ceilings, and insulated floors. All metal window, skylight, and door frames should contain a thermal break.

Insulation is manufactured in many forms and types. The most commonly used materials in residential construction are batts and blankets, rigid insulation, reflective insulation, loose fill, and sprayed insulation. The following is a list of types of materials and the federal specifications governing their characteristics.

Cork board	FS HH-I-561
Cellular glass	FS HH-I-551
Duct insulation	FS HH-I-558b
Expanded polystyrene insulation board	FS HH-I-524
Fiberboard	FS LLL-I-535 or ASTM C-208 Class C
Insulation board (urethane)	FS HH-I-530
Insulation, thermal (perlite)	FS HH-I-574
Mineral fiber, pneumatic or poured	FS HH-I-1030A
Mineral fiber, insulation blanket	FS HH-I-521E
Perlite	FS HH-I-526a
Perimeter insulation	FS HH-I-524a Type II FS HH-I-558b Form A, Class 1 or 2
Reflective, thermal	FS HH-I-1552
Structural fiberboard insulation roof deck	AIMA IB Spec. No. 1
Cellulose; vegetable or wood fiber	FS HH-I-515b-25
Vermiculite	FS HH-I-585
Vermiculite, water repellent loose fill	FHA UM-30
Mineral fiber, roof insulation	HH-I-526c

BATTS AND BLANKETS

These materials are usually identified on the package and on the vapor barrier facing with their "R" values. Under the federal specifications, there are 3 standard products identified as R-7, R-11, and R-19. These values are based on the insulation value of the mass. Some manufacturers offer other products such as R-8, R-13 and R-22. The specific thickness of insulation required for a specific "R" value may vary from one manufacturer to another due to differences in base materials and manufacturing processes.

General Guidelines

1. Install insulation so the vapor barrier faces the interior of the dwelling.
2. Vapor barriers should not be left exposed.
3. Insulate all voids of the building envelope including small spaces, gaps, around receptacles, pipes, etc.
4. Place insulation on the cold side of pipes and ducts (see Fig. 4). Insulation is not required for supply and return air ducts in heated basements and cellars.

Ceilings

There is a variety of methods for installing blanket insulation in ceilings.

1. Fastening from below (Fig. 1b).
2. Installing unfaced (without a vapor barrier), friction-fit blankets (Fig. 2).
3. Laying the insulation in from above when the ceiling finish material is in place (Fig. 1a).

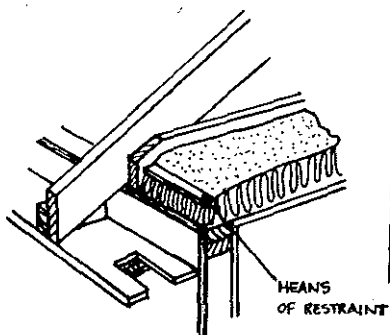

Fig. 1a

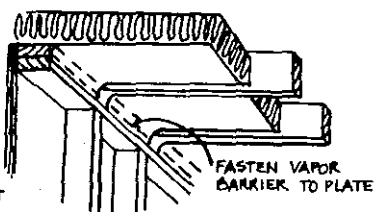

Fig. 1b

Fasten flanges to the inside of ceiling joists as shown in Fig. 1b. Extend the insulation entirely across the top plate, keeping the blanket as close to the plate as possible. Fasten vapor barrier to plate. When eave vents are used, the insulation should not block air movement from eave to space above insulation (Fig. 1a).

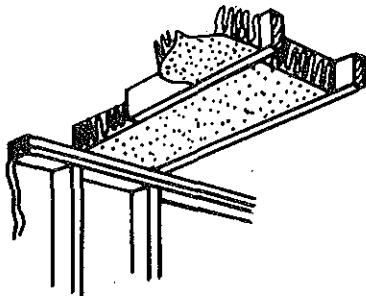

Fig. 2

Insert friction-fit blankets between ceiling joists (Fig. 2). Allow insulation to overlap the top plate of the exterior wall, but not enough to block eave ventilation. The insulation should be in contact with the top of the plate to avoid heat loss and air infiltration beneath the insulation. The required vapor barrier is not shown.

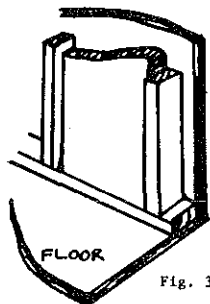

Fig. 3

Insert blankets into stud spaces. Working from the top down, space fasteners per manufacturers recommendations, fitting flanges tightly against face of stud (Fig. 3). Cut blankets slightly over length and fasten the vapor barrier to the top and bottom plates.

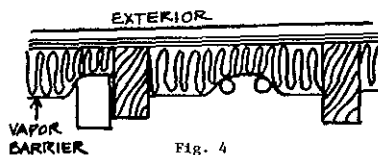

Fig. 4

Insert insulation behind (cold side in winter) pipes, ducts, and electrical boxes (Fig. 4).

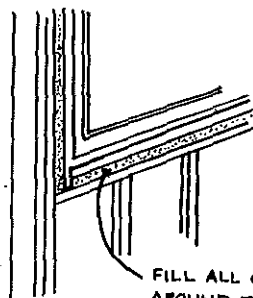

Fig. 5

FILL ALL CRACKS
AROUND DOORS AND WINDOWS
(COVER WITH VAPOR BARRIER)

Fill small spaces between rough framing and door and window heads, jambs and sills with pieces of insulation (Fig. 5).

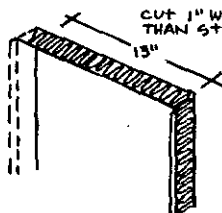

Fig. 6a

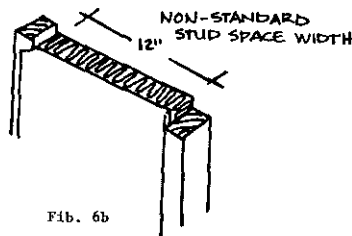

Fig. 6b

Insulate nonstandard-width stud or joist spaces by cutting the insulation and vapor barrier an inch or so wider than the space to be filled (Fig. 6a). Pull the vapor barrier on the cut side to the other stud, compressing the insulation behind it, and fasten through vapor barrier to stud face (Fig. 6b). Unfaced blankets are cut slightly oversize and fitted into place.

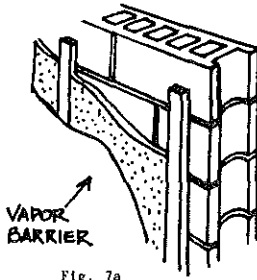

Fig. 7a

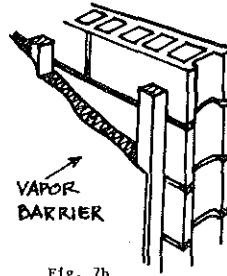

Fig. 7b

Masonry walls may be insulated by inserting insulation between furring strips spaced at 16 or 24 inches o.c. (Fig. 7a and 7b). It is recommended to apply the vapor barrier to the inside surface.

Floor and Crawl Spaces

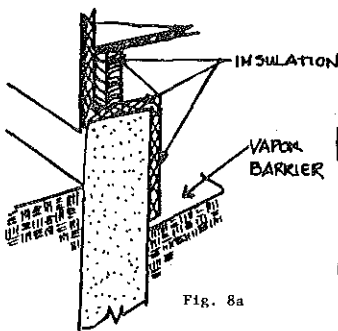

Fig. 8a

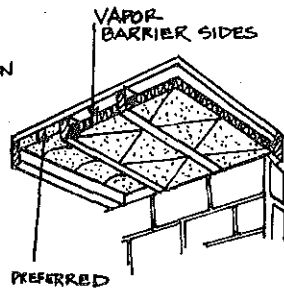

Fig. 8b

Floors over crawl spaces (Fig. 8a) should be insulated either by insulating the foundation walls or by placing insulation on or between the joists. Insulation should be securely fastened. In all cases, the vapor barrier side of the insulation should face the floor above; that is, be adjacent to the warm side in winter. A vapor barrier should be used to cover the ground.

Dropped Soffits

Insulation of dropped soffits over kitchen cabinets, bathtubs, showers, or similar areas, need special attention when they are exposed to the attic. If the dropped soffit is framed before ceiling finish material is applied, a "board" (plywood, hardboard, gypsumboard, etc.) should be installed over the cavity to support insulation.

In multiple dwellings with back-to-back kitchens or baths, it is necessary to extend ceiling finish material over dropped soffits to the party wall to avoid loss of acoustical control and to provide adequate fire stops.

Rigid Insulation

Rigid insulation is available in various sizes and thicknesses made of polystyrene, polyurethane, cork, cellular glass, mineral fiber (glass or rock wool), perlite, wood fiberboard, etc. They are used as insulation for masonry construction, as perimeter insulations around concrete slabs, as exterior sheathing under the weather barrier, as rigid insulations on top of roof decks, and other applications. Rigid insulations, such as polystyrene and polyurethane, are vapor barriers and, in most applications, will not require the installation of a separate barrier.

Installation Procedures

Masonry walls: Rigid insulations are applied to either face of a masonry wall (Fig. 9a and 9c) or are used as a cavity insulation between two wythes of masonry (Fig. 9b). When applied to the face of masonry walls, they are generally installed with adhesive and/or mechanical fasteners. The manufacturer's recommendation should be followed.

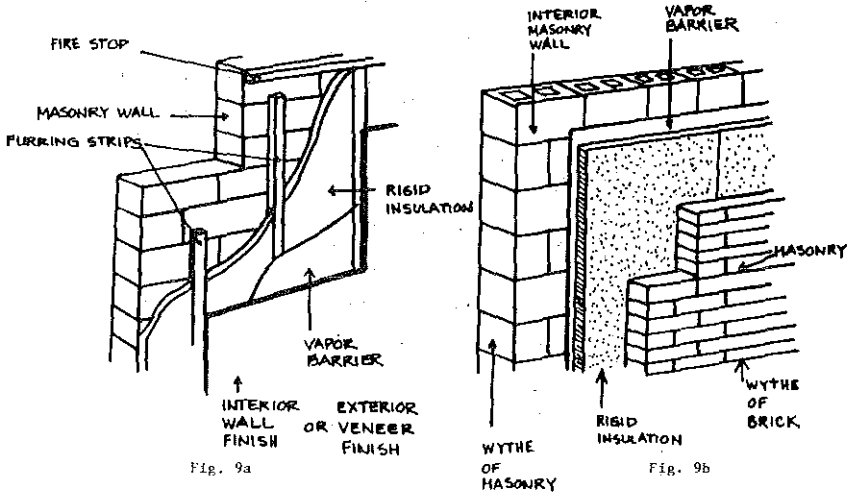

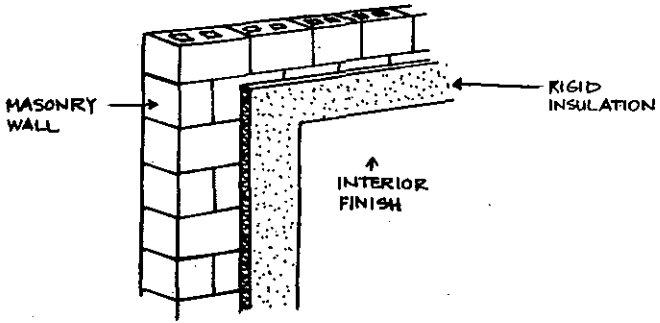

Fig. 9c

Frame Construction: When rigid insulation is used with frame construction (Fig. 10), it is usually applied as sheathing to the outside of the framing, and mechanically attached with nails to wood studs or to metal studs with screws or clips or other approved methods.

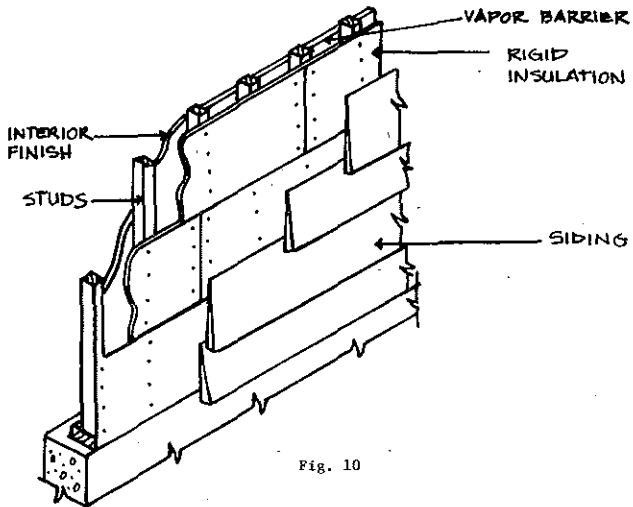

Fig. 10

Roof Insulation: Roof insulation boards are usually installed with an approved adhesive, hot asphalt, or may be nailed to the roof sheathing. The manufacturer's instructions should be followed.

Slab-on-Grade: Rigid insulation is frequently used as insulation around the perimeter of concrete slabs-on-grade (Fig. 11b, c, d) and also may be used on the inside of foundation walls adjacent to heated crawl spaces, basements or cellars (Fig. 11a). Installation is usually accomplished with adhesive and/or mechanical fasteners. Perimeter insulation should be installed against the foundation wall or extended into the interior of the building to a distance equal to the design frost line (Fig. 11b, c and d). Where the slab bears on the foundation ledge, the insulation should be a load-bearing type.

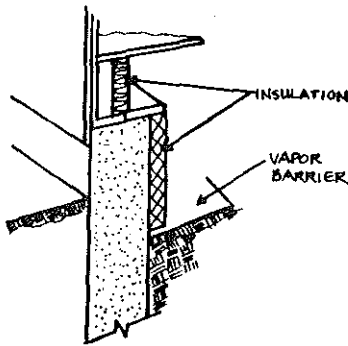

Fig. 11a

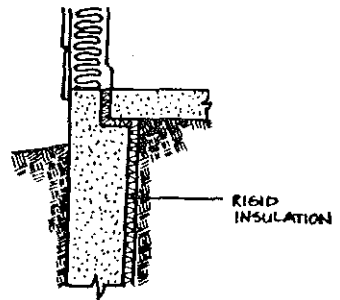

Fig. 11b

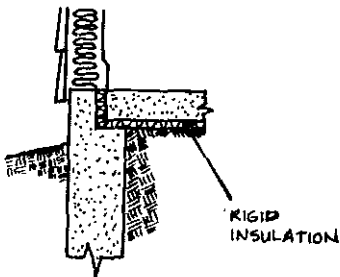

Fig. 11c

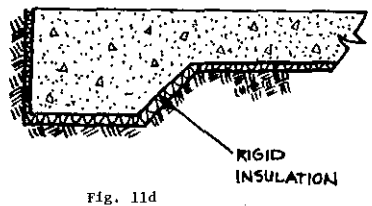
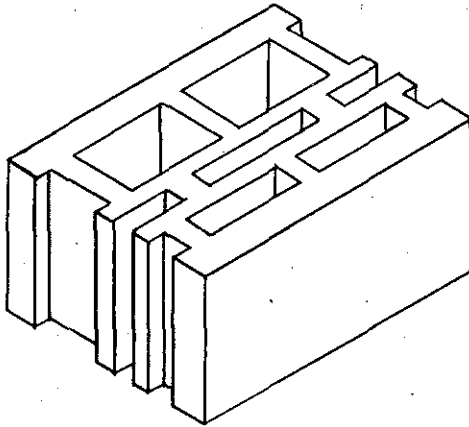

Fig. 11d

INSULATED CONCRETE BLOCK

Concrete block manufacturers are currently producing several types of multi-celled block with improved insulating values. The thermal resistance of the block will vary depending upon the types of insulation used and the configuration of the cells. An example of a typical multi-celled block is shown below.



LOOSE FILL INSULATION

Materials of this type are those made from mineral fibers (rock or glass), cellulose materials (wood fibers or shredded paper), or other manufactured products that can easily be poured.

BLOWN ATTIC INSULATION

There are several factors pertaining to blown attic insulation that can cause differences in its installed thermal resistance value (R). For a given manufacturer's insulation, the installed thermal resistance (R) value depends on thickness and weight of insulating material applied per square foot. Federal specification HH-I-1030A for insulation requires that each bag of insulation be labeled to show the minimum thickness, the maximum net coverage, and the minimum weight of (that particular) insulation material required per square foot to produce resistance values of R-30, 22, 19, and 11. A bag label example for blown insulation is shown in Fig. 12.

The number of bags of blown insulation required to provide a given R-value to insulate an attic of a given size may be calculated from data provided by the manufacturer. If only the thickness of blown attic insulation is specified, and the density or number of bags is not, the desired or assumed thermal resistance (R) value may not be achieved. The important characteristic is weight per square foot. Thickness is the minimum thickness, not the average thickness experienced in the field.

DEPT. OF INDUSTRY, LABOR & HUMAN RELATIONS 37

Adequate baffling of the vent opening or insulation blocking should be provided so as to deflect the incoming air above the surface of the installed blown or poured insulation. Baffles should be made of durable material securely fastened. Baffles should be in place at the time of framing inspection.

Three blown insulations that provide R-19 are:

Material	Minimum Thickness	Maximum Net Coverage/Bag	Bags/1000 Sq. Ft.
Cellulose	5-1/8"	59 sq. ft. (40 lb. bag)	17
Glass fiber	8-3/4"	51 sq. ft. (24 lb. bag)	20
Rock wool	6-1/2"	26 sq. ft. (27 lb. bag)	38

Bag Label Example: The manufacturer recommends these maximum coverages at these minimum thicknesses to provide the levels of installed insulation resistance (R) values shown:

(Based on 25-pound nominal weight bag)

R-Value	Minimum Thickness	Minimum Weight per Sq. Ft.	Bags per 1000 Sq. Ft.	Maximum Net Coverage per Bag
To obtain an insulation resistance R of:	Installed insulation should not be less than:	The weight per sq. ft. of installed insulation should be not less than:	Number of bags per 1000 sq. ft. of net area should not be less than:	Contents of this bag should not cover more than:
R-30	13-3/4 in. thick	0.768 lbs. per sq. ft.	30	33 sq. ft.
R-22	10 in. thick	0.558 lbs. per sq. ft.	22	45 sq. ft.
R-19	8-3/4 in. thick	0.489 lbs. per sq. ft.	20	51 sq. ft.
R-11	5 in. thick	0.279 lbs. per sq. ft.	11	90 sq. ft.

Weight contents: not less than 24 lbs,

R-values are determined in accordance with ASTM C-687 and C-236

Fig. 12

REFLECTIVE INSULATION

Reflective insulation is composed of aluminum foil in one or more layers either plain or laminated to one or both sides of kraft paper for structural strength. The insulation value for reflective air spaces, which this type of insulation provides, varies widely depending on the direction of heat flow. They are much more efficient when the heat flow is down. Reflective insulations which comply with the requirements when used in a floor, may not be satisfactory in ceilings or walls, where the heat flow is upward and horizontal, respectively. Reflective insulations are effective in controlling radiant heat energy when installed so that they face an air space. Insulation should be installed in such a manner that it is continuous, without holes or tears.

SPRAYED INSULATION

There are several types of insulation which are sprayed against the surface of the building materials or in cavities. Some of these are cellulose with binder, mineral wool with binder, and cellular foams. They may be sprayed directly on concrete, masonry, wood, plastic, or metal panels or may be sprayed between the framing members. Manufacturer's recommended instructions should be followed. To determine that the proper thickness is installed, either refer to the plans and specifications, or request a certification from the supplier that the insulation installed provides the required "R" value.

TYPICAL INSULATION THICKNESSES AND VALUES

<u>Insulation</u>	<u>Approximate R-Value</u>	<u>Thickness</u>
Fiber glass	11	3-1/2"
Fiber glass	13	3-5/8"
Fiber glass	19	6"
Fiber glass	30	8"
Fiber glass	38	12"
Extruded Polystyrene Foam	5.4	1"
Extruded Polystyrene Foam	10.8	2"

VAPOR BARRIERS

Vapor barriers are used in conjunction with insulation to decrease the chance of moisture condensation inside the building insulation. Vapor barriers are placed on the side of the wall, ceiling or floor that is warm in winter. For equal vapor pressures, moisture vapor penetration through holes or tears in the insulation vapor barrier is proportional to the size of the opening. Holes or tears should be repaired. A snug fit of blanket flanges against the framing is necessary to prevent moisture from bypassing the vapor barrier.

EQUIPMENT

The installation of the heating system can contribute to inefficiencies. A furnace which is oversized by a factor of 2 will require 8 to 10% more fuel than a furnace of correct size. An installation that has uninsulated ducts passing through an unheated crawl or attic space will lose about 1.5 Btu per hour per square foot of duct per degree of temperature differential between duct air and outside air. This can amount to 40% of a furnace output under mild conditions. Undersized ducting will reduce the amount of circulating air and will affect the capacity of the furnace, but will normally have little effect upon its efficiency. Atmospheric combustion equipment that draws its combustion and stack-dilution air from the heated space will require up to 8% more fuel in a season to heat the required makeup air than sealed combustion equipment. Stack heat recovery devices can recover from about 4% at 450° F to 8% at 800° F.

The appliance manufacturer should be consulted when retrofitting the appliance with combustion air to assure that the appliance warranty is not affected.