

## Chapter Ind 42

## REPAIRS, ADDITIONS, ALTERATIONS

Ind 42.01	Rules and reports	Ind 42.35	Application
Ind 42.02	Hydrostatic test	Ind 42.36	Inspection—general
Ind 42.03	Design of riveted patches	Ind 42.37	Qualifications of inspectors
Ind 42.04	Material for riveted patches	Ind 42.38	Inspection records
Ind 42.05	Workmanship on riveted patches	Ind 42.39	Determination of probable corrosion rate
Ind 42.06	Calculations for riveted patches	Ind 42.40	Maximum period between inspections
Ind 42.07	Examples of calculations for riveted patches	Ind 42.41	Inspection for corrosion
Ind 42.08	Welding procedure	Ind 42.42	Correction of corrosion rate
Ind 42.09	Welders	Ind 42.43	Inspection for defects
Ind 42.10	Rules for welding	Ind 42.44	Check of dimensions
Ind 42.11	Prohibited repairs	Ind 42.45	Pressure relief devices
Ind 42.12	Procedure	Ind 42.46	Temperature measuring devices
Ind 42.13	Defective weld	Ind 42.47	Allowable operation based on inspection data
Ind 42.14	Stress relieving operations	Ind 42.48	Allowable working pressure
Ind 42.15	Cracks, permissible welded repairs	Ind 42.49	Pressure test
Ind 42.16	Corroded surfaces and seal welding	Ind 42.50	Field repairs—general
Ind 42.17	Re-ending and piecing tubes	Ind 42.51	Defects in welded joints and plates
Ind 42.18	Patches, material	Ind 42.52	Corrosion pits
Ind 42.19	Flush or butt welded patches	Ind 42.53	Thickness gage holes
Ind 42.20	Lapped and fillet welded patches	Ind 42.54	Corroded or distorted flange faces
Ind 42.21	Stays	Ind 42.55	Cracks at tapped openings
Ind 42.22	Additional acceptable repair methods	Ind 42.56	Inadequate bolting material
Ind 42.25	Application	Ind 42.57	Field welding
Ind 42.26	Code constructed vessels	Ind 42.58	Applying patches to vessels by welding
Ind 42.27	Existing vessels	Ind 42.59	Riveting
Ind 42.28	Vessels from other states	Ind 42.60	Applying patches to vessels by riveting
Ind 42.29	Lap seam boilers	Ind 42.61	New connections
Ind 42.30	Prohibited boilers	Ind 42.62	Calking riveted vessels
Ind 42.31	Inspection and testing	Ind 42.63	Pressure test after repairs
Ind 42.32	Installation		
Ind 42.33	Portable boilers		

## PART VII

## REPAIRS, ADDITIONS, ALTERATIONS

Ind 42.01 Rules and reports. (1) Repairs, additions, or alterations to any boiler or pressure vessel or their fittings, settings, or appurtenances shall be made in accordance with sections Ind 42.01 through Ind 42.22 except that other methods may be used if submitted to and approved by the industrial commission. In the absence of specific rules, the rules for new construction shall apply.

(2) Manufacturers, owners, or contractors who make major repairs\* in accordance with these rules shall furnish the industrial commission with a report of every such major repair within 30 days after completion thereof. The report shall be signed by the authorized inspector who inspected the repair. The owner of the equipment on which major repairs were made shall retain a copy of the report in his files for review by an authorized inspector. The form to be used for the report shall contain the information shown in the following example:

\* See section Ind 41.02 (10)

**Record of Riveted or Welded Major Repairs**

This is to certify that the major repair made by or under the direction of the undersigned on \_\_\_\_\_  
(date of repair)

and consisting of \_\_\_\_\_  
(description of repair)

\_\_\_\_\_  
(On Boiler No.) (On Unfired Pressure Vessel No.)  
located in the plant of \_\_\_\_\_  
(Name of Pressure Vessel Owner)

\_\_\_\_\_  
(Address of Plant)

was made in accordance with the requirements of the Wisconsin industrial commission for repairs by riveting or fusion welding to power or miniature boilers and unfired pressure vessels. The welding was done by

\_\_\_\_\_  
who has made the test requirements of said rules.  
(Fill in only if a fusion welded repair)

Signed \_\_\_\_\_

Dated at \_\_\_\_\_ On \_\_\_\_\_

\_\_\_\_\_  
Employed by \_\_\_\_\_ Authorized Inspector  
**History:** Cr. Register, April, 1961, No. 64, eff. 5-1-61.

**Ind 42.02 Hydrostatic test.** Upon completion of repairs, a hydrostatic test of 150% of the maximum allowable working pressure shall be applied and the patch seams should be tight at this pressure.

**History:** Cr. Register, April, 1961, No. 64, eff. 5-1-61.

**Ind 42.03 Design of riveted patches.** It is the purpose of sections Ind 42.03 through Ind 42.07 covering the application of riveted patches, to restore to the weakened portion of the shell or head enough of its initial strength to permit the boiler to operate at its original working pressure. This involves calculations of the patch joints based on the shape and location of the patch. The rules herein given enable the efficiency of the patch joints to be readily determined. It is required that when riveted patches are considered necessary or desirable, they shall be applied under the following rules.

(1) The first thing that shall be taken into consideration when proceeding with the design of a patch is whether or not all of the end stress is to be carried by the patch; in other words, whether the heads are supported or unsupported. In drums of water tube boilers, the full end wise stress has to be carried by the shell plates and the patch seams, whereas in shells of horizontal tubular boilers some of the end wise stress is carried by the through rods, tube or flues, and consequently there is less stress on the shell and patch seams. It is evident

then that a patch in the one case need not have the same width for a given length as in the other case. In other words, different constants may be used in determining the width. Tables 9 and 10 take into account these 2 different conditions.

(2) The angle of a patch when laid out in the flat does not change when formed to the curvature of the boiler, therefore, the diameter of the boiler does not need to be taken into consideration in the design when the provisions of item (3) are met.

(3) (a) A patch shall be laid out in the flat and then carefully formed to accurately fit the contour of the boiler where it is to be applied.

(b) Patches shall be of the same thickness as the original thickness of the plate they replace.

(4) (a) Seams exposed to the products of combustion shall be single riveted lap construction.

(b) Seams not exposed to the products of combustion shall be double riveted or constructed similar to the original seams of the boiler.

(5) (a) Patches exceeding 24 inches in length shall have the proper width as determined by the rules herewith.

(b) Patches 24 inches or less in length shall be triangular, crescent, diamond or oval in form and the width shall be at least twice the length.

(6) (a) If it is found that a patch would extend extremely high it may be shortened in width to the extent that no more than 4 rivets will be in a longitudinal line, as shown in Figure 3.

(b) Likewise, to avoid the necessity of calking in sharp corners, a patch may be shortened in width to the extent that no more than 4 rivets will be in a longitudinal line, as shown in Figure 3.

(7) (a) If it is found that a patch would have to be 60 inches or more in length consideration shall be given to the use of a sheet having a width equivalent to  $\frac{5}{8}$  of the circumference of the boiler and the longitudinal seam shall be of a design similar to the design of the original seam of the boiler.

(b) In designing patches, it is not necessary to deal with angles in the term of degrees, but merely with the dimensions of the triangles forming a patch. The relation between the length and width provides certain fixed constants that have been tabulated and designated as Tables 9 and 10. The constant is the figure by which the length shall be multiplied to determine the width.

(c) If a patch is diamond in shape, it is considered equivalent to 2 triangular patches and half the total length is used in determining the width.

(d) As the angle of a patch as laid out when flat does not change when formed to the curvature of the boiler, the diameter of the boiler does not have to be taken into consideration in the design.

(8) (a) In laying out new patches over 24 inches long, it is recommended that they be triangular or diamond in shape, as may be required for the particular job, with definite straight line sides, but with the corners properly rounded out to permit proper calking, as illustrated in Figures 2, 3, 4, and 5.

(b) Where the length designated as "L" and the width designated as "W" is measured is also shown in Figures 2, 3, 4, and 5.

(9) (a) Rivets, patch bolts or staybolts may be used in "riveted" seams surfaces that are stayed or braced, provided at least one rivet or patch bolt is used between adjacent staybolts. The riveting shall be completed first.

(b) Rivet holes may be countersunk in patches on shells that have braced heads, if desired, without materially affecting the calculated strength of the patch. The angle of the chamfer with center line of the rivet hole shall not exceed 45° and the depth shall not exceed half the thickness of the plate.

(10) Where patches have already been applied the problem is to determine the effective diagonal efficiency. If the seams are all rounded, that is to say, the patch is crescent or oval in shape, the length "L" shall be taken between the center of the extreme two rivets on the longitudinal center line and the width "W" between the center of the extreme two rivets on the girthwise center line, as illustrated in Figures 6 and 7.

**History:** Cr. Register, April, 1961, No. 64, eff. 5-1-61.

**Ind 42.04 Material for riveted patches.** (1) Patch material shall be either fire box or flange steel. Structural steel shall not be used. The repair shop shall produce a copy of the manufacturer's mill test report of the material to be used.

(2) The material shall contain the steelmaker's brand. If only part of a plate is required and this part does not contain the brand, the brand shall be transferred to the patch plate in the presence of an authorized boiler inspector or a representative of the plate manufacturer, before the plate is cut. Rivets, patch bolts, or staybolts shall be of material of standard quality.

**History:** Cr. Register, April, 1961, No. 64, eff. 5-1-61.

**Ind 42.05 Workmanship on riveted patches.** (1) All patch plates shall be placed inside a boiler shell or drum where exposed to the products of combustion and where deposits would be pocketed. Where a patch plate includes the part to which the blow-off is attached, the patch shall be placed on the outside.

(2) All defective material exposed to the products of combustion shall be removed and properly trimmed to provide for neat workmanship in attaching the patch. Defects not exposed to the products of combustion need not be removed unless necessary to insure a workmanlike job.

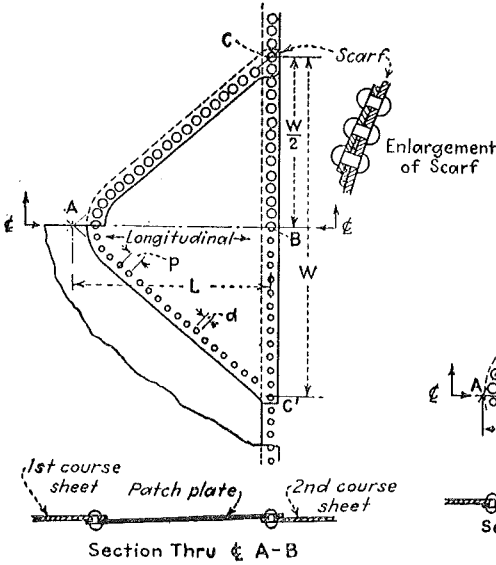
(3) A distorted sheet which is to be patched shall first be set back straight as much as possible before proceeding with the cutting out of the plate so that the patch may be kept as small as possible.

(4) The edge of a patch shall be beveled by planing, chipping, or gas cutting before applying it to the boiler. Rivets shall be driven by gun, if at all possible.

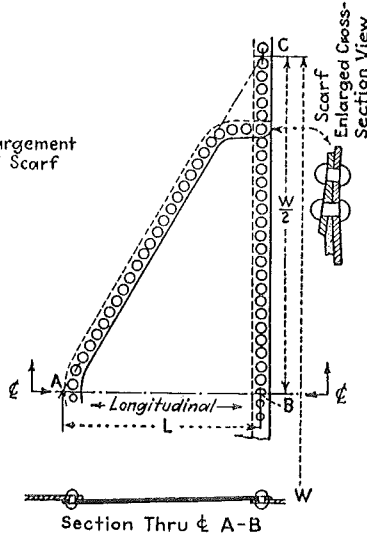
(5) All rivet holes shall be drilled full size or the holes may be punched not to exceed  $\frac{1}{4}$  inch less than full size for plates over  $\frac{1}{4}$

Register, November, 1971, No. 191  
Boiler and Unfired Pressure Vessel Code

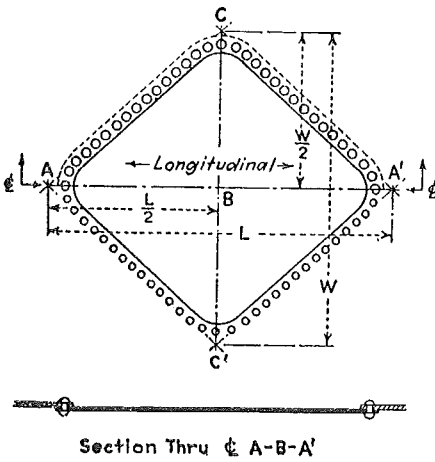
**Fig. 2**  
**TRIANGULAR PATCH**  
At girth seam on bottom of boiler (inside) as viewed from outside of boiler



**Fig. 3**  
Showing how patch may be shortened girthwise provided no more than 4 rivets are in a line parallel with the longitudinal seam.



**Fig. 4**  
**DIAMOND SHAPE PATCH**  
At centre of sheet (inside)



**Fig. 5**  
**TRIANGULAR PATCH**  
At head seam and blow-off on bottom of boiler (outside)

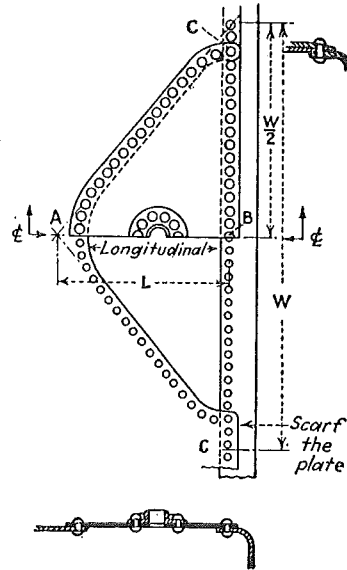


Fig. 6  
CRESCENT PATCH  
At Girth Seam

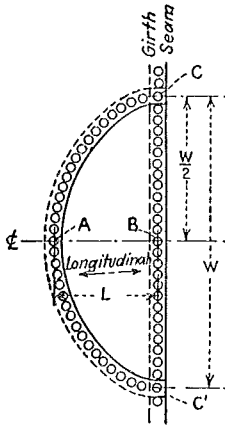
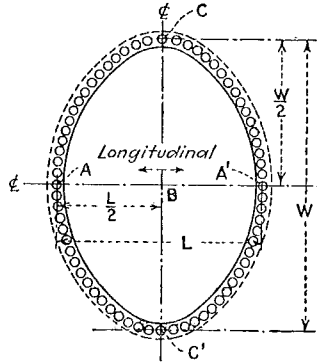


Fig. 7  
OVAL PATCH



inch, and  $\frac{1}{8}$  inch less for plates  $\frac{1}{8}$  inch or less in thickness, and then reamed to full size with patch in place. Rivet holes are usually  $\frac{1}{16}$  inch greater in diameter than the normal diameter of the rivet but a  $\frac{1}{32}$  inch difference is preferable when the rivets are of uniform size.

(6) If seal welding is used, it shall be laid in a single bead with a throat thickness not less than  $\frac{1}{8}$  inch, nor more than  $\frac{1}{4}$  inch. The patch shall be tight before seal welding under a hydrostatic test equal to the operating pressure.

(7) Where 3 plates have to be lapped at the corners of a patch, the middle plates shall be carefully scarfed to a feather edge the entire width of the lap, as shown in Figure 2.

**History:** Cr. Register, April, 1961, No. 64, eff. 5-1-61.

**Ind 42.06 Calculations for riveted patches.** (1) First the length  $L$  of the patch shall be determined. The dimension is, of course, governed by the area of the defect. Next, the normal efficiency,  $e$ , of the single-riveted seam that is to be used in the patch shall be determined from Table 8. This is governed by the thickness of plate and diameter of rivet holes.

(2) After determining the length that a patch shall be, the next step is to determine what the width girthwise shall be. This is found by multiplying the length by the constant,  $C$ , as shown in Table 9 or 10, depending upon the type of boiler to be repaired. These tables give a constant  $C$  for a given efficiency,  $e$ , of patch and efficiency,  $E$ , of longitudinal seam.

(3) To determine the longitudinal efficiency of an existing patch,  $L$  and  $W$  shall be measured, also the pitch,  $p$ , and diameter of rivet  $d$ .

Register, November, 1971, No. 191  
Boiler and Unfired Pressure Vessel Code

W divided by L will give the constant C. Table 8 will give e. Then under e in Table 9 or 10, depending upon the type of boiler to be repaired, find the constant C. Then whatever E at the left is found is the longitudinal or allowed efficiency of the patch seam (See section Ind 42.07).

TABLE 8  
EFFICIENCIES OF SINGLE-RIVETED SEAMS

Plate Thickness, t	Rivet Hole Diameter, d	Pitch of Rivets, p	Efficiency of Seam, e
1/8	1/8	1 1/4	63.3
3/16	3/16	1 1/8	60.0
1/4	3/8	1 1/8	60.0
5/16	1/2	1 1/8	58.0
3/8	5/8	1 1/8	57.0
7/16	3/4	1 1/2	57.5
1/2	7/8	2 1/8	56.0
5/8	1	2 1/8	56.5
3/4	1 1/8	2 1/4	55.7
7/8	1 1/4	2 3/8	53.0
1	1 1/2	2 1/2	52.8
1 1/8	1 3/4	2 3/4	50.5
1 1/4	2	2 3/4	51.4
1 1/2	2 1/8	2 3/4	51.4

Tensile strength assumed at 55,000 psi and shearing strength at 44,000 psi.

History: Cr. Register, April, 1961, No. 64, eff. 5-1-61.

Ind 42.07 Examples of calculations for riveted patches. (1) DESIGN OF PATCH FOR HORIZONTAL-TUBULAR BOILER. (a) A patch is to be placed in the fire sheet of a horizontal-return tubular boiler having shell plate 7/8 inch thick, a longitudinal seam efficiency of 74%, and a length of patch of 36 inches. Find the width W of patch to be applied so that there will not be any reduction in pressure, using a single-riveted seam of normal design.

(b) Referring to Table 8, it is found that a 7/8 inch plate with 1/2 inch diameter rivet holes, pitch 2 3/4 inch, gives a seam efficiency of 56%.

(c) Referring to Table 9, E-74 and e-56 give a constant C-1/75; then width  $W = L \times C = 36 \times 1.75 = 63$  inches.

(2) PRESSURE ALLOWANCE ON AN EXISTING PATCH FOR HORIZONTAL-TUBULAR BOILER. (a) A crescent shape patch has already been installed on a horizontal-tubular boiler. It is found to be 30 inches long and 48 inches wide. The seam is noted to be single-riveted with 1 1/8 inch riveted holes pitch 1 1/2 inch. The boiler shell plate is 5/8 inch thick. The longitudinal seam is of the double-riveted butt-strap type having an efficiency of 82%. The safety valve is set for 125 pounds pressure. What maximum pressure should be allowed on the boiler?

(b) Referring to Table 8, it shows that the normal efficiency of the patch seam is 57%.

TABLE 9  
TABLE OF CONSTANTS FOR USE IN COMPUTING PATCH SEAMS WHEN HEADS ARE SUPPORTED

	"e" efficiency of patch seams															
	.50	.51	.52	.53	.54	.55	.56	.57	.58	.59	.60	.61	.62	.63	.64	.65
.65	1.68	1.60	1.51	1.43	1.36	1.28	1.20	1.13	1.18	1.16	1.15	1.15	1.15	1.14	1.13	1.17
.66	1.73	1.67	1.53	1.50	1.42	1.35	1.27	1.19	1.24	1.23	1.22	1.21	1.20	1.19	1.18	1.23
.67	1.82	1.73	1.65	1.57	1.49	1.41	1.33	1.26	1.30	1.30	1.28	1.27	1.26	1.25	1.24	1.30
.68	1.88	1.79	1.70	1.63	1.55	1.47	1.40	1.32	1.36	1.35	1.34	1.33	1.32	1.31	1.30	1.35
.69	1.94	1.86	1.77	1.69	1.61	1.53	1.45	1.38	1.43	1.41	1.40	1.39	1.38	1.37	1.36	1.41
.70	2.01	1.91	1.83	1.75	1.67	1.59	1.52	1.44	1.48	1.47	1.45	1.44	1.43	1.42	1.41	1.46
.71	2.06	1.97	1.89	1.81	1.73	1.65	1.57	1.50	1.54	1.54	1.52	1.51	1.50	1.49	1.48	1.53
.72	2.12	2.03	1.95	1.86	1.79	1.71	1.63	1.56	1.60	1.60	1.58	1.57	1.56	1.55	1.54	1.59
.73	2.17	2.09	2.00	1.93	1.85	1.77	1.69	1.62	1.66	1.66	1.64	1.63	1.62	1.61	1.60	1.65
.74	2.22	2.14	2.06	1.98	1.91	1.83	1.75	1.67	1.71	1.71	1.69	1.68	1.67	1.66	1.65	1.70
.75	2.28	2.20	2.12	2.04	1.96	1.88	1.81	1.73	1.76	1.76	1.74	1.73	1.72	1.71	1.70	1.75
.76	2.34	2.25	2.17	2.09	2.02	1.93	1.86	1.78	1.82	1.82	1.80	1.79	1.78	1.77	1.76	1.81
.77	2.39	2.31	2.22	2.15	2.07	2.00	1.92	1.84	1.88	1.88	1.86	1.85	1.84	1.83	1.82	1.87
.78	2.44	2.36	2.28	2.20	2.13	2.05	1.97	1.89	1.93	1.93	1.91	1.90	1.89	1.88	1.87	1.92
.79	2.50	2.42	2.33	2.25	2.18	2.10	2.02	1.95	2.00	2.00	1.98	1.97	1.96	1.95	1.94	1.99
.80	2.55	2.46	2.38	2.30	2.23	2.15	2.08	2.00	2.05	2.05	2.03	2.02	2.01	2.00	1.99	2.04
.81	2.60	2.51	2.43	2.36	2.28	2.20	2.13	2.05	2.10	2.10	2.08	2.07	2.06	2.05	2.04	2.09
.82	2.65	2.56	2.48	2.40	2.33	2.25	2.18	2.11	2.15	2.15	2.13	2.12	2.11	2.10	2.09	2.14
.83	2.70	2.62	2.53	2.45	2.38	2.30	2.22	2.15	2.20	2.20	2.18	2.17	2.16	2.15	2.14	2.19
.84	2.75	2.66	2.58	2.51	2.43	2.35	2.27	2.20	2.25	2.25	2.23	2.22	2.21	2.20	2.19	2.24
.85	2.80	2.71	2.63	2.56	2.48	2.40	2.32	2.25	2.30	2.30	2.28	2.27	2.26	2.25	2.24	2.29
.86	2.85	2.77	2.68	2.60	2.52	2.45	2.37	2.30	2.35	2.35	2.33	2.32	2.31	2.30	2.29	2.34
.87	2.90	2.82	2.74	2.65	2.57	2.49	2.42	2.34	2.38	2.38	2.36	2.35	2.34	2.33	2.32	2.37
.88	2.96	2.87	2.78	2.71	2.62	2.54	2.47	2.39	2.44	2.44	2.42	2.41	2.40	2.39	2.38	2.43
.89	3.01	2.92	2.83	2.75	2.68	2.59	2.52	2.44	2.49	2.49	2.47	2.46	2.45	2.44	2.43	2.48
.90	3.01	2.97	2.89	2.80	2.71	2.65	2.57	2.50	2.55	2.55	2.53	2.52	2.51	2.50	2.49	2.54
.91	3.01	2.97	2.89	2.80	2.71	2.65	2.57	2.50	2.55	2.55	2.53	2.52	2.51	2.50	2.49	2.54
.92	3.01	2.97	2.89	2.80	2.71	2.65	2.57	2.50	2.55	2.55	2.53	2.52	2.51	2.50	2.49	2.54
.93	3.01	2.97	2.89	2.80	2.71	2.65	2.57	2.50	2.55	2.55	2.53	2.52	2.51	2.50	2.49	2.54
.94	3.01	2.97	2.89	2.80	2.71	2.65	2.57	2.50	2.55	2.55	2.53	2.52	2.51	2.50	2.49	2.54
.95	3.01	2.97	2.89	2.80	2.71	2.65	2.57	2.50	2.55	2.55	2.53	2.52	2.51	2.50	2.49	2.54

Constant "C" Triangle or crescent shape patches C = W ÷ L W = C × L L = W ÷ C  
 Diamond or oval shape patches C = 2W ÷ L W = C × L ÷ 2 L = 2W ÷ C



TABLE 10  
 TABLE OF CONSTANTS FOR USE IN COMPUTING PATCH SEAMS WHEN HEADS ARE UNSUPPORTED

Efficiency of longitudinal seams or diagonal efficiency—E	"e" efficiency of patch seams															
	.50	.51	.52	.53	.54	.55	.56	.57	.58	.59	.60	.61	.62	.63	.64	.65
65	2.20	2.06	1.93	1.80	1.69	1.56	1.45	1.35	1.24	1.14	1.12					
66	2.30	2.16	2.03	1.90	1.78	1.66	1.55	1.45	1.34	1.24	1.12					
67	2.40	2.26	2.13	2.00	1.88	1.76	1.65	1.55	1.44	1.32	1.12					
68	2.50	2.36	2.23	2.10	1.98	1.86	1.73	1.63	1.52	1.42	1.31					
69	2.60	2.46	2.33	2.20	2.07	1.95	1.84	1.71	1.61	1.50	1.40	1.19				
70	2.72	2.57	2.43	2.30	2.16	2.04	1.93	1.80	1.69	1.59	1.49	1.37	1.17			
71	2.80	2.65	2.51	2.40	2.26	2.14	2.02	1.90	1.79	1.77	1.57	1.47	1.35	1.16		
72	3.00	2.81	2.68	2.60	2.46	2.33	2.20	2.09	1.97	1.87	1.66	1.56	1.45	1.36	1.15	
73	3.12	2.92	2.79	2.71	2.56	2.42	2.30	2.19	2.06	1.93	1.73	1.64	1.54	1.44	1.35	1.14
74	3.28	3.07	2.94	2.83	2.68	2.52	2.40	2.27	2.24	2.12	1.83	1.73	1.64	1.52	1.43	1.24
75	3.38	3.17	3.00	2.96	2.78	2.62	2.49	2.36	2.24	2.12	1.83	1.73	1.64	1.52	1.43	1.24
76	3.52	3.32	3.14	3.07	2.90	2.74	2.58	2.45	2.32	2.22	2.10	1.81	1.71	1.61	1.51	1.42
77			3.40	3.32	3.16	2.97	2.80	2.65	2.42	2.30	2.19	1.98	1.88	1.77	1.67	1.58
78				3.46	3.20	3.03	2.85	2.70	2.42	2.30	2.27	2.07	1.88	1.77	1.67	1.58
79					3.40	3.16	2.92	2.75	2.51	2.39	2.27	2.16	1.99	1.86	1.75	1.66
80						3.46	3.10	2.92	2.61	2.48	2.36	2.24	2.09	1.94	1.84	1.74
81							3.20	2.97	2.71	2.57	2.45	2.33	2.14	1.92	1.82	1.73
82								3.34	2.87	2.67	2.53	2.42	2.21	2.00	1.92	1.83
83									3.20	2.82	2.63	2.48	2.27	2.11	2.00	1.90
84										2.98	2.78	2.63	2.39	2.19	2.09	1.98
85											3.05	2.87	2.63	2.37	2.17	2.06
86												3.17	2.89	2.67	2.42	2.25
87													3.22	2.97	2.75	2.54
88														3.25	2.84	2.63
89															3.24	2.50
90																2.40
91																2.47
92																2.65
93																2.75
94																2.83
95																2.93
																3.03
																3.11
																3.28
																3.43

Constant "C" Triangle or crescent shape patches  $C = W \div L$   $W = C \times L$   $L = W \div C$   
 Diamond or oval shape patches  $C = 2W \div L$   $W = C \times L \div 2$   $L = 2W \div C$

(c) If the efficiency is not found in the table, refer to any other available table or determine it in the customary manner described in sections Ind 41.50 and Ind 41.51 of this code.

(d) Divide the width of the patch  $W = 48$  inches by the length  $L = 30$  inches to find the constant  $C = 48/30 = 1.60$ .

(e) Follow down column  $e = 0.57$  of Table 9 until 1.60 is found. It will be noted that this is somewhere between 1.56 and 1.62 representing  $E$  somewhere between 0.72 and 0.73. As the difference between 1.56 and 1.62 is 6, and the difference between 1.56 and 1.60 is 4,  $E$  will be 0.72 plus  $4/6$  of 0.001 which is 0.7266.

(f) The pressure approved varies directly as the seam efficiency. Accordingly  $P = 0.7266/0.82 \times 125 = 110$  pounds per square inch.

(g) If this allowance interferes with the operation of the plant, the patch will have to be replaced by a new one with proper dimensions giving a diagonal efficiency of 82%.

(3) DESIGN OF PATCH FOR WATER-TUBE BOILER. (a) Sections of the plate having a total length of 36 inches (measured at the pitch line) are to be removed on each side of a girth seam. The patch is to be diamond or oval shape. The shell plate is  $\frac{7}{8}$  inches thick and the longitudinal seam is double-riveted butt strap construction, having an efficiency of 82%. What should be the width of the patch for maintaining the same pressure allowance?

(b) Referring to Table 8, it shows that a single-riveted lap seam with  $\frac{7}{8}$  inch plate,  $\frac{11}{16}$  inch diameter rivet holes, and  $2\frac{1}{2}$  inch pitch has a normal efficiency of 56%.

(c) Referring to Table 10, it shows for  $E = 0.82$  and  $e = 0.56$ , the constant  $C$  is 3.16.

(d) Then width  $W = C \times L \div 2$

$$W = 3.16 \times 36 \div 2 = 56.88, \text{ say } 57 \text{ inches.}$$

**History:** Cr. Register, April, 1961, No. 64, eff. 5-1-61.

**Ind 42.08 Welding procedure.** Manufacturers, owners or contractors undertaking repairs under these rules shall have available for the inspector a written welding procedure specification that shall be followed in making the necessary repair and also a record of procedure qualification tests. Welding procedure specifications shall have been prepared and qualified in accordance with the requirements of sections Ind 41.50 and Ind 41.51 of this code under Welding Qualifications, section Ind 41.50 (6). Repairs by fusion welding on low pressure steam and hot water boilers shall be exempt from the provisions of sections Ind 42.01 through Ind 42.21, except that a qualified welder shall be required for such repairs and the repairs shall conform to sections Ind 42.10, Ind 42.11, Ind 42.12, Ind 42.13 and Ind 42.20.

**History:** Cr. Register, April, 1961, No. 64, eff. 5-1-61.

**Ind 42.09 Welders.** (1) **WELDER QUALIFICATION.** Manufacturers, owners or contractors shall have available for the inspector records of welder qualification tests showing that each welder to be employed on the work has satisfactorily passed tests as prescribed in sections Ind 41.50 and Ind 41.51 of this code under Welding Qualifications for the type of filler metal to be used and for each position in which he will be called upon to operate in making the repair.

(2) **WELDING TESTS, MANUFACTURER'S, OWNER'S OR CONTRACTOR'S RESPONSIBILITY, INSPECTOR'S DUTY.** Preparation of welding procedure

Register, November, 1971, No. 191  
Boiler and Unfired Pressure Vessel Code

specifications and the conducting of tests of procedures and welders shall be the responsibility of the manufacturer, owner or contractor. Before repairs are started, it shall be the duty of the inspector to satisfy himself by examination of the written welding procedure and records of qualification tests that procedures and welders have been properly qualified as required in section Ind 41.50 (6). Witnessing of the tests by the inspector shall not be mandatory but he shall have the right to witness such tests when he deems it necessary. The inspector shall also have the right to call for and witness the making of test plates by any welder, at any time, and to observe the physical testing of such plates.

**History:** Cr. Register, April, 1961, No. 64, eff. 5-1-61.

**Ind 42.10 Rules for welding.** The repairs that may be made under these rules are limited to steels of flange or fire box quality having known weldable quality and further limited to carbon steels having a carbon content of not more than 0.35%. Structural steel shall not be used. The welding of high alloy material and non-ferrous material shall be done in accordance with the requirements of sections Ind 41.50 and Ind 41.51 of this code for boilers and unfired pressure vessels.

**History:** Cr. Register, April, 1961, No. 64, eff. 5-1-61.

**Ind 42.11 Prohibited repairs.** A welder shall not make repairs in a plate thickness in excess of that permitted under sections Ind 41.50 and Ind 41.51 of this code for welding qualifications. A welder shall not make repairs on a material that is not covered within his qualification tests.

**History:** Cr. Register, April, 1961, No. 64, eff. 5-1-61.

**Ind 42.12 Procedure.** Groove welds shall completely penetrate the thickness of the material being welded. If possible, welding shall be applied from both sides of the plate or a backing strip or ring may be used to insure complete penetration. Manually applied welds shall have a convex surface on both sides if applied on both sides of the plates being joined, or on one side if welding is applied from one side only. Valleys and undercutting at edges of welded joints shall not be permitted. The reinforcement may be chipped, ground, or machined off flush with the base metal, if so desired, after the welding has been completed.

**History:** Cr. Register, April, 1961, No. 64, eff. 5-1-61.

**Ind 42.13 Defective weld.** In making a repair to a weld that has failed in service, the defective weld shall be removed by chipping, grinding or gouging until sound metal is reached on all sides. The resulting groove shall be filled as required by the applicable welding procedure.

**History:** Cr. Register, April, 1961, No. 64, eff. 5-1-61.

**Ind 42.14 Stress relieving operations.** (1) In repairing carbon or low alloy steels, when required by these rules and considered necessary by the authorized inspector, thermal stress relieving shall be applied to the completed work. The heat may be applied by any means that will raise the temperature of the material being heated gradually and uniformly to approximately 1,200 F. (In the absence of more accurate means of determining temperature, a dull red glow in daylight will suffice.) This temperature shall be maintained for a period of one hour

Register, November, 1971, No 191  
Boiler and Unfired Pressure Vessel Code

per inch of thickness of material. For circumferential joints, the area heated shall comprise a band extending completely around the cylinder and having a width on each side of the center line of the weld not less than 3 times the greatest width of the finished weld. For nozzles, the heated area shall comprise a circumferential band extending around the entire vessel, including the nozzle or welded attachment and shall extend at least 6 times the plate thickness beyond the welding which connects the nozzle or other attachment to the vessel. Under certain conditions other methods of thermal stress relieving acceptable to the authorized inspector may be used. Under certain conditions preheating may be necessary.

(2) Upon completion of the stress relieving operation, the plate shall be allowed to cool at a rate not greater than 500 F. per hour divided by the maximum thickness of the welded part in inches, but in no case more than 500 F. per hour. This rate of cooling shall be maintained until a temperature of approximately 600 F. is reached, after which normal cooling by exposure in a still atmosphere may be permitted.

(3) Thermal stress relieving of austenitic steels is a controversial subject. It shall not be attempted except in accordance with the recommendations of the manufacturer of the material or the requirements of sections Ind 41.50 and Ind 41.51 of this code.

(4) In lieu of thermal stress relieving of carbon steels, peening or other methods acceptable to the authorized inspector may be employed.

**History:** Cr. Register, April, 1961, No. 64, eff. 5-1-61.

**Ind 42.15 Cracks, permissible welded repairs. CAUTION.** Before making welded repairs, care should be taken to investigate the cause of the cracks. Where circumstances indicate that welding cracks is likely to result in recurrence, consideration should be given to cutting out the cracked area and installing a patch.

(1) Cracks in unstayed shells, drums or headers of boilers or pressure vessels may be repaired by welding, providing the cracks do not extend between rivet holes in a longitudinal seam or parallel to a rivet seam within 8 inches, measured from nearest calking edge. The total length of any one such crack shall not exceed 8 inches. Cracks of a greater length may be welded, provided the complete repair is radiographed and stress relieved in accordance with section Ind 42.14. See Figures 8 and 8(a) for acceptable methods.

(2) Cracks of any length in unstayed furnaces may be welded, provided the welds are thermally stress relieved in accordance with section Ind 42.14. Welds applied from both sides of the plate shall be used where possible. Welds applied from one side only shall be subject to the approval of the authorized inspector. Field repair of cracks at knuckle or turn of flange of furnace opening are prohibited unless specifically approved by the industrial commission. See Figure 9 for acceptable methods.

(3) Cracks of any length in stayed areas may be repaired by fusion welding except that multiple or star cracks radiating from rivet or staybolt holes shall not be welded. See Figure 10 for acceptable methods.

**History:** Cr. Register, April, 1961, No. 64, eff. 5-1-61.

Register, November, 1971, No. 191  
Boiler and Unfired Pressure Vessel Code

**Ind 42.16 Corroded surfaces and seal welding.** (1) Corroded areas in stayed surfaces may be built up by fusion welding, provided the remaining plate has an average thickness of not less than 50% of the original thickness, and further provided that the areas so affected are not sufficiently extensive to impair the safety of the object. See Figure 11 for acceptable methods.

(2) Corroded areas around manhole or handhole openings in either stayed or unstayed plates may be built up by fusion welding, provided the average loss of thickness does not exceed 50% of the original plate thickness and also provided the area to be so repaired does not extend more than 3 inches from the edge of the hole.

(3) Corroded areas in unstayed shells, drums or headers may be built up by fusion welding provided that in the judgment of the authorized inspector, the strength of the structure has not been impaired. See Figure 12 for acceptable methods.

(4) Edges of butt straps or of plate laps and nozzles or connections attached by riveting may be restored to original dimensions by welding. Seal welding shall not be used except with the special approval of the authorized inspector, and in no case where cracks are present in riveted areas. See Figure 13 for acceptable methods.

(5) The ends of tubes in fire tube and water tube boilers may be seal welded provided they have not been reduced more than 10% in thickness, and requirements of sections Ind 41.50 and Ind 41.51 of this code are satisfied. See Figure 14 for acceptable methods.

**History:** Cr. Register, April, 1961, No. 64, eff. 5-1-61.

**Ind 42.17 Re-ending and piecing tubes.** Re-ending or piecing of tubes or pipes in either fire tube or water tube boilers is permitted provided the thickness of the tube or pipe has not been reduced by more than 10% from that required by sections Ind 41.50 and Ind 41.51 of this code for the pressure to be carried. In all cases the requirements of sections Ind 41.50 and Ind 41.51 of this code shall be met.

**History:** Cr. Register, April, 1961, No. 64, eff. 5-1-61.

**Ind 42.18 Patches, material.** The material used for patches shall be of the same general quality and have at least the minimum physical properties of the plate to be patched. The thickness of any patch shall be at least equal to, but not more than,  $\frac{1}{8}$  inch greater than the plate being patched.

**History:** Cr. Register, April, 1961, No. 64, eff. 5-1-61.

**Ind 42.19 Flush or butt welded patches.** (1) Flush or butt welded patches in unstayed shells, drums or headers shall be radiographed and stress relieved to conform to the requirements of sections Ind 41.50 and Ind 41.51 of this code for new construction. Subject to the approval of an authorized inspector, peening or other methods of stress relieving may be substituted for thermal stress relieving. Subject to compliance with this requirement, no limit is placed on dimensions or location of such patches or on the thickness of the material. When the longest dimension of a patch does not exceed 16 times the plate thickness or a maximum of 8 inches, radiographing and stress relieving is not required. See Figure 15 for acceptable methods.

(2) Flush or butt welded patches or new sections may be applied to stayed plates without limitation of size or plate thickness. See Figure 16 for acceptable methods.

**History:** Cr. Register, April, 1961, No. 64, eff. 5-1-61.

**Ind 42.20 Lapped and fillet welded patches.** Lapped and fillet welded patches may be applied to stayed plates provided they are not exposed to radiant heat. Lapped and fillet welded patches may be applied on the pressure side of the sheet in unstayed areas, provided the maximum diameter of the opening so repaired does not exceed 16 times the thickness of the plate, but in no case larger than 8 inches in diameter. See Figure 17 for acceptable methods.

**History:** Cr. Register, April, 1961, No. 64, eff. 5-1-61.

**Ind 42.21 Stays.** (1) Threaded stays may be replaced by welded-in stays provided that in the judgment of the inspector the plate adjacent to the stay bolt has not been materially weakened by deterioration or wasting away. All requirements of the applicable section of sections Ind 41.50 and Ind 41.51 of this code governing welded-in stays shall be met, except that stress relieving other than thermal may be used as provided in section Ind 42.14.

**History:** Cr. Register, April, 1961, No. 64, eff. 5-1-61.

**Ind 42.22 Additional acceptable repair methods.** Repairs and repair methods not discussed in the chapter shall comply with methods illustrated in Figures 18, 19, 20 and 21.

**History:** Cr. Register, April, 1961, No. 64, eff. 5-1-61.

## PART VIII

### SECOND HAND BOILERS—SECOND HAND UNFIRED PRESSURE VESSELS—PORTABLE BOILERS

**Ind 42.25 Application.** Sections Ind 42.25 through Ind 42.33 shall apply to second hand boilers, second hand unfired pressure vessels installed after July 1, 1960 on which both the ownership and location were changed, and shall also apply to portable boilers (See Ind 42.33).

**History:** Cr. Register, April, 1961, No. 64, eff. 5-1-61.

**Ind 42.26 Code constructed vessels.** Second hand pressure vessels which were constructed and stamped according to some edition of the A.S.M.E. Boiler and Unfired Pressure Vessel Code or other recognized pressure vessel codes may be installed with the working pressure stamped on the vessel.

**History:** Cr. Register, April, 1961, No. 64, eff. 5-1-61.

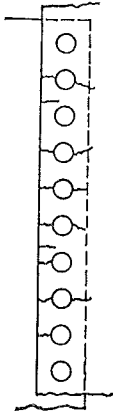
**Ind 42.27 Existing vessels.** Second hand boilers which were constructed and installed in Wisconsin under the provisions of sections Ind 41.60 through Ind 41.99 may be reinstalled if the working pressure is recalculated with a factor of safety of 6. Second hand unfired pressure vessels which do not meet the requirements of Ind 42.26 may be reinstalled if the working pressure is recalculated with a factor of safety of 6, using Ind 41.63 through Ind 41.65 and Ind 41.71 through Ind 41.75 for such calculations.

**History:** Cr. Register, April, 1961, No. 64, eff. 5-1-61.

Register, November, 1971, No. 191  
Boiler and Unfired Pressure Vessel Code

Fig. 8

CRACKS IN UNSTAYED SHELLS, DRUMS AND HEADERS



Fire Cracks at Girth Seams

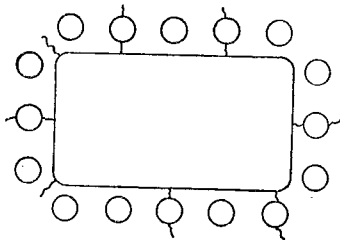
Prior to repairing fire cracks by welding, the rivets to which such cracks may extend and the rivets on each side of them shall be removed.

Tack bolts shall be placed in alternate holes to hold the plate laps firmly.

Cracks shall then be chipped, ground or gouged to produce required welding groove.

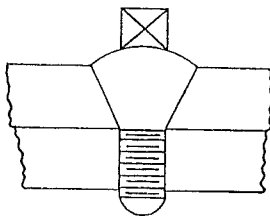
CRACKS WHICH EXTEND PAST THE INNER EDGE OF THE PLATE LAP SHALL BE WELDED FROM BOTH SIDES.

Rivet holes shall be reamed before new rivets are driven.



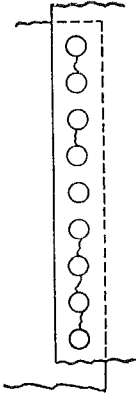
Fire Cracks at Door Openings

Repairs shall be made as for fire cracks at girth seams. Patch bolts may be used where it is not possible to redrive rivets.



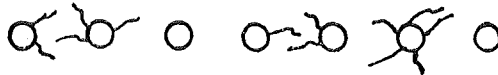
Patch Bolt

Fig. 8a

**CRACKS IN UNSTAYED SHELLS, DRUMS AND HEADERS****Circumferential Cracks at Girth Seams**

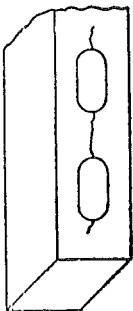
**Caution:** Before attempting repairs care shall be taken to investigate the cause of cracks of this type. Welding shall not be used if "caustic embrittlement" is indicated. Multiple or star cracks shall not be welded.

If repair by welding is authorized, method for repairing fire cracks at girth seams shall be used.

**Example of Multiple or Star Cracking****Cracks Between Tube Holes**

In repairing cracks of this type, welding shall be applied from both sides of the plate if possible.

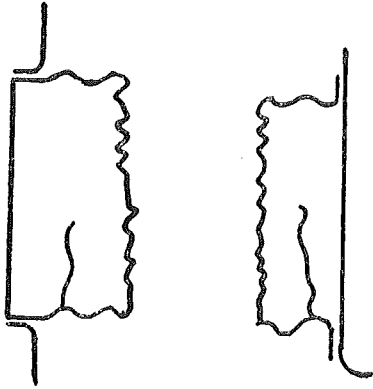
The tubes to which the cracks extend and the tubes on each side of them shall be removed and the cracks chipped, ground or gouged to provide the required welding groove. Tube holes shall be reamed before new tubes are installed.

**Cracks in Headers**

In repairing cracks of this type, welding may be applied from one side. A backing strip shall be used if possible to insure complete penetration at bottom of welding groove.

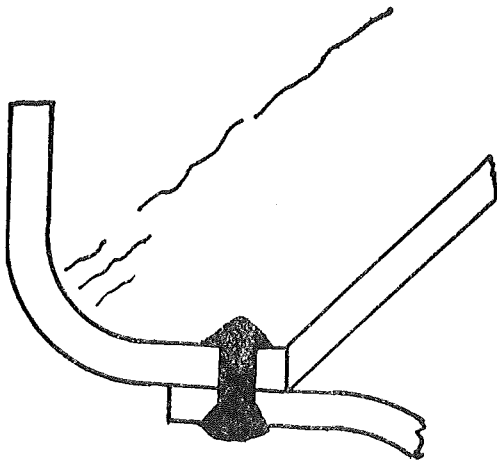


Fig. 9  
CRACKS IN UNSTAYED FURNACES



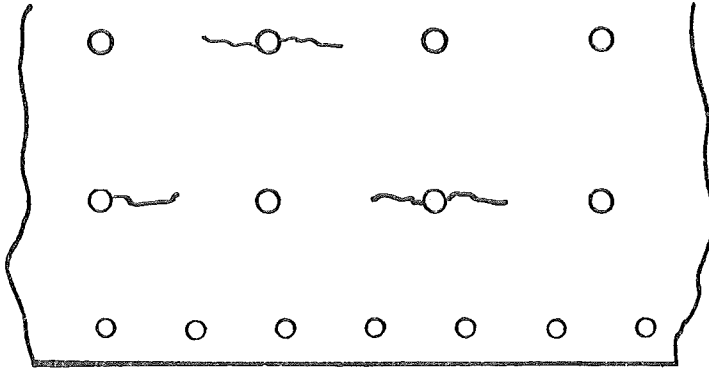
**Caution:** Successful performance of this repair requires a ductile weld free from slag inclusions, voids, cracks or other defects.

Cracks shall be chipped, ground or gouged to provide required welding groove; root of weld shall be cleaned by chipping or flame gouging and welding applied from both sides of the plate. Thermal stress relieving is recommended.



Field repair of cracks at knuckle or turn of flange of furnace opening is difficult. It is recommended that this repair be made in a well equipped shop.

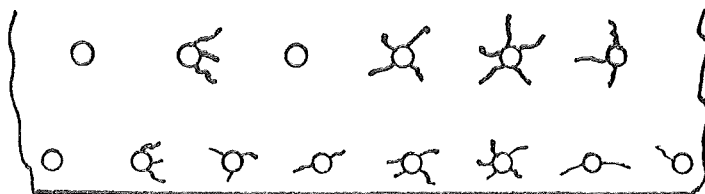
Fig 10  
CRACKS IN STAYED PLATES



**Caution:** Before attempting repairs to cracks of this type the inner surface of the plate shall be carefully examined for possible excessive corrosion or grooving.

Staybolts to which cracks may extend shall be removed and the cracks then chipped, ground or gouged to provide the required welding groove.

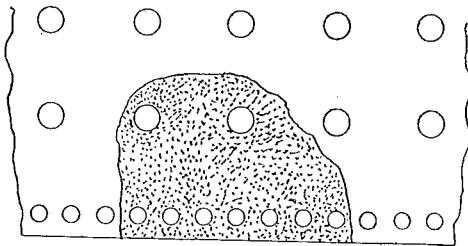
After welding, threaded staybolt holes shall be retapped and new staybolts properly driven and headed.



Multiple or star cracks radiating from staybolts or rivet holes shall not be repaired by welding.

Fig. 11

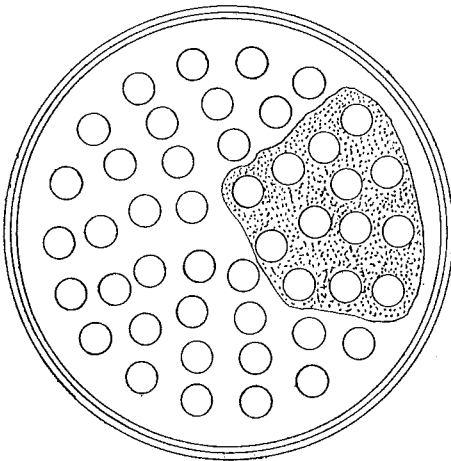
REINFORCING OF CORRODED AREAS IN STAYED PLATES



If corroded area includes rivets or staybolts, these shall be removed before welding is applied.

Threaded staybolt holes shall be retapped and rivet holes reamed before new staybolts are installed or rivets are driven.

*Note:* Welding shall not cover rivets or staybolt heads.



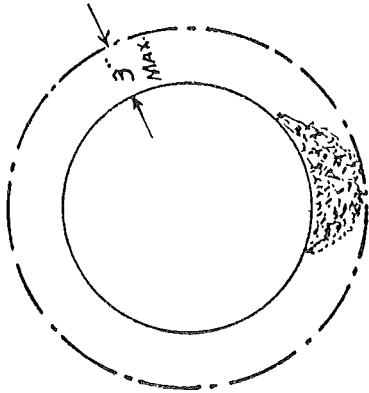
Corroded areas of tube sheets may be built up by welding where tubes act as stays.

All tubes in such corroded areas shall be removed before welding is applied.

After welding the tube holes shall be reamed before new tubes are installed.

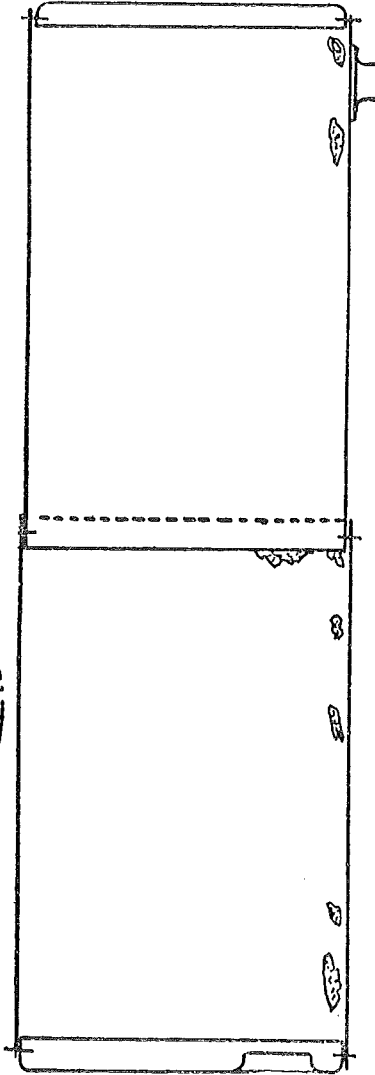
Fig. 12

CORRODED AREAS



Corroded Area around manhole or handhole openings.

Corroded area shall be thoroughly cleaned before welding.

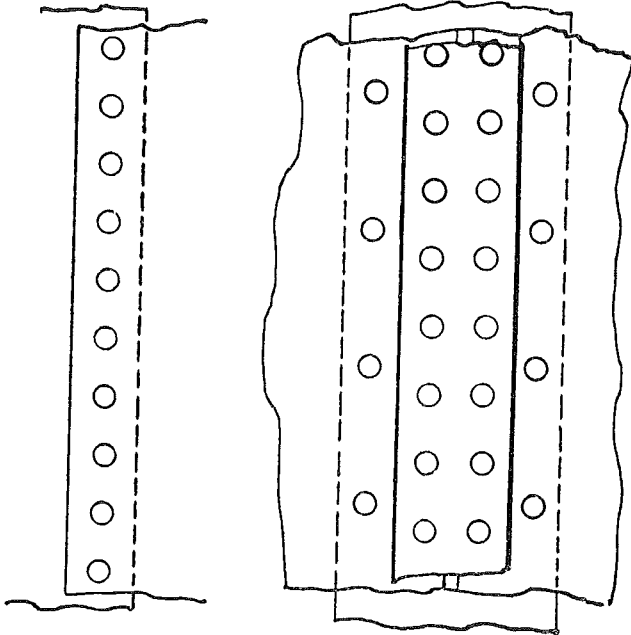


No corroded area which is shown in this sketch and which exceeds in size the permissible area of an unreinforced opening or exceeding in average depth 50% of the plate required thickness shall be "built up" by welding. Largest areas in vessels which are subject to internal corrosion or erosion but where the required thickness would be satisfactory for the pressure, can be built up under this rule.



Fig 13

SEAL WELDING OF CAULKING EDGES



**Caution.**—Seal welding shall not be applied if cracks are present in riveted areas.

Indications of persistent or recurring leakage may be a sign of cracking. No welding shall be applied until a careful examination—including removal of rivets if necessary—has been made of such areas. Seal welding shall be applied in one light layer if practicable but not more than two layers shall be used.

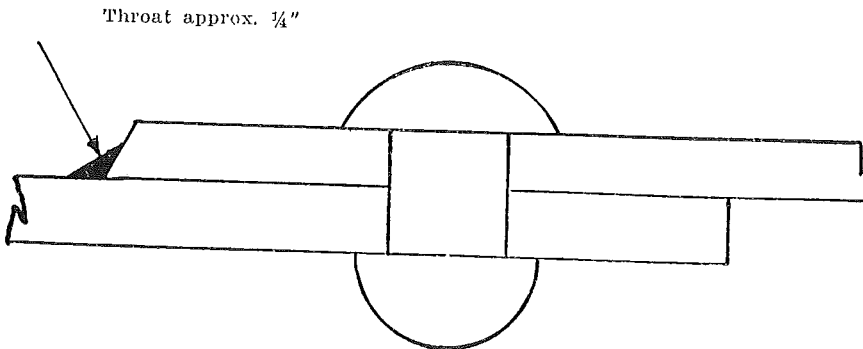
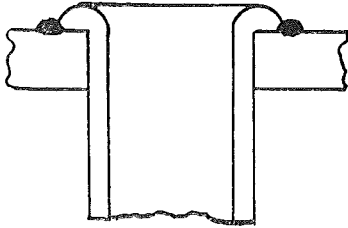
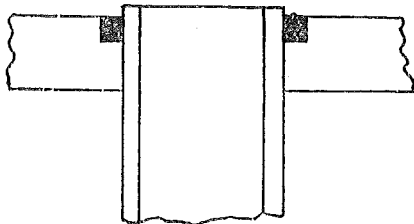
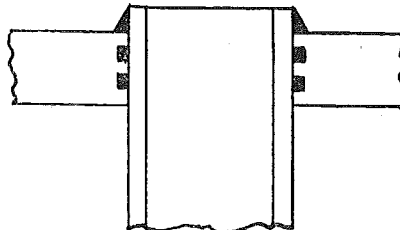
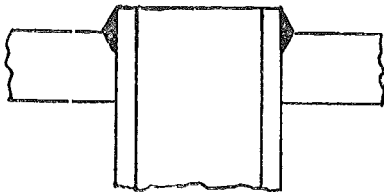
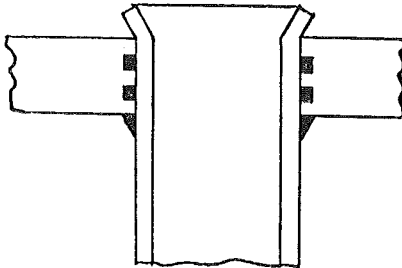
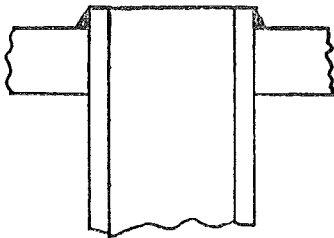


Fig 14

## SEAL WELDING OF TUBE ENDS



Seal welding shall be applied in one light layer if practicable but not more than two layers shall be used—Throat dimension shall not exceed  $5/16$ ".



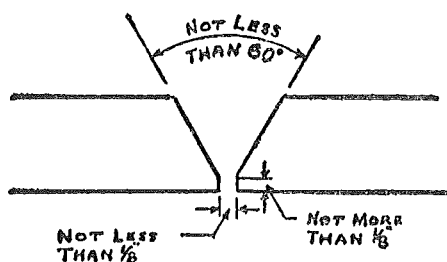
In water tube boilers, tubes may be seal welded on inside or outside of tube sheet.

Flaring may be omitted if tube ends are seal welded.

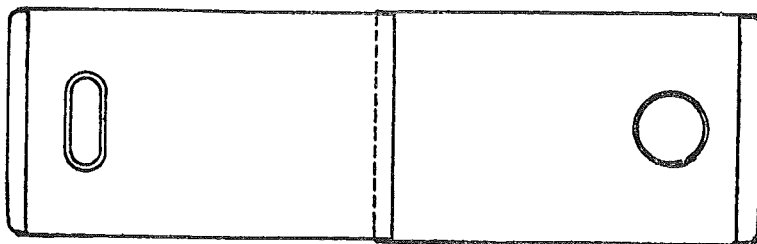
In fire tube boilers requirements of section Ind 41.50 and Ind 41.51 of this code shall be complied with.

Fig 15

FLUSH OR BUTT WELDED PATCHES IN UNSTAYED AREAS



Accepted Detail of Weld



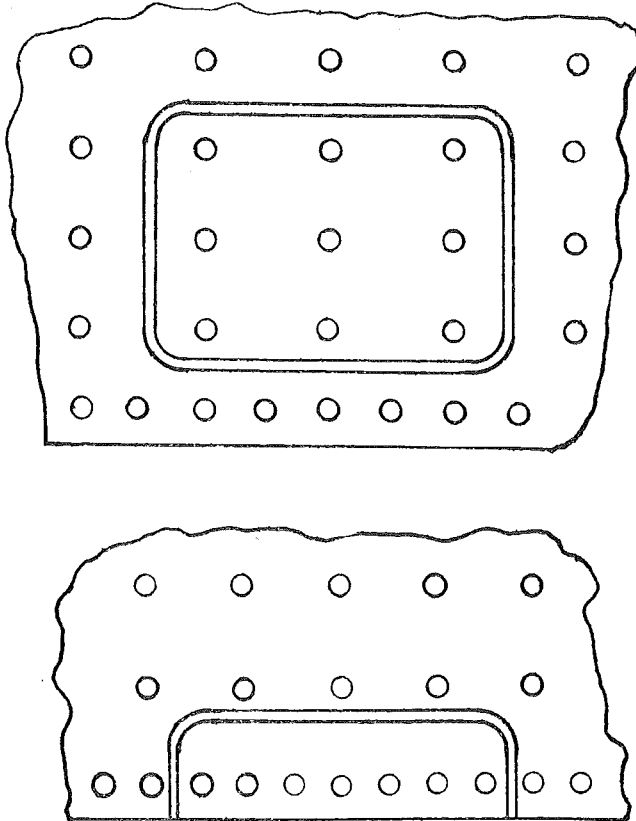
Before any effort is made to patch a bagged or deformed area the original shape or curvature shall be restored as far as possible. Patch shall be rolled or pressed to proper shape or curvature. Edges shall align without overlap.

Flush or butt welded patches may be of any shape, an adequate radius shall however be provided at corners if patch is rectangular. Sharp corners shall be avoided.

*Note:* Patches shall be of material equal to the original construction in thickness and quality.

Fig. 16

## FLUSH OR BUTT WELDED PATCHES IN STAYED AREAS



Patches shall be of material equal to the original in quality and thickness. Before applying patches of this type, defective metal shall be cut away until sound material is reached.

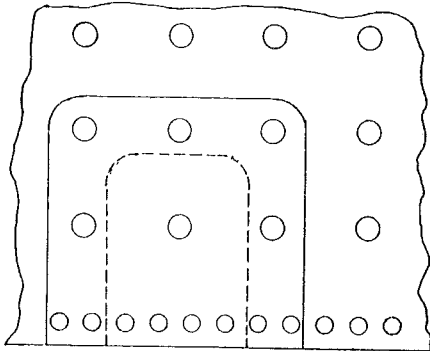
Patch seams shall come between staybolt rows or riveted seams.

In applying patches of this type, square corners shall be avoided. Ample radius shall be provided at corners.



Fig. 17

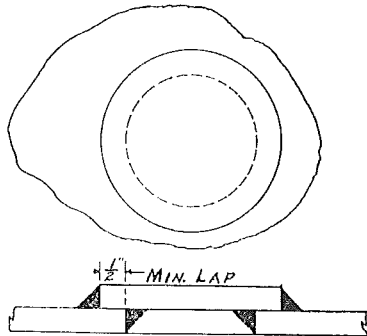
LAP-FILLET WELDED PATCHES



Patches shall be of material equal to the original in quality and thickness.

If area to be patched includes a riveted seam rivets shall be removed before patch is applied and new rivets driven before patch is welded at edges.

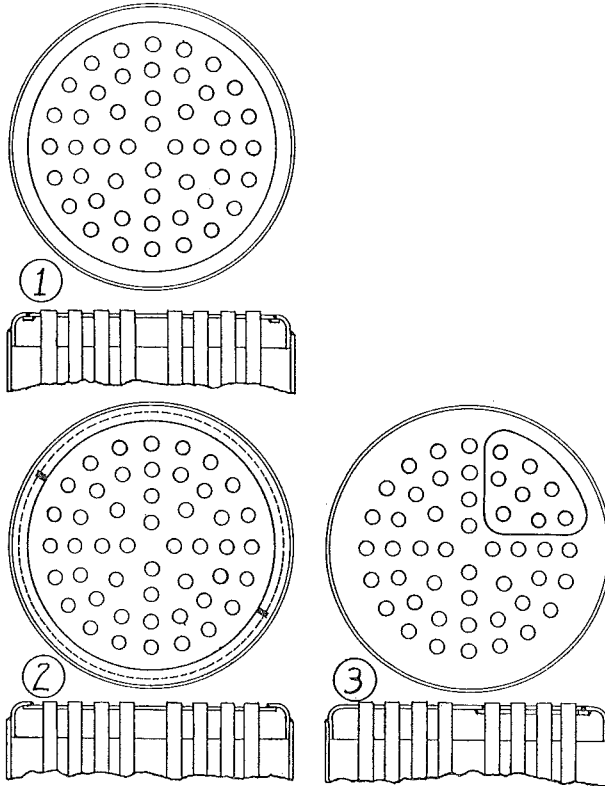
New staybolts shall be installed in patched area, the heads of staybolts shall not be covered by welding.



Lap Fillet Welded Patch in Unstayed Area

Fig. 18

**ACCEPTABLE REPAIRS FOR CORRODED OR WORN HEADS OF  
VERTICAL TUBE OR SIMILAR TYPE BOILERS**



**1. Flush Butt Welded Head**

With this repair the old head is cut close to the point of tangency of the knuckle of the flange and the new head, previously drilled for tube holes and beveled for adequate welding groove is butt welded to flanged section of old head. Pack up ring, inserted in sections if necessary, shall be used to insure weld penetration for full head thickness.

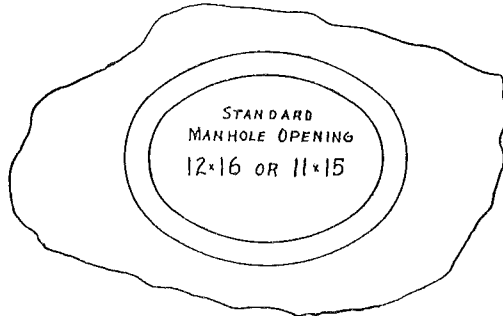
**2. Lapped and Fillet Welded Head**

With this repair, the new head is lapped under the flange knuckle of old head, previously slotted as shown to admit new head, then fillet welded at edge.

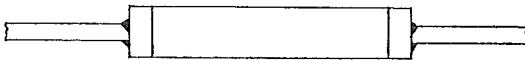
**3. Segmental or Pie-Shaped Butt Welded Patch**

Fig. 19

ACCEPTED REPAIRS FOR INSPECTION OPENINGS



A badly corroded manhole flange may be repaired by cutting out flanged section and inserting a ring type frame as shown. Dimensions shall comply with requirements of sections Ind 41.50 and Ind 41.51 of this code.



Ring type frame may be fabricated and stress relieved in shop then welded in place.  
Rules for flush patches shall be complied with.

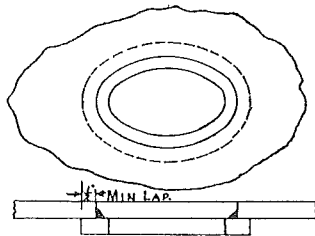


Plate lap should not be less than  $\frac{1}{2}$ ".  
When corrosion has reduced thickness of plate around handhole opening by more than 50% (average) a reinforcing ring shall be used as shown placed on the inside.

Fig. 20

**SUGGESTED FURNACE RENEWAL**

Longitudinal seam in furnace double butt-welded and thermally stress-relieved. For repair, final joint to each head may be stress-relieved by peening. Furnace may be welded into a riveted boiler by using adaptable end closures. Ringed furnace shall be thermally stress-relieved after longitudinal seam and rings have been applied.

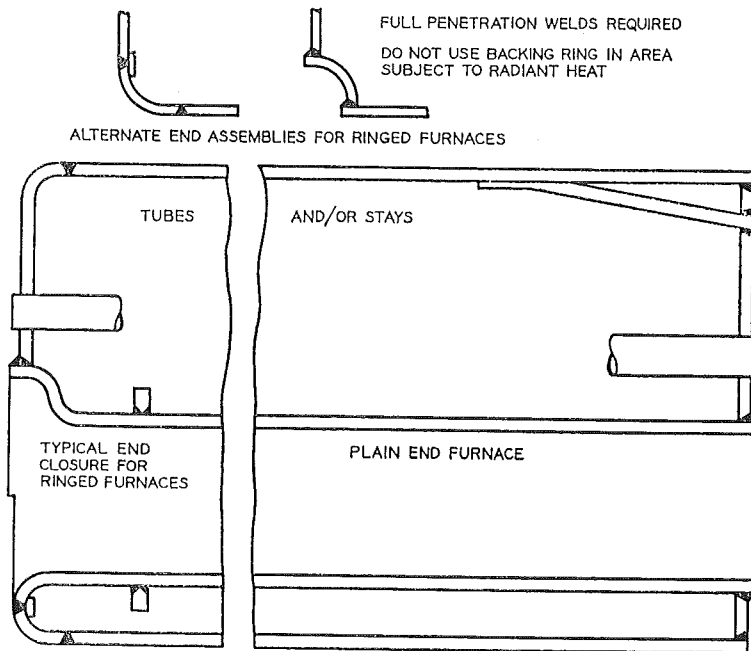
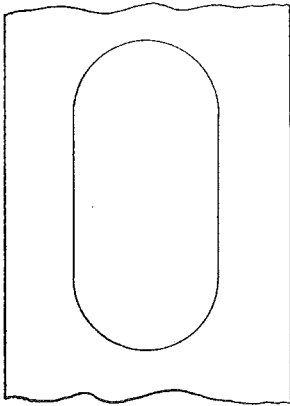


Fig. 20 SUGGESTED FURNACE RENEWAL

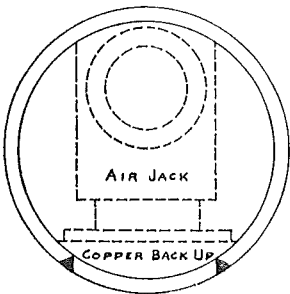
Fig. 21

ACCEPTED "WINDOW" PATCH FOR WATER TUBE  
BOILER TUBES



This type of patch may be used if necessary to seal a hole cut in a water wall tube to provide access for welding the back side of a circum. joint or to replace a small sharp bag.

Window patches shall comply with provisions of sections Ind 41.50 and Ind 41.51 of this code. Patch shall be cut from tube of same size and thickness as the one being repaired.



When practicable, a removable copper backup recessed as shown to provide complete weld penetration through the tube wall and held in place by a removable air jack shall be used during the welding operation.

**Ind 42.28 Vessels from other states.** Second hand pressure vessels previously operated in other states shall meet the requirements of section Ind 42.26.

**History:** Cr. Register, April, 1961, No. 64, eff. 5-1-61.

**Ind 42.29 Lap seam boilers.** Second hand boilers which have lap seam construction and which are larger than 36 inches in diameter shall be limited to a maximum allowable working pressure of not more than 15 pounds per square inch.

**History:** Cr. Register, April, 1961, No. 64, eff. 5-1-61.

**Ind 42.30 Prohibited boilers.** The installation of second hand boilers which have the longitudinal joint exposed to the intense heat of the furnace is prohibited.

*Note.* The locomotive or inside welt strap will not be considered as strengthening or changing the original type of boiler joint.

**History:** Cr. Register, April, 1961, No. 64, eff. 5-1-61.

**Ind 42.31 Inspection and testing.** (1) Every second hand boiler and unfired pressure vessel shall be inspected and given a hydrostatic pressure test at 1½ times the working pressure by an authorized inspector at its new point of installation location before it is placed in operation, except for the following:

(a) Vessels used for the storage and transportation of liquefied petroleum gases or anhydrous ammonia.

(b) Vessels containing more than 2,000 gallons of refrigerant.

(2) The vessels excluded in subsection (1) may be acceptable for use provided a copy of the manufacturer's data sheet is furnished to the industrial commission for each vessel indicating that it was manufactured originally to the requirements of section Ind 41.50. If a vessel has been repaired since its fabrication, a copy of the new manufacturer's data report shall be furnished to the industrial commission.

(3) For unfired pressure vessels where a hydrostatic test, in the opinion of the industrial commission, is not possible or desirable, the industrial commission may accept alternate means to determine the safety of the vessel for its intended use.

**History:** Cr. Register, April, 1961, No. 64, eff. 5-1-61; am. Register, January, 1966, No. 121, eff. 2-1-66.

**Ind 42.32 Installation.** All second hand pressure vessels exclusive of vessels used for the storage and transportation of liquefied petroleum gases, anhydrous ammonia, and all refrigerant containing vessels when re-installed shall comply with the A.S.M.E. codes listed in section Ind 41.50 in regard to fittings, appliances, valves, connections, settings and supports. (The excluded vessels are subject to the provisions of other applicable administrative codes.)

**History:** Cr. Register, April, 1961, No. 64, eff. 5-1-61.

**Ind 42.33 Portable boilers.** A portable boiler, when brought into this state for use, shall be given the inspection and test specified in section Ind 42.31 and the allowable working pressure shall be calculated using sections Ind 41.60 through Ind 41.99 unless it meets either of the following requirements:

(1) The boiler was constructed and stamped according to section Ind 42.26 code constructed vessels.

(2) The boiler is insured by a boiler insurance company.

**History:** Cr. Register, April, 1961, No. 64, eff. 5-1-61.

Register, November, 1971, No. 191  
Boiler and Unfired Pressure Vessel Code

PART IX

INSPECTION AND REPAIR OF UNFIRED PRESSURE VESSELS  
IN PETROLEUM REFINERIES

**Ind 42.35 Application.** Sections Ind 42.35 through Ind 42.63 shall apply to the inspection, repair, evaluation for continued use, and the methods for computing the maximum allowable working pressure of unfired pressure vessels in petroleum refineries.

**History:** Cr. Register, April, 1961, No. 64, eff. 5-1-61.

**Ind 42.36 Inspection; general.** (1) Vessels that are inspected in accordance with the procedures described herein will be acceptable, however, other procedures approved by the industrial commission may be used.

(2) New vessels shall be permitted to operate within the conditions for which they were constructed as determined in section Ind 42.40 or, in cases where the provisions of section Ind 42.39 (1) (c) apply, for an initial period during which corrosion rates are determined as specified in section Ind 42.39 (1) (c).

(3) If the vessel is to be kept in service the allowable conditions of service and the length of time before the next inspection shall be based on the condition of the vessel, as determined by the inspection.

(4) If the allowable working pressure and temperature are changed, the period of operation until the next inspection shall be established for this new service.

(5) If both the ownership and location of any vessel are changed, the vessel shall be inspected before it is re-used and the allowable conditions of service and the next period of inspection shall be established for the new service.

**History:** Cr. Register, April, 1961, No. 64, eff. 5-1-61.

**Ind 42.37 Qualifications of inspectors.** Inspectors shall be at least 25 years of age and shall have at least 3 years experience in boiler or unfired pressure vessel construction or repair or operating engineer in charge of high pressure boilers, or an inspector of steam boilers or unfired pressure vessels. Technical education with a recognized degree of mechanical engineering shall be allowed 2 years as the equivalent of practical experience.

**History:** Cr. Register, April, 1961, No. 64, eff. 5-1-61.

**Ind 42.38 Inspection records.** (1) A permanent and progressive record shall be maintained for each vessel. This record shall include the following:

- (a) Manufacturer's and owner's serial numbers.
- (b) Location and thickness for critical points at all inspections.
- (c) Limiting metal temperature and location on vessel, if such temperature is below -20 F., or is a factor in establishing the allowable working pressure or other service conditions for the vessel.
- (d) Computed maximum allowable working pressure at the time of the next inspection and coincident temperature,\* and, in addition, if

\* For a vessel designed for more than one combination of operating conditions, i.e., having more than one maximum allowable working pressure with coincident temperatures, or for a vessel in which different zones are subjected to different temperatures (see section Ind 41.50), all conditions should be recorded.

the vessel is rated by a code other than the one to which it was constructed, computations showing method of determining the maximum allowable working pressure with reference to the specific edition of the code or codes used.

(e) Hydrostatic test pressure if so tested at the time of inspection.

(f) Scheduled (approximate) date of next inspection.

(g) Date of installation and of any significant change in service conditions (pressure, temperature, character of contents, or rates of corrosion), for any vessels of the types mentioned in section Ind 42.38 (2) (b).

(2) In addition to the progressive vessel record described in section Ind 42.38 (1), a file which contains the following information shall be maintained:

(a) Complete safety valve data, including spring data, and date of latest inspection.

(b) For all vessels used in process operations and others subject to corrosive conditions, drawings giving sufficient details to permit calculation of service rating of all components.

**History:** Cr. Register, April, 1961, No. 64, eff. 5-1-61.

**Ind 42.39 Determination of probable corrosion rate.** (1) On new vessels and on vessels for which service conditions are being changed, one of the following methods shall be employed to determine the probable rate of corrosion from which the remaining wall thickness at the time of the next inspection can be estimated:

(a) The corrosion rate as established by accurate data collected by the owner or user on vessels in the same or similar service.

(b) If accurate data for the same or similar service are not available, the probable corrosion rate as estimated from the inspector's knowledge and experience on vessels in similar service.

(c) If the probable corrosion rate cannot be determined by either of the above mentioned methods, thickness determinations shall be made after approximately 1,000 hours of service, or one normal run if longer than this; subsequent sets of thickness measurements shall be taken after additional similar intervals until the corrosion rate is established. If the probable corrosion rate is determined by this method, the corrosion data indicated by the first inspection may be used as a first approximation of the corrosion rate, but shall be excluded from all subsequent computations of the corrosion rate, since attack on the initial surfaces may not be indicative of subsequent attack on corroded surfaces.

**History:** Cr. Register, April, 1961, No. 64, eff. 5-1-61.

**Ind 42.40 Maximum period between inspections.** (1) When the contents of a vessel are known to be, or expected to be, corrosive, the maximum period between internal inspections shall not exceed  $\frac{1}{2}$  of the estimated remaining safe operating life of the vessel, or 5 years, whichever is less; except in cases where an adequate inspection history extending over a period of at least 5 years has established that the corrosion rate is reasonably uniform and predictable, the interval between the current inspection and the next subsequent one may be established as the projected full remaining safe operating life of the vessel, provided this projected period does not exceed one year.

(2) In cases where part or all of the vessel wall has a protective lining, the frequency of inspections for the portions of the vessel so



protected shall be determined from a consideration of records of previous experience with the protection afforded by the lining during similar operations (and the corrosion allowance for the protected metal if there is any likelihood that the lining will fail), but the maximum period between internal inspections shall not exceed 5 years.

(3) When a vessel has 2 or more zones of considerable extent and the net discarding thicknesses, corrosion allowances, or corrosion rates for each differ so much that the foregoing provisions give significant differences in maximum periods between inspections for the respective zones (e.g., the upper and lower portions of some fractionating towers), the periods between inspections may be established individually for each zone on the basis of the conditions applicable thereto, instead of being established for the entire vessel on the basis of the zone which requires the more frequent internal inspection.

(4) The "net discarding thickness" for a vessel or zone, as referred to above, shall be understood to mean the large of the following:

(a) The net wall thickness, exclusive of any corrosion allowance, required for the safety valve setting and operating temperature for the service in which the vessel is being used, or

(b) The minimum practical thickness permitted by the provisions of section Ind 41.50.

(5) When the contents of a vessel are known to be non-corrosive, the vessel need not be inspected internally as long as it remains in the same service and provided all the following conditions are met:

(a) The non-corrosive character of the contents (including the effect of trace components) shall have been established by at least 5 years comparable service experience with the fluid which is being handled.

(b) No questionable condition is disclosed by the annual external examinations required by section Ind 42.40 (7).

(c) The operating temperature of the vessel contents does not exceed 500 F. for ferrous metals, or 250 F. for non-ferrous metals.

(d) The vessel is so installed that the contents are not subject to inadvertent contamination by corrosives.

(6) When the contents of a vessel are expected to be non-corrosive, but one or more of the conditions of section Ind 42.40 (5) is not met, the maximum period between inspections shall not exceed 5 years, or such shorter interval as may be deemed necessary if some kind of deterioration other than corrosion is anticipated or suspected.

(7) In addition, all vessels aboveground shall be given a visual external examination at least once every 12 months, preferably while in operation, to determine the readily apparent condition of the vessel, its supports, and exterior insulation, as well as the general alignment of the vessel on its supports, which might indicate external loadings affecting the vessel's condition.

(8) The safety and relief valve equipment shall be inspected and tested at intervals as necessary to maintain the equipment in a safe operating condition. The intervals between inspections should be determined by experience in the particular service concerned. Other pressure relieving devices, such as rupture disks, shall be given a thorough examination at intervals determined on the same basis.

(9) The periods for inspection referred to in this section assume that the vessel is in continuous operation, interrupted only by normal shut-down intervals. If the vessel is out of service for an extended interval, the effect of such a non-operating period shall be considered in revis-

ing the date of the next inspection which was established and reported at the time of the previous inspection. If the vessel is out of service for a continuous period of one year or more, it shall be given an inspection before again being placed in service.

**History:** Cr. Register, April, 1961, No. 64, eff. 5-1-61.

**Ind 42.41 Inspection for corrosion.** (1) The minimum thickness and maximum corrosion rate for any part of the vessel shall be determined at each inspection specified in section Ind 42.40 by methods such as described in the following paragraphs:

(a) The depth of corrosion in vessels subjected to corrosion service may be determined by gaging from uncorroded surfaces within the vessel, when such surfaces are available and suitably located with respect to the area in question. These surfaces may be obtained by either of 2 methods:

1. Protecting the normal surface with welded corrosion-resistant strips or buttons which can be removed during inspection; or,

2. By using such strips or buttons as reference levels from which to measure if the strips or buttons are fully corrosion-resistant and if accelerated corrosion does not occur adjacent to the strips or buttons.

(b) When corrosion-resistant strips or buttons cannot be used, it may be practical to drill small holes from the corrosion-susceptible surfaces, before corrosion starts, at suitable intervals to a depth equal to the metal thickness allowed for corrosion, and to plug these holes with protective material that can be readily removed to determine from time to time the loss in metal thickness as measured from the bottom of these holes.

(c) When the depth of corrosion cannot be readily determined otherwise, holes may be drilled through the portions of the wall where corrosion appears to be a maximum, and the thickness determined by taking thickness-gage measurements through these holes. If suitably located existing openings are available, such measurements may be taken through these openings.

(d) Any other suitable method (such as ultrasonic or gamma-ray instruments) that will not affect the safety of the vessel may be used provided it will assure minimum thickness determinations accurate within the following tolerances:

<u>Wall Thickness, t</u>	<u>Permissible Tolerance</u>
$\frac{1}{8}$ in. and less	0.10t
Over $\frac{1}{8}$ in.	$\frac{1}{8}$ in., or 0.05t, whichever is greater.

(2) For a corroded area of considerable size in which the circumferential stresses govern, the least thicknesses along the most critical element of such area may be averaged over a length not exceeding:

(a) The lesser of  $\frac{1}{2}$  the vessel diameter, or 20 in., in the case of vessels with inside diameters of 60 in. or less; or

(b) The lesser of  $\frac{1}{3}$  the vessel diameter, or 40 in., in the case of vessels with inside diameters greater than 60 inches—except that if the area contains an opening, the distance within which thicknesses are averaged on either side of such opening shall not extend beyond the limits of reinforcement as referred to in section Ind 41.50. If, because of wind loads or other factors, the longitudinal stresses would be of importance, the least thicknesses in a similarly determined length of arc in the most critical plans perpendicular to the axis of

the vessel also shall be averaged for computation of the longitudinal stresses. The thicknesses used for determining corrosion rates at the respective locations shall be the average thicknesses determined as aforesaid; and for the purposes of section Ind 42.48 "the actual thickness as determined by inspection" shall be understood to mean the most critical value of average thickness so determined.

(3) Widely scattered pits may be ignored provided their depth is not more than  $\frac{1}{2}$  the net thickness of the vessel wall (exclusive of corrosion allowance), the total area of the pits does not exceed 7 sq. in. within any 8-in. diameter circle, and the sum of their dimensions along any straight line within this circle does not exceed 2 inches.

**History:** Cr. Register, April, 1961, No. 64, eff. 5-1-61.

**Ind 42.42 Correction of corrosion rate.** If, upon measuring the wall thickness at any inspection, it is found that an inaccurate rate of corrosion has been assumed, the rate to be used for the next period shall be increased or may be decreased to conform with the actual rate found.

**History:** Cr. Register, April, 1961, No. 64, eff. 5-1-61.

**Ind 42.43 Inspection for defects.** (1) The parts of a vessel which should be inspected most carefully depend upon the type of vessel and the operating conditions to which it is subjected. The inspector should be familiar with the operating conditions of the vessel and with the causes and character of defects and deterioration that may result therefrom.

(2) Among the many ways of inspecting a vessel for defects, careful visual examination is by far the most important and the most universally applicable. Other means that may be very useful from time to time include magnetic-particle inspection (for cracks and other elongated discontinuities in magnetic materials), fluorescent or dye penetrants (for disclosing porosity, pinholes, etc., which extend to the surface of the material and for outlining other surface manifestations, especially in non-magnetic materials), hammer testing, pressure testing, exploratory chipping, etc. All of these methods should be considered as auxiliary to careful visual examination. The extent to which one or more of them should be used in any given case can be determined only by the exercise of mature judgment based upon the details of circumstances encountered. Adequate surface preparation is frequently of paramount importance to proper visual examination and to the satisfactory application of any auxiliary procedure such as those mentioned above. The extent to which special surface preparation may be required is dependent upon the individual circumstances involved, but may require wire brushing, sandblasting, chipping, or grinding, or a combination of these operations in addition to routine cleanings.

(3) If it is found that external or internal coverings, such as insulation, refractory protective linings, corrosion-resistant linings, etc., where they exist are in good condition and there is no reason to suspect any unsafe condition behind them, usually it is not necessary to remove them for inspection of the vessel. In such cases, however, it sometimes may be advisable to remove small portions of the coverings in order to investigate their condition and effectiveness and the condition of the metal back of them. Where operating deposits, such as coke, normally are permitted to remain on a vessel surface, it is particularly important to determine whether such deposits adequately

protect the vessel surface from deterioration; this may require thorough removal of the deposit in selected critical areas for spot-check examination. Where vessels are equipped with removable internals, these internals need not be completely removed provided reasonable assurance exists that deterioration in regions rendered inaccessible by them is not occurring to an extent that might constitute a hazard or to an extent beyond that found in more readily accessible parts of the vessel.

(4) The items that normally shall be examined during an inspection, subject in each case to the provisions of section Ind 42.43 (3) and various suggestions concerning some of the things to be looked for, or procedures that may be used, are as follows:

(a) *Shells and heads.* Examine surfaces carefully for possible cracks, blisters, bulges, and other evidences of deterioration giving particular attention to the knuckle regions of the heads. If evidence of distortion is found, it may be advisable to make a detailed check of the actual contour against the design shape even though this may require removal of insulation or internal protective linings. On vessels with torispherical (dished) heads, if no record exists as to the crown radius and knuckle radius of the heads, these dimensions should be ascertained and recorded even though no evidence of distortion is observed.

(b) *Joints.* Examine inner and outer surfaces of welded joints carefully for possible cracks and for other defects such as may have been uncovered by the progress of corrosion. Magnetic-particle inspection is suggested as a useful means for doing this either throughout the lengths of the welds or as a supplement to visual inspection on selected lengths which may appear to need more than a visual inspection. Examine riveted joints inside and outside of the vessel for the condition of rivet heads, butt straps, and plates, and for the condition of the calked edges.

(c) *Manways, nozzles, and other openings.* Examine the surfaces of all manways, nozzles, and other openings carefully for distortion, cracks, and other defects giving particular attention to all welding or riveting used for attaching such parts and their reinforcements. If drawings are not available which show details of opening reinforcements and their attachments, take such measurements on these components as may be needed for computing the adequacy thereof. If any question exists as to the condition of any threaded connections, the threaded parts should be disassembled to permit a careful check of the number of threads that remain effective and in good condition. Examine accessible flange faces for distortion and for the condition of gasket seating surfaces.

(5) The inspection items given above are not presumed to be complete for every vessel, but include those features common to most vessels and in general those of greatest importance. Inspectors must supplement this list with any additional items necessary for the particular vessel or vessels involved.

**History:** Cr. Register, April, 1961, No. 64, eff. 5-1-61.

**Ind 42.44 Check of dimensions.** The vessels shall be examined for visible indication of distortion; if any such distortion is suspected or observed, the over-all dimensions of the vessels shall be checked to determine the extent and seriousness of the distortion.

**History:** Cr. Register, April, 1961, No. 64, eff. 5-1-61.

Register, November, 1971, No. 191  
Boiler and Unfired Pressure Vessel Code

**Ind 42.45 Pressure relief devices.** The safety valves and other protective devices, such as rupture disks and vacuum valves, where used, should be checked to see that they are in proper condition. This inspection, in the case of valves, will normally include a check on their operation at the set pressure, a check that the proper spring is installed for the service, and an examination to determine that inlets, outlets, and discharge piping are free of corrosion products or other stoppage.

**History:** Cr. Register, April, 1961, No. 64, eff. 5-1-61.

**Ind 42.46 Temperature measuring devices.** Temperature measuring devices used for determining metal temperatures shall be checked for accuracy and general condition.

**History:** Cr. Register, April, 1961, No. 64, eff. 5-1-61.

**Ind 42.47 Allowable operation based on inspection data.** Defects or damage discovered during the inspection shall be repaired in accordance with section Ind 42.50 through section Ind 42.63, or shall constitute a basis for reducing the allowable working pressure in accordance with section Ind 42.48, or, as a final resort, for retiring the vessel from service.

**History:** Cr. Register, April, 1961, No. 64, eff. 5-1-61.

**Ind 42.48 Allowable working pressure.** (1) The allowable working pressure for the continued use of a vessel may be established by the code to which the vessel was built or by computation using the appropriate formulas in the latest edition of the A.S.M.E. Code listed in section Ind 41.50 if all essential details (such as quality of materials and workmanship, knuckle radii of heads, reinforcement of openings, etc.) definitely are known to comply with the latter. In corrosive service the actual thickness as determined by inspection minus twice the estimated corrosion loss before the date of the next inspection shall be used, except as modified in section Ind 42.40 (1). Suitable allowance shall be made for the other loadings in accordance with section Ind 41.50.

(2) For vessels with riveted joints, in which the strength of one or more of the joints is a governing factor in establishing the maximum allowable working pressure, consideration shall be given to whether, and to what extent, corrosion will change the possible modes of failure through such joints. Also, even though no additional thickness may have originally been provided for corrosion allowance at such joints, credit may be taken where computations show this to be justified, for the corrosion allowance inherent in the joint design.

(3) The allowable working pressure of vessels with one or more openings, for which the closures are auxiliary equipment not part of the pressure vessel, shall be determined only after due consideration of any pressure limitations imposed by such auxiliary equipment.

**History:** Cr. Register, April, 1961, No. 64, eff. 5-1-61.

**Ind 42.49 Pressure test.** (1) Unless required by section Ind 42.49 (2), a pressure test normally need not be made as a part of a periodic inspection. However, one shall be made when unusual, hard-to-evaluate forms of deterioration possibly affecting the safety of the vessel are disclosed by inspection (and after certain repairs, see section Ind 42.63). When a pressure test is made for this purpose, it shall be conducted at a pressure determined in accordance with the provisions of section Ind 41.50.

(2) Any vessel that has not previously been given a hydrostatic test at a pressure of 1.50 times its maximum allowable pressure as referred to in section Ind 41.50, or a pneumatic test at a pressure of 1.10 times the maximum allowable pressure, shall be given a hydrostatic pressure test at the time of each inspection at a pressure not less than 1.50 times its design pressure, or a pneumatic test not less than 1.10 times the design pressure, suitable correction being made in either case for differences in temperature between design and test conditions. Vessels whose main joints are 100% radiographed are exempted from this requirement.

**History:** Cr. Register, April, 1961, No. 64, eff. 5-1-61.

**Ind 42.50 Field repairs; general.** No repairs, additions, or alterations shall be made until the proposed methods of execution have been considered and approved by the inspector. Other methods may be used if submitted to and approved by the industrial commission. All such work shall be of the highest quality of workmanship, and shall be executed in a manner and by practices complying with the applicable provisions of section Ind 41.50, and with code approved materials and under proper supervision. Complete records of all such work shall be made and filed.

**History:** Cr. Register, April, 1961, No. 64, eff. 5-1-61.

**Ind 42.51 Defects in welded joints and plates.** Repairs to cracks found in welded joints and to minor defects found in plates may be made, after preparing a U or V-shaped groove the full depth and length of the crack, by filling this groove with weld metal deposited in accordance with the requirements of section Ind 42.57, or by riveting a reinforcing plate which meets the requirements of section Ind 41.50 for a hole equal in diameter to the full length of the crack after chipping out or drilling the ends.

**History:** Cr. Register, April, 1961, No. 64, eff. 5-1-61.

**Ind 42.52 Corrosion pits.** Isolated corrosion pits may be filled with weld metal deposited in accordance with the requirements of section Ind 42.57. Such pits shall be cleaned to sound metal before welding.

**History:** Cr. Register, April, 1961, No. 64, eff. 5-1-61.

**Ind 42.53 Thickness gage holes.** (1) In corroded vessels subject to rapid stress fluctuations, the holes drilled through the vessel wall for measuring thickness in accordance with section Ind 42.41 shall be closed by welding which complies with section Ind 42.57 and provides complete penetration and fusion for the full depth of the hole.

(2) For vessels in other service, these holes may be treated as unreinforced openings and may be closed by any method permitted under the rules of the A.S.M.E. code.

**History:** Cr. Register, April, 1961, No. 64, eff. 5-1-61.

**Ind 42.54 Corroded or distorted flange faces.** (1) Corroded flange faces may be cleaned thoroughly and built up with weld metal deposited in accordance with the requirements of section Ind 42.57 and re-machined in place, if possible, to a thickness not less than that of the original flange or that required by calculations in accordance with the rules in section Ind 41.50. Corroded flanges may also be re-machined in place, without building up with weld metal, provided the metal removed in the process does not reduce the thickness of the flange below that calculated as above.

(2) Warped flanges which cannot be re-machined, or flanges which have become distorted because of excessive tightening of bolts, shall be replaced with new flanges which have at least the dimensions conforming to section Ind 41.50, welded on in accordance with the requirements of section Ind 42.57.

**History:** Cr. Register, April, 1961, No. 64, eff. 5-1-61.

**Ind 42.55 Cracks at tapped openings.** (1) It is not recommended to repair a crack at a tapped opening by chipping, welding, and re-tapping.

(2) Instead of making a repair as mentioned in (1) a fully reinforced flanged nozzle may be installed, or if a tapped connection is required, it may be provided by welding in a heavy-wall, 3000# minimum threaded coupling by one of the methods permitted in section Ind 41.50.

**History:** Cr. Register, April, 1961, No. 64, eff. 5-1-61.

**Ind 42.56 Inadequate bolting material.** Defective bolting material shall be replaced with suitable material which meets the requirements of section Ind 41.50.

**History:** Cr. Register, April, 1961, No. 64, eff. 5-1-61.

**Ind 42.57 Field welding.** (1) Strength welding shall be done by qualified welders and shall meet all other requirements of section Ind 41.50.

(2) Preheating to not less than 300 F. may be considered as an alternative to thermal stress relief for minor alterations or repairs of initially stress relieved vessels constructed of the P-1 carbon steels listed in section Ind 41.50 and for the P-3 alloy steels preheat sometimes can be considered as an alternative, especially when the operating temperature is high enough to assure reasonable ductility of the weldment during operation, and there is no excessive hazard during hydrostatic tests. Vessels constructed of other steels, which initially were required to be stress-relieved normally, shall be stress-relieved if alterations or repairs involving strength welding are performed. Any stress relieving shall be performed in accordance with section Ind 41.50. When preheat is used as an alternative for thermal stress relief as provided above, the stress relief factor may be continued.

**History:** Cr. Register, April, 1961, No. 64, eff. 5-1-61.

**Ind 42.58 Applying patches to vessels by welding.** (1) Patches to be welded to vessel walls shall be made of material equivalent to the material of the plate to be repaired. If a flush patch is to be installed in a vessel with welded longitudinal joints, a type of joint shall be used which has a joint factor (efficiency) as high as the original longitudinal joint. If a flush patch is to be installed in a seamless section, a double welded butt joint shall be made.

(2) If a lap patch is applied, welding shall be performed in the same manner as for a reinforcing plate around an opening, and the proportions of the patch shall be determined as outlined in section Ind 41.50. The application of patch plates to both the outside and inside of the vessel wall sometimes is preferred to a single lap plate. (Such double patch plates should be avoided in high temperature service; in hydrogen blistering service a weep hole should be provided in one of the patch plates.) Lap patches attached by welding should not be applied to wall thicknesses over  $\frac{5}{8}$  inch.

(3) If a welded patch is applied to a riveted vessel, the type of welded joint used shall have at least as high an efficiency as the riveted longitudinal joint.

**History:** Cr. Register, April, 1961, No. 64, eff. 5-1-61.

**Ind 42.59 Riveting.** All field riveting shall meet the requirements of section Ind 41.50.

**History:** Cr. Register, April, 1961, No. 64, eff. 5-1-61.

**Ind 42.60 Applying patches to vessels by riveting.** The application of a riveted patch shall be made in conformity with the rules given in section Ind 41.50 for reinforcing plates attached by riveting.

**History:** Cr. Register, April, 1961, No. 64, eff. 5-1-61.

**Ind 42.61 New connections.** (1) New connections may be installed on vessels provided the design, location, and method of attachment meet the construction requirements of the A.S.M.E. code.

(2) Welding shall conform to the requirements of section Ind 42.57 and riveting to the requirements of section Ind 42.59.

**History:** Cr. Register, April, 1961, No. 64, eff. 5-1-61.

**Ind 42.62 Calking riveted vessels.** Riveted joints may be made tight either by mechanical calking or by metallic arc seal welding in accordance with Ind 41.50 after carefully cleaning the seam and cleaning around the rivet heads.

**History:** Cr. Register, April, 1961, No. 64, eff. 5-1-61.

**Ind 42.63 Pressure test after repairs.** A vessel, which has had repairs or alterations, shall be given a pressure test in accordance with section Ind 42.49 (2), provided the inspector deems it necessary.

**History:** Cr. Register, April, 1961, No. 64, eff. 5-1-61.