

## Chapter H 62

**DESIGN, CONSTRUCTION, INSTALLATION,  
SUPERVISION, AND INSPECTION  
OF PLUMBING**

|         |                              |         |                                       |
|---------|------------------------------|---------|---------------------------------------|
| H 62.01 | Basic plumbing principles    | H 62.14 | Special requirements                  |
| H 62.02 | Definitions                  | H 62.15 | Materials                             |
| H 62.03 | Fixture unit design basis    | H 62.16 | Joints and connections                |
| H 62.04 | House sewers                 | H 62.17 | Repairs and reconstruction            |
| H 62.05 | House drains                 | H 62.18 | Water supply systems                  |
| H 62.06 | Stacks and branches          | H 62.19 | Back siphonage and cross connections  |
| H 62.07 | Vents                        | H 62.20 | Sewage treatment and disposal systems |
| H 62.08 | Traps                        | H 62.21 | Inspection and tests                  |
| H 62.09 | Cleanouts                    | H 62.22 | Sketches                              |
| H 62.10 | Floor drains                 | H 62.23 | Industrial commission regulations     |
| H 62.11 | Catch basin, sumps, ejectors |         |                                       |
| H 62.12 | Fixtures                     |         |                                       |
| H 62.13 | Rain water connections       |         |                                       |

**H 62.01 Basic plumbing principles.** (1) All premises intended for human occupation or occupancy shall be provided with a supply of pure and wholesome water; such supply shall not be cross connected with an unsafe water supply nor with a waste pipe.

(2) Buildings in which water closets and other plumbing fixtures exist shall be provided with a supply of water adequate in volume and pressure for flushing purposes.

(3) The pipes conveying water to water closets shall be of sufficient size to supply the water at a rate required for adequate flushing without unduly reducing the pressure at other fixtures.

(4) Devices for heating water and storing it in "boilers", or hot water tanks, shall be so designed and installed as to prevent all dangers of explosion, and also prevent backflow of hot water through a meter connected with a public water supply.

(5) Every building intended for human habitation or occupancy on premises abutting on a street in which there is a public sewer shall have a connection with the sewer.

(6) In multiple dwellings provided with a house drainage system, there shall be at least one private water closet for each family.

(7) Plumbing fixtures shall be made of smooth nonabsorbent material, shall be free from concealed fouling surfaces, and shall be set free of inclosures.

(8) The entire house drainage system shall be so designed, constructed, and maintained as to conduct the waste water or sewage quickly from the fixture to the place of disposal, with velocities which will prevent clogging, fouling and the depositing of solids.

(9) The drainage pipes shall be so designed and constructed as to be proof for a reasonable life of the building against leakage of water or drain air due to defective materials, imperfect connections, corrosion, settlements or vibrations of the ground or building, temperature changes, freezing or other causes.

(10) The drainage system shall be provided with an adequate number of cleanouts so arranged that in case of stoppage the pipes may be readily accessible.

(11) Each fixture or combination fixture shall be provided with a separate accessible, self scouring reliable water seal trap placed as near to the fixture as practical.

(12) The house drainage system shall be so designed that there will be an adequate circulation of air in all pipes, no danger of siphonage, aspiration, or forcing of trap seals under conditions of ordinary use.

(13) The soil stack shall extend full size, upward through the roof terminal and have a free opening, the roof terminal being so located that there will be no danger of air passing from it to any window and no danger of clogging of the pipe by frost, or by articles being thrown into it, or of roof water draining into it.

(14) The plumbing system shall be subjected to a water or air pressure test, and to a final air pressure test if necessary, to disclose all leaks and imperfections in the work.

(15) No substances which will clog the pipes, produce explosive mixtures, or destroy the pipes or their joints, shall be allowed to enter the house drainage system.

(16) Refrigerators, ice boxes, or receptacles for storing food shall not be connected directly with the drainage system.

(17) No water-closet or urinal shall be located in a room or compartment which is not properly lighted or ventilated to the outer air.

(18) If water-closets or other plumbing fixtures exist in buildings where there is no sewer within a reasonable distance, suitable provision shall be made for disposing of the house sewage by some method of sewage treatment and disposal satisfactory to the health authority having jurisdiction.

(19) Where a house drainage system may be subjected to backflow of sewage, suitable provisions shall be made to prevent its overflow into the building.

(20) Plumbing systems shall be maintained in a sanitary condition.

**H 62.02 Definitions.** (1) **PLUMBING** means and includes: (a) All piping, fixtures, appliances and appurtenances in connection with the water supply and drainage systems within a building and to a point from 3 to 5 feet outside of the building.

(b) The construction and connection of any drain or waste pipe carrying domestic sewage from a point within 3 to 5 feet outside of the foundation walls of any building with the sewer service lateral at the curb or other disposal terminal, including private domestic sewage treatment and disposal systems and the alteration of any such system, drain or waste pipe, except minor repairs to faucets, valves, pipes, appliances and removing of stoppages.

(c) The water service piping from a point within 3 to 5 feet outside of the foundation walls of any building to the mains in the street, alley or other terminal and the connecting of domestic hot water storage tanks, water softeners, and water heaters with the water supply system.

(d) The water pressure system other than municipal systems as provided in ch. 144.

(e) A plumbing and drainage system so designed and vent piping so installed as to keep the air within the system in free circulation and movement, and to prevent with a margin of safety unequal air

pressures of such force as might blow, siphon or affect trap seals, or retard the discharge from plumbing fixtures, or permit sewer air to escape into the building.

(2) ALIGNMENT. Laid to a straight line, either horizontal, vertical or at a given angle.

(3) APPROVED means approval by the local plumbing or building supervisor or state board of health or industrial commission in conformance with the respective laws and regulations governing.

(4) A.S.T.M. Abbreviation for American Society for Testing Materials.

(5) BACKFLOW is a term which denotes the reversal of flow in a drainage system.

(6) BASEMENT means a story whose floor line is below grade at any entrance or exit and whose ceiling is not more than 5 feet above grade at any such entrance or exit. The first floor is the floor next above the basement, or the lowest floor is there is no basement. The number of stories of a building includes all stories except the basement.

(7) BELL OR HUB. That portion of a pipe which for a short distance is sufficiently enlarged to receive the end of another pipe of the same diameter for the purpose of making a joint.

*Am 3/10/57*  
 (8) BRANCH. The branch of any system of piping is that part of the system, which extends horizontally at a slight grade, with or without lateral or vertical extensions, from the stack, to receive fixture outlets not directly connected to the stack.

(9) BURR. Roughness or metal protruding from the walls of a pipe, usually as the result of cutting the pipe.

(10) CATCH BASIN. A water-tight receptacle built to arrest the sediment of surface subsoil or other waste drainage, and to retain oily or greasy wastes, to prevent their entrance into the house sewer or drain.

(11) CLEANOUT. A metallic plug or cover joined by means of a screw thread to an opening in a pipe, which can be removed for the purpose of cleaning or examining the interior of the pipe.

(12) CODE. A compilation of minimum rules and regulations governing the installation of plumbing, drainage and water supply.

(13) CONDUCTORS, ROOF LEADERS, DOWN SPOUTS. All pipes located in or outside of buildings, conveying storm or rain water from the roofs of buildings or areas to the storm or yard sewer, basin or rain-water cistern.

(14) DEAD END is that part or branch of a drainage system which is without a free circulation of air.

(15) DRAINAGE DISPOSAL FIELD. A shallow soil absorption system consisting of open jointed or perforated pipe for disposal of effluent or clear waste.

(16) EFFLUENT. Liquid flowing from any treatment tank or device.

(17) **EJECTORS.** An ejector is a device operated either electrically, or by water power or other mechanical means so constructed as to elevate liquids from a lower level to a point of discharge into a public or private sewer or other final means of disposal.

(18) **FERRULE.** A metallic sleeve, used to connect lead or iron waste, or vent pipe, to a soil pipe hub.

(19) A **FITTING** is a device designed to make connections between pipes.

(20) **FIXTURES.** (a) A *fixture* is a receptacle intended to receive and discharge water, liquids, or water carried wastes into a drainage system.

(b) A *lavatory* or wash basin is a fixture designed for the washing of the hands or face.

(c) A *sink* is a shallow fixture ordinarily with a flat bottom, and usually used in a kitchen, or in connection with the preparation of foods.

(d) *Service sink* is a deeper fixture than a kitchen sink and used for the reception of slops.

(e) A *tray* is a fixture used in a laundry for washing; sometimes called a laundry tub.

(21) **FIXTURE UNIT** is any fixture or equivalent that discharges intermittently at the rate of 7.5 gallons per minute (one cubic foot per minute).

(22) **FREE CIRCULATION** of air means a plumbing and drainage system so designed and installed as to keep the air within the system in free circulation and movement, and to prevent with a margin of safety unequal air pressures of such force as might blow, siphon or affect trap seals, or retard the discharge from plumbing fixtures or permit sewer air to escape into the building.

(23) **GARAGES.** A public garage is a building or part of a building having more than 500 square feet in area which accommodates or houses self-propelled land, air or water vehicles.

(24) **HEIGHT OF BUILDING** is measured at the vertical center line of its lowest side from the street grade, or if setting back from street from grade of the ground adjoining the building, to the highest part of a flat roof or to a point two-thirds the height of a gabled or hip roof.

(25) **INDUSTRIAL WASTES.** The liquid wastes resulting from the processes employed in industrial establishments.

(26) **LONG SWEEP  $\frac{1}{4}$  BEND.** A bend having the radius of the center line of the bend equal to 7 inches plus one-half the inside diameter of the pipe.

(27) **MANHOLE.** An opening constructed to a sewer or any portion of a plumbing system of sufficient size, to permit a man to gain access thereto.

(28) **PLACE OF EMPLOYMENT.** Every place, whether indoors or out, or underground and the premises appurtenant thereto, where either temporary or permanently any industry, trade or business is carried

on, or where any process or operation, directly or indirectly related to any industry, trade or business, is carried on, and where any person is directly or indirectly employed by another for direct or indirect gain or profit, but shall not include any place where persons are employed in private domestic service or agricultural pursuits, which do not involve the use of mechanical power.

(29) PRIVATE DWELLING is understood in this code to be any building used only for living purposes and occupied by not more than two families.

(30) PRIVY. An outhouse or structure used for the deposition of human excrement.

(31) PRIVY VAULT. A pit beneath a privy in which human excrement collects.

(32) PUBLIC BUILDING. Any structure used in whole or in part as a place of resort, assemblage, lodging, trade, traffic occupancy or use by the public, or by three or more tenants.

(33) REPAIRS AND STOPPAGES. Repairs are defined to consist of fixing leaks and removing of obstructions in soil, waste and supply pipes and to restore defective valves, faucets and similar appliances to an efficient operating condition.

(34) RISER is a water-supply pipe which extends vertically one full story or more to convey water to branches or fixtures.

(35) ROUGHING IN is the installation of all soil, waste, vent and water supply pipes within a building.

(36) RURAL OR ISOLATED BUILDINGS are understood in this code to be those situated at such a distance from a public sewer system that their drainage systems cannot become tributary thereto.

(37) SAFING. A pan or other collector placed beneath a pipe or fixture, to prevent leakage from escaping on the floor, ceiling or walls.

(38) SEEPAGE PIT. An underground receptacle with a manhole and cover brought to the surface of the ground for observation and cleaning purposes, so constructed as to insure the disposal of effluent or clear wastes, by soil absorption through its walls and bottom.

(39) SEPTIC TANK is a reservoir or tank which receives crude sewage, and by bacterial action and sedimentation effects a process of clarification and decomposition of solids.

(40) SEWAGE. The water carried wastes created in and to be conducted away from residences, industrial establishments, and public buildings as defined in section 101.01, Wis. Stats., with such surface or ground water as may be present.

(41) SEWERAGE SYSTEM. All structures, conduits and pipe lines by which sewage is collected and disposed of, except plumbing inside and in connection with buildings served, and service pipes from building to street main.

(42) SEWERS. (a) A *combined sewer* is a sewer or drain intended to receive domestic sewage, industrial water-carried wastes, surface, storm and clear water.

(b) *House drain* is the lowest main horizontal piping of a drainage system which receives the discharge of all soil, waste and other drainage pipes inside any building and conveys the same to the house sewer, 3 to 5 feet outside the foundation wall of such building. The minimum house drain extends from the house sewer to the furthest-most soil, waste or vent stack. *Ann*

(c) A *house sewer* is that part of the horizontal piping beginning three feet from the foundation wall to its connection with the main sewer, septic tank, or other disposal terminal. *Ann 3*

(d) A *private sewer* is a privately owned sewer.

(e) A *public sewer* is a publicly owned sewer.

(f) A *sanitary sewer* is a sewer or drain constructed to convey organic waste from buildings to a septic or other treatment tank or point of disposal and from which all surface and storm water is excluded.

(g) A *storm drain* is a conduit for carrying off surface, storm and clear waters.

(h) A *subsoil drain* is that part of a drainage system which conveys the ground or seepage water, from the foot of walls or below the cellar floor under buildings to the house or storm drain.

(i) A *yard drain* is that part of a horizontal piping and its branches which convey the surface drainage from areas, courts or yards, outside the walls of a building, to the house drain, house sewer or storm water drain.

(43) SHALL, SHOULD, AND MAY. The word "shall" when used in this code is mandatory. "Should" is not mandatory but expresses the recommendation of the board. "May" implies neither compulsion nor recommendation, only permission.

(44) SIPHONAGE. (a) *Siphonage* is a suction created by the flow of liquids in pipes.

(b) *Back siphonage* means the formation of a partial vacuum in water supply pipes which cause a sucking back of polluted water or other liquids into the water supply piping.

(45) SLIP JOINT is a connection in which one pipe slips into another, the joint of which is made tight with approved gasket or packing.

(46) SOIL PIPE OR STACK is any pipe which conveys the discharge of water closets with or without other fixtures to the house drain. *Ann :*

(47) SPECIAL WASTE. Waste pipes which are not permitted to connect directly to the soil or waste stack, house drain or house sewer.

(48) SPIGOT is the end of a pipe or fitting which fits into bell or hub.

(49) STACK is a pipe extending vertically from the house drain, with or without change of direction through the roof or connecting back into another stack. *Ann*

(50) SUMP. A collecting basin installed at the low point of a plumbing system to receive liquid wastes from which they may be ejected or pumped to a gravity sewer or waste pipe.

(51) **TERMINAL** is that part of a drainage or vent system which projects above the roof of the building or at the end of the house drain connecting to the septic tank or house sewer.

(52) **TRAPS.** (a) *Trap* is a fitting constructed to prevent the passage of air or gas through a pipe without materially affecting the flow of sewage or waste water.

(b) The *crown of a trap* is where the trap connects to or becomes a part of the horizontal outlet arm, and any portion of the horizontal outlet arm of the trap which is integral with the trap.

(c) *Deep seal* is a term applied to a trap having a water seal twice the depth of the common trap.

(d) *Depth of trap seal* is indicated by the height of the water column measured between the overflow and the dip separating the inlet and outlet arms of the trap.

(e) A *deep seal resealing trap* of the centrifugal self-scouring type is a trap in which the water motion is both centrifugal and upward at each discharge of the fixture and retains an adequate amount of water to form an efficient trap seal.

(f) A *drum trap* consists of a cylinder with its axis vertical. The cylinder is larger in diameter than the inlet or outlet pipe, it is usually 4 inches in diameter with one and one half or 2 inch inlets and outlets. A trap screw of the same size as the cylinder, accessible for cleaning purposes is provided.

(g) A *sand trap* is a catch basin for the collection of sand or other gritty material.

(53) A **VACUUM** is a pressure less than atmospheric pressure and is referred to sometimes as a suction. It is usually measured by the number of inches of mercury below atmospheric pressure, such as 10 or 20 inches of mercury. A perfect vacuum varies with the barometric pressure but in Wisconsin is equal to about 29 inches of mercury.

(54) **VENTS.** (a) *Vent pipe* is any pipe provided to ventilate a drainage and plumbing system of piping.

(b) *Back vent* is a pipe which connects directly with an individual trap, soil or waste pipe underneath or back of the fixture it serves and connects to the general vent piping system above this fixture with no part of it below the fixture trap.

(c) *Branch vent* is that part of the vent piping which extends horizontal, with or without lateral or vertical extensions, and to which other vent pipes connect.

(d) *Circuit vent* is a connection made by joining a nearly horizontal trap outlet with a soil or waste pipe, and vent pipe in such a manner that a continuous vent is formed.

(e) *Continuous vent* is a vertical vent pipe that is a continuation of the vertical waste pipe to which it connects.

(f) *Loop vent* is similar to a back vent except that part of it extends below the trap it serves before re-connecting to the vent system.

(g) *Main soil or waste vent* is that part of the stack above the highest installed branch or fixture connection.

(h) *Main vent* is a vent pipe extending vertically with or without changes of direction and which acts as a terminal for other vents, and terminates through the roof or connects with the main soil or waste vent at a point 2 feet or more above the highest soil or waste opening, but in no case less than 38 inches above the highest floor on which soil or waste openings are installed.

(i) *Relief vent* is a vent pipe connected close to the stack in a manner to prevent minus and plus pressures in the stack.

(j) *Unit vent* is one which denotes an installation so arranged that one pipe will serve two traps at the same point.

(k) *Wet vent* is that portion of a vent pipe through which liquid wastes flow.

(l) *Yoke vent*. A connection between a vent stack and a soil or waste stack in a manner to prevent minus and plus pressures in the stacks.

(m) *Local or exhaust vent* is a pipe or shaft conveying foul air from plumbing fixtures or rooms to the outside air and not connected to the plumbing system.

(55) WASTE STACK OR PIPE AND LOCAL WASTE PIPE is any pipe which receives the discharge of any fixture except water closets. When such pipe does not connect directly with a house drain or soil stack it is called a local waste pipe.

(56) WATER SUPPLY. (a) A *private water supply* is a privately owned supply not including any public utility or any water supply serving ten or more premises of mixed ownership.

(b) The *water service pipe* is the pipe from the water main, or private pumping system to the building served.

(c) The *water distribution pipes* are those which convey water from the service pipe to the plumbing fixtures.

(57) WIPED JOINT is the fusion of metal with solder, smoothly finished with a wiping cloth, and having a thickness of at least one-fourth inch, at the point where the pipes are joined.

(58) WORKMANSHIP is work of such character that will fully secure the results sought in all the sections of this code.

**H 62.03 Fixture unit design basis.** (1) INTERMITTENT FLOW FIXTURES. The fixture unit value and the size of traps, vents, and piping shall be as designated in the following table for any fixture named therein. Equivalent value for other intermittent operating fixtures shall be one fixture unit for each 7.5 gallons per minute of flow rate.

(2) CONTINUOUS FLOW FIXTURES. Fixtures such as pumps, ejectors and compressors from which there is continuous or semi-continuous discharge shall have a fixture value of two for each one gallon per minute of flow.



| Type of Fixture                   | Unit Value | Trap Minimum Size Inches | Soil or Waste Minimum Size Inches | Vent Minimum Size Inches |
|-----------------------------------|------------|--------------------------|-----------------------------------|--------------------------|
| Bath Tub, all types*.....         | 3          | 1½                       | 1½                                | 1½                       |
| Bed Pan Washer.....               | 6          | 2                        | 3                                 | 2                        |
| Bidet.....                        | 4          | 2                        | 2                                 | 1½                       |
| Cuspidor, fountain or dental..... | 1          | 1¼                       | 1¼                                | 1¼                       |
| Dishwasher, residential.....      | 4          | 1½                       | 1½                                | 1½                       |
| Drinking Fountain.....            | ½          | 1¼                       | 1¼                                | 1¼                       |
| Floor Drain,                      |            |                          |                                   |                          |
| 2 inch.....                       | 4          | 2                        | 2                                 | 1½                       |
| 3 inch or larger**.....           | 4          | 3                        | 3                                 | 2                        |
| Laundry Tray.....                 | 3          | 1½                       | 1½                                | 1½                       |
| Refrigerator, ice.....            | ½          | 1¼                       | 1¼                                | 1¼                       |
| Shower Stall, each head.....      | 4          | 2                        | 2                                 | 1½                       |
| Sinks,                            |            |                          |                                   |                          |
| combination.....                  | 4          | 1½                       | 1½                                | 1½                       |
| factory wash-up.....              | 4          | 2                        | 2                                 | 1½                       |
| fountain or bar.....              | 3          | 1½                       | 1½                                | 1½                       |
| glass or silver.....              | 3          | 1½                       | 1½                                | 1½                       |
| pack or plaster work.....         | 4          | 2                        | 2                                 | 1½                       |
| residential.....                  | 4          | 1½                       | 1½                                | 1½                       |
| restaurant, all types.....        | 4          | 2                        | 2                                 | 1½                       |
| siphon jet.....                   | 4          | 3                        | 3                                 | 2                        |
| service sink, wall outlet.....    | 4          | 2                        | 2                                 | 1½                       |
| service sink, floor outlet.....   | 4          | 3                        | 3                                 | 2                        |
| surgeons wash-up.....             | 3          | 1½                       | 1½                                | 1½                       |
| Sterilizer,                       |            |                          |                                   |                          |
| bed pan.....                      | 4          | 2                        | 2                                 | 1½                       |
| instrument or water.....          | 1          | 1¼                       | 1¼                                | 1¼                       |
| Urinal.....                       | 4          | 2                        | 2                                 | 1½                       |
| Wash basin.....                   | 1          | 1¼                       | 1½                                | 1¼                       |
| Water Closet, any type.....       | 6          | 2                        | 3                                 | 2                        |

\*Includes foot, Sitz and infant baths and regular bath tubs with or without shower  
 \*\*Trap and waste pipe sizes to correspond to floor drain when 4 inches or larger.

(3) UNIT CAPACITY AND LENGTH OF SANITARY PIPING. The number of fixture units connected to any stack, branch or vent and the length of piping shall not exceed that shown in the following table for a given diameter of pipe. After maximum length, including vent, for any given pipe size is reached, the diameter of the pipe shall be increased to the next size.

| Pipe Diameter (inches) | Fixture Unit Capacity<br>Soil, Waste or Vent Pipe |           |         | Maximum Length (in feet) |
|------------------------|---|-----------|---------|--------------------------|
|                        | On Stack  | On Branch | On Vent |                          |
| 1¼.....                | 1   | 1         | 1       | 50                       |
| 1½.....                | 8   | 4         | 12      | 65                       |
| 2.....                 | 18  | 9         | 24      | 85                       |
| 2½.....                | 40  | 20        | 60      | 105                      |
| 3.....                 | 84*   | 42        | 126     | 212                      |
| 4.....                 | 252   | 126       | 252     | 300                      |
| 5.....                 | 680   | 340       | 680     | 390                      |
| 6.....                 | 1,380   | 690       | 1,380   | 510                      |
| 8.....                 | 3,600   | 1,800     | 3,600   | 750                      |
| 10.....                | 7,600   | 3,800     | 7,600   | -----                    |
| 12.....                | 12,000  | 6,000     | 12,000  | -----                    |

\*See H 62.06 (2) on water closet limitations.

**H 62.04 House sewers.** (1) PREMISES SERVED. The plumbing system of each new building, or a new plumbing system in an existing building, shall be entirely separate from and independent of that of any other building. Every building shall have an independent connection with a public or private sewer when available. Where a building stands in the rear of another on the same lot, the house drain from the front building may be extended to the rear building, private

garage or barn, and the whole will be considered as one house drain. See H 62.22 (1).

(2) MATERIALS. All house sewers shall be constructed of cast iron, vitrified clay or concrete pipe or other approved materials.

*Note:* See H 63.01 and H 63.02 for tentative approval of bituminous fiber and asbestos cement pipe.

(3) GRADE. House sewers shall, where possible, have a grade of one-fourth inch per foot or more. In no case shall the grade be less than one-eighth inch per foot. Where the main sewer in the street has sufficient depth, or where a lot is 3 feet or more above the established street grade line, the house sewer between the curb line and lot line or building may receive greater inclination than one-half inch per foot as may be provided for by local ordinance, or as in the judgment of the authorized supervisor is permissible.

(4) SIZE. (a) *Sanitary sewer.* The size of the house sewer connecting with a sanitary sewer shall be determined by the total number of fixture units tributary to such house sewer using the following table. The diameter of the house sewer shall be equal to or greater than that of the house drain.

| Diameter of pipe<br>(inches) | Fixture Units         |                       |                       |
|------------------------------|-----------------------|-----------------------|-----------------------|
|                              | 1/8" per ft.<br>grade | 1/4" per ft.<br>grade | 3/8" per ft.<br>grade |
| 4                            | 114                   | 150                   | 210                   |
| 5                            | 270                   | 370                   | 540                   |
| 6                            | 510                   | 720                   | 1,050                 |
| 8                            | 1,290                 | 1,860                 | 2,640                 |
| 10                           | 2,520                 | 3,600                 | 5,250                 |
| 12                           | 4,390                 | 6,300                 | 9,300                 |

(b) *Combination sewer.* The minimum size of a combination house sewer or drain shall be the same as that required for a sanitary sewer. The size of a combination sewer or drain shall be determined in the same manner as for a sanitary sewer, using the table in subsection (a) and converting the drainage area to equivalent fixture unit loads. For the purposes of computing the equivalent fixture load, each 10 square feet of roof or drained area in horizontal projection shall count as one fixture unit. Maximum roof areas tributary to vertical leaders shall be governed by the following table:

| Type of Roof   | Allowable Roof Area in Square Feet for<br>Given Size of Inside Leader |                      |                      |                      |                      |                       |
|--|---|----------------------|----------------------|----------------------|----------------------|-----------------------|
|  | 2 1/4"  | 3"                   | 4"                   | 5"                   | 6"                   | 8"                    |
| Roof covered with gravel, slag or similar material with incline 1/4" to 1' or less | 1,646   | 1,646<br>to<br>2,120 | 2,120<br>to<br>3,780 | 3,780<br>to<br>5,886 | 5,886<br>to<br>8,490 | 8,490<br>to<br>15,123 |
| Same with incline 1/2" to 1' or more and sawtoothed roofs                          | 1,220   | 1,220<br>to<br>1,767 | 1,767<br>to<br>3,150 | 3,150<br>to<br>4,905 | 4,905<br>to<br>7,075 | 7,075<br>to<br>12,602 |
| Metal, tile, brick, slate, or similar roofs of any incline                         | 976   | 976<br>to<br>1,414   | 1,414<br>to<br>2,520 | 2,520<br>to<br>3,924 | 3,924<br>to<br>5,660 | 5,660<br>to<br>10,082 |

*Note:* In view of the storm water separation programs that are underway in many communities it is strongly recommended that separate sanitary and storm water drains and sewers be installed for all buildings even though a combination street sewer is the only outlet available at this time.

(c) *Storm sewer.* The required size of storm water house sewers, storm water house drains and other lateral storm drains shall be determined on the basis of total drained area in horizontal projections of roofs, yards and other areas tributary to same. The size of storm drains (horizontal) should be at least one size larger than required for the vertical leader. The size of the vertical leader should be determined from the table in subsection (b).

(5) **ALIGNMENT.** All house sewers shall be laid in alignment between fittings. Any changes in grade or direction shall be made with proper wyes and curves or wyes and one-eighth bends. Clipping of pipe is prohibited. All house sewers shall be installed on undisturbed stable ground. Where such ground conditions do not exist, adequate substantial supports of permanent material shall be provided at intervals of 3 feet or less to prevent settling of piping.

(6) **CONNECTIONS TO MAIN SEWER.** When in accordance with measurements furnished by the local governing body, or its authorized representatives, the house connection is not found within 3 feet of the designated point, a short slant connection and one-eighth bend shall be used, set upon a carefully cut opening in the main sewer, the connection secured to insure permanency by ample cementing or grouting; or a length of the main sewer pipe shall be removed, and a "Y" connection inserted in its place to serve as the connection of the house sewer to the main sewer. Such connection or insertion shall be made under the supervision of the authorized representative of the municipality. See H 62.22 (2).

(7) **DRAIN ENDS AND CONNECTIONS GUARDED.** The ends of all sewer and drain pipes not immediately connected shall be securely closed so as to prevent the introduction of sand or earth. Where the sewer or drain is to be used temporarily for draining foundations during the erection of any building or for other purposes a catch basin shall be provided.

(8) **TRENCHING.** (a) *Inspection.* When found necessary for inspection purposes, all excavations necessary for the installation of a house drainage system, or any part thereof, shall be open trench work. Trenches shall be trimmed to uniform grade.

(b) *Back filling.* Due care shall be exercised in back filling to prevent breakage or settling of the house sewer or drain.

(9) **LIMITATION ON LOCATION.** The following minimum distances shall be maintained between house sewers or drains and water wells:

- (a) Sewers of cast iron pipe—leaded joints ..... 8 feet
- (b) Sewer of other materials than cast iron ..... 25 feet
- (c) Rain water drains or other clear water conductors .. 10 feet

*Note:* See H 62.11 (1), (6), H 62.20 (1) (c) and (2) (a) for permissible location of catch basins, sumps, septic tanks and sewage disposal units with respect to water wells. Also see Wisconsin well construction and pump installation code.

(10) **LIMITATIONS ON USE.** (a) *Drains discharging obnoxious liquids.* No person shall connect to a public sewer any drains or sewer through which is discharged any obnoxious or odorous liquids, gas, tar, grease, rags or any other substance likely to cause an obstruction, nuisance, explosion or tend to interfere with sewage treatment processes. See H 62.11 (5).

(b) *Storm and clear water connections prohibited.* Roof leaders, surface drains, ground water drains or other drains carrying large amounts of water tending to interfere with the treatment of sewage shall be connected wherever possible with a storm sewer, but they shall not be connected to house sewers which discharge into sanitary sewers. *Ann 2*

**H 62.05 House drains.** (1) **ELEVATION.** All house drains wherever possible shall be brought into the building underground, below the level of the basement floor. Where such drain leaves the building at a point above the basement floor, same shall be constructed of cast iron or type M hard temper copper pipe to a point 5 feet from the inside of the building foundation wall or to such additional distance as necessary to reach undisturbed stable ground. See H 62.22 (3). *Ann*

(2) **MATERIALS.** All house drains shall be constructed of vitrified clay, type M hard temper copper or cast iron pipe. The use of vitrified clay or copper pipe is permitted where there is a soil covering of 18 inches or more. Where the ground level is surmounted by a substantial cement floor a 12 inch covering is permitted. The material and installation of above ground house drains shall conform to H 62.05 (1). *Ann*

(3) **SIZE.** The size of house drains shall be determined by the number of fixture units tributary thereto. No house drain shall be less than 4 inches in diameter. Basement underfloor waste pipes serving only basement fixtures other than water closets shall be not less than 3 inches in diameter except that a 2 inch diameter pipe not to exceed 5 feet in length may be used. See H 62.04 (4) (a). Also H 62.10 (1). *Ann*

(4) **BACK FLOW VALVES.** The house drain when subject to back flow or back water at the time of installation shall be provided with adequate back water valves, installed to prevent interference with the flow of discharge of any conductor, rain water leader or other fixture, and be readily accessible for cleaning. Provisions for a free circulation of air shall be made.

(5) **OTHER REQUIREMENTS.** Installation of house drains shall also conform to H 62.04 (3), (5), (7), (8) and (9).

**H 62.06 Stacks and branches.** (1) **SOIL AND WASTE STACKS.** Every building in which plumbing fixtures are installed shall have a soil, waste or vent stack at least 3 inches in diameter extending through the roof with an increaser or frost proof housing. See H 62.07 (12), H 62.22 (4), (5), (6), (7).

(2) **SIZE.** The size of the stacks shall be determined by the number of fixture units connected thereto. If pitch or grade of a soil or waste branch is 45 degrees or more, the same unit capacities as for vertical stack will be permissible. A water closet may connect to a 3 inch stack through a 4 x 3 inch bend. Not more than two water closets shall be connected to a 3 inch soil stack. Not more than one water closet shall be connected to a 3 inch branch. Two water closets located back to back shall be connected to a 3 inch soil stack with a 3 x 3 inch double wye and one-eighth bends or similar fittings or fitting. A sanitary cross will not be permitted. All waste openings provided for future use shall be properly vented and sealed. See H 62.03 (1), (3). *Ann*

(3) **STACK CONNECTION AT BASE.** A long sweep one-fourth bend, two one-eighth bends, or a "Y" and one-eighth or one-sixth bend or its equivalent shall be used at the base of all soil and waste stacks. When such bend or fittings constitute the connection between a soil or waste stack and an underground house drain or branch of larger size than the soil or waste stack served, the increase shall be made above the floor unless a special approved fitting is used. See H 62.22 (8), (9).

(4) **MULTIPLE BUILDING STACKS.** Where more than one unit in a motel, cabin court or mobile home park are connected to the same sewer or drain, a minimum vent stack of 2 inches may be permitted in each unit when the total number of fixture units does not exceed the capacity of such 2-inch pipe, provided that a full sized 3-inch stack is installed in the uppermost unit or at the upper end of the sewer. In the latter case the stack shall have frost protection. See H 62.07 (12)(a).

(5) **BRANCHES.** (a) *Soil and waste extensions.* Any branch extending from a soil or waste pipe, running vertically, horizontally, or both, shall be carried full size to fixture connections and shall be vented or revented to conform with the provisions of H 62.03 (1) and (3). See H 62.22 (11), (12).

(b) **GRADE OF HORIZONTAL PIPES.** All horizontal drain, soil and waste pipes shall be run in practical alignment, and where possible at a uniform grade of one-fourth inch per foot or more. In no case shall the grade be less than one-eighth inch per foot.

(c) *Change in direction.* All changes in direction shall be made by the proper use of 45 degree "Y"s, half-"Y"s, long sweep one-fourth bends, one-sixth, one-eighth or one-sixteenth bends, or with fittings producing a like radius, except that single or double sanitary "T"s may be used on vertical stack or on horizontal runs where it is impracticable to install a 45 degree "Y" with a one-eighth bend. Short one-fourth bends may be used in soil and waste lines where the change in direction of flow is from the horizontal to the vertical and for closet discharge connections. No common pattern double sanitary "T", "Y" or straight through fitting shall be used on either a vertical or horizontal stack or branch, serving wall-hung closet bowls installed back to back. See H 62.06 (2), H 62.14 (10), H 62.15 (5) (a).

(6) **HANGERS AND SUPPORTS.** Stacks shall be substantially supported at 10 foot or floor intervals. Horizontal piping shall be supported at intervals not to exceed 10 feet. Cast iron soil pipe shall be supported at intervals of not more than 5 feet. All pipe supports shall be heavy iron posts, wall hangers or bracket, or concrete or masonry piers. Supports secured in or against masonry shall be attached with expansion bolts or other approved methods without the use of wood plugs. All drainage and plumbing pipes shall be rigidly secured and supported so that proper alignment will be retained. See H 62.22 (9).

(7) **INCREASERS AND REDUCERS.** Where different sizes of pipes or pipes and fittings are to be connected, proper size increasers or reducers shall be used.

(8) **MATERIALS.** All main branch, soil and waste pipes shall be made of cast iron, coated with tar or asphaltum, galvanized wrought iron or galvanized steel pipe, or lead, brass, or type M hard temper copper. All piping, other than cast iron pipe, when installed so as to be embedded through concrete, shall be protected by thoroughly applying one or more coats of asphaltum paint or adequate tar paper wrapping or both, or by other equivalent means of insulation. No galvanized steel or wrought iron waste pipes shall be laid underground.

(9) **PROTECTION FROM FROST.** All drain, soil, or waste pipes shall, unless entirely impracticable, be placed within the walls of buildings and shall be as direct as possible and shall together with all fixture traps and other appliances be protected from frost. Wherever soil and waste pipes are placed in outside walls, protection from frost shall be provided by adequate insulation which may consist of proper air spacing, approved insulating materials, warm air circulation or any effective combination of the same. The underfloor work of bath rooms located on outside walls, shall be protected from frost by the placing of cold air draft stops between joists or studdings, or by the use of approved insulating materials.

**H 62.07 Vents.** (1) **MAIN VENT.** All soil or waste stacks, 3 inches or more in diameter with fixtures on three or more floor levels, shall have the main vent connect full size to the main soil or waste pipe, below the lowest fixture branch.

(2) **CIRCUIT VENTS.** (a) *Water closets.* Circuit vents for water closets shall have a diameter of 2 inches for a battery of two closets, 3 inches for a battery of three to six closets and 4 inches for a battery of seven or eight closets.

(b) *Other fixtures.* The size of circuit vents shall be determined from the number of fixture units connected thereto. The size of the soil or waste branch shall be carried full diameter to the last fixture connection. A branch soil or waste pipe, to which two and not more than eight fixtures are connected may be vented by a circuit vent which shall be taken off ahead of the last fixture. See H 62.03 (1), (3), H 62.22 (10), (11), (12), (24).

(c) *Relief vents.* Where fixtures discharge above a soil or waste pipe served by a circuit vent each such pipe shall be provided with a relief vent in the form of a wet or dry vent, taken off ahead of the first fixture, with a diameter of not less than one-half the size of the soil or waste stack. No relief vent shall be less than one and one-half inches in diameter. See H 62.22 (10), (11), (12).

(3) **YOKE VENT.** All main soil and waste pipes, in buildings over five floors in height, shall be provided with yoke vents at each five floor intervals. The size of such vents shall be equal to the size of the main vent pipe.

*Note:* Compute floor levels from top floor down. See H 62.22 (12).

(4) **UNIT VENT.** Two sinks, basins, baths or any like fixtures located on the same floor discharging into a double "Y" or sanitary tee-cross may be vented by a single vent pipe. Where bath rooms, water closets or other fixtures are located on opposite sides of a wall or partition in the same building, or are directly adjacent to

each other, such fixtures may have a common soil or waste pipe and vent pipe stack. See H 62.06 (2), H 62.22 (13), (14).

(5) CROWN VENT. In no case shall a vent be taken off from the crown of a trap. See H 62.22 (19).

(6) DISTANCE FROM TRAP. Any vent pipe serving a fixture trap shall be connected as close to the trap as possible, but in no case shall the distance between the vent and trap be more than 24 times the inside diameter of the soil or waste pipe. This distance may be doubled where a drum trap is installed to serve a bath tub. The total grade of the soil or waste pipe shall not exceed the inside diameter of the pipe. See H 62.08 (1), (4) (c), H 62.22 (6), (7), (15), (19).

(7) BACK VENTS, NOT REQUIRED. (a) *Water closets and other fixtures.* Floor outlet water closets or other fixtures, not to exceed two, located on the same floor discharging into a vented double "Y" or sanitary tee-cross with no other fixtures discharging into the same pipe above them need not be individually back vented, providing the developed distance of the horizontal soil or waste pipe does not exceed 24 times the inside diameter of the pipe and the total grade does not exceed the inside diameter of the pipe. The vertical leg between the horizontal soil pipe and the water level of the water closet shall not exceed 3 feet. See H 62.06 (2), H 62.22 (13).

*Ann 3/1/57*  
(b) *Basement fixtures.* Water-closets, not to exceed two in number, basement floor drains, subsoil traps, elevator catch basins or similar receptacles need not be back vented when branched into horizontal drains 8 feet or more in the direction of the flow from the base of a soil or waste pipe stack 3 inches or larger in diameter. The developed distance of the horizontal waste branch shall not exceed 48 times the inside diameter of the pipe. See H 62.22 (6), (7).

(8) WET VENTS. Where wet vents are used, all fixtures must be located on the same floor level including the fixture creating the wet vent excepting for installations covered by H 62.22 (5), (16), and (35).

(9) REARRANGING OF VENT AND REVENTS. Where fixtures are afterwards installed on a soil or waste line above a point where the vent or revents enter the vent or vent stack, the vent and revent pipes of the fixtures already installed shall be rearranged to conform to the provisions of this code.

(10) VENT PIPE GRADES AND CONNECTIONS. All branch vent and back vent pipes shall be free from drops or sags, and shall be so graded and connected as to drain back to the soil or waste pipe by gravity. Whenever it becomes necessary to trap a horizontal vent pipe, it shall be drained back into a waste pipe by gravity. See H 62.22 (17).

(11) VENT CONNECTIONS. All vent pipes shall be run separately through the roof; be connected to other vent pipes or vent stacks a minimum of 12 inches below the roof; or be reconnected to the main vent pipe not less than 38 inches above the highest floor on which fixtures are installed. No fitting or fittings for future waste connections shall be placed in any soil or waste pipe above the point of revent connection. See H 62.22 (18).

(12) **ROOF TERMINALS.** (a) *Size.* Any vent pipe extending through a roof shall be at least 4 inches in diameter beginning at a point 6 inches or more below the roof boards unless a smaller diameter vent pipe is protected by a frost proof hood approved by the board. See H 62.16 (9).

(b) *Location.* The roof terminals of all vent pipes shall be extended at least 3 feet above any door, window, scuttle, air shaft or other opening used for ventilation when located at a distance less than 12 feet from such terminal. When it is necessary to extend the roof terminals of soil, waste or vent pipes more than one foot above the roof, they shall have an adequate frost-proof covering. Whenever a new building is erected higher than an adjacent existing building, the owner of the new building shall not locate windows within 12 feet of an existing vent stack on the lower building. See H 62.22 (18).

(13) **MATERIALS.** The materials used for vent pipes shall comply with H 62.06 (8). See H 62.14 (10).

(14) **PROTECTION FROM FROST.** All vent pipes shall be protected from frost as provided for in H 62.06 (9).

**H 62.08 Traps.** (1) **TRAPS REQUIRED.** Each fixture shall be separately trapped by a water seal trap, placed as near to the fixture as practical, except that laundry trays, wash tubs or double compartment sinks may waste into single traps. The use of "S" traps to the floor is prohibited. See H 62.22 (11), (19).

(2) **TRAP SIPHONAGE.** Every fixture trap seal shall be protected to prevent siphonage or back pressure by insuring air circulation with a vent or back vent. In no case shall a vent be connected at the crown of a trap.

(3) **TRAP CONSTRUCTION.** (a) *Design.* No trap which depends upon the action of movable parts for its seal shall be used. No trap shall be used which depends upon concealed interior partitions for its seal unless such interior partitions are made of indestructible material. No trap shall be used which in case of defect, would allow the passage of sewer air. No rubber or wicking packed slip joint connection shall be installed on the sewer side of a fixture trap. Unions on the sewer side of the trap shall be ground faced or equal, and shall not be concealed or enclosed. See H 62.22 (19).

(b) *Cleansing.* Every trap shall be self cleaning. Floating and sedimentary solids in the seal of the trap shall be removed by a normal discharge from the connected fixture. Uniform diameter traps shall be considered self-cleaning.

(c) *Material.* The material for traps shall be either vitreous china, clay, lead, brass, cast iron or malleable iron. Cast iron traps shall be coated on the inside and outside with an approved rustproof coating.

(d) *Depth of seal.* The water seal of all fixture traps shall be at least 2 inches. A deep seal trap shall have a water seal of 4 inches.

(e) *Approval.* Every trap shall have the maker's name, or registered trade mark, cast or stamped upon the exterior surface thereof.



Traps varying from standard design shall have the approval of the board before being used in any installation. See H 62.15 (10) (d).

(4) TRAP INSTALLATIONS. (a) *Setting of traps.* All traps shall be so located as to be accessible, rigidly supported and set true with respect to their water level and so located as to protect their seals. See H 62.07(6).

(b) *Traps where prohibited.* No fixture shall be double trapped and there shall be no traps at the base of soil or waste stacks.

(c) *Bath and shower traps.* Drum traps not less than 4 inches in diameter and having a seal of not less than 2 inches, should be used under all bath tubs and shower baths wherever practicable. See H 62.07 (6).

(d) *Deep seal traps.* Deep seal resealing traps of the centrifugal, self-scouring type may be used when a common trap is not adequate protection against sewer air, or when it is impractical to provide a proper back vent. So far as practical a free circulation of air shall be provided. Traps of this type shall not be permitted in new construction.

(e) *Traps for rain water leaders.* One trap may serve for one or more rain water leaders. When rain water leaders are carried up to the roof of a building they need not be provided with traps, unless such conductors terminate within 12 feet of any door, window, ventilating hood or air intake. All conductor traps shall be provided with cleanout connections on the outlet side. Such cleanout shall be extended 2 inches or more above floor or grade level wherever practical. Traps may not be required when connected to a storm sewer.

(5) MAIN HOUSE TRAP. (a) *Location.* The main house drain may be provided with a horizontal trap set level and placed immediately inside the foundation wall where the sewer enters the building. This trap shall be provided with a 4-inch or larger screw thread cover cleanout. Main house traps may be removed in existing buildings where the roof terminals of conductors, soil and vent stacks are favorably located, when plumbing is free from defects, fixture traps properly protected from siphonage, and the installation made in a durable and sanitary manner, as provided for in this code. When main house traps are used they shall be provided with a fresh air inlet. See H 62.22 (21).

(b) *Fresh air inlets.* A fresh air inlet shall be connected on the house side at least 2 feet from the water seal of the main trap. The inlet when exposed shall be covered with a substantial fresh air cap or return bend. When located under a porch a free circulation of air shall be provided. No fresh air inlet shall be so placed that a cold air intake for a furnace or heater may draw air from the same; nor shall it be open at a point less than 4 feet from any door, window or other air intake.

H 62.09 Cleanouts. (1) PIPE CLEANOUTS. (a) *Size.* Cleanouts shall be the same size as the pipe up to 4 inches in diameter and not less than 4 inches for larger pipe. See H 62.22 (16).

(b) *House drain.* A 4-inch cleanout with brass screw cover, shall be provided at a point where the house drain leaves the building. This cleanout shall be extended from the house drain with a cast

iron soil pipe to the surface of the finished floor or grade and wherever practical shall be not less than 2 inches above the finished floor or grade. Where the house drain or a branch to a soil or waste stack exceeds 25 feet in length an additional cleanout shall be provided for such soil or waste stack located at a point 28 to 30 inches above the floor. See H 62.09 (3), H 62.22 (21), (22).

(c) *Toilet and washrooms.* Cleanouts shall be provided in connection with batteries of water closets, urinals, wash basins, sinks and showers, at such points that all parts of the branch waste and soil pipes may be reached conveniently for cleaning or removal of stoppages.

(d) *Sink wastes.* Waste pipes from sinks or other similar fixtures, discharging greasy wastes, shall have sufficient accessible cleanouts spread over their entire length.

(2) **TRAP CLEANOUTS.** All fixture traps shall be so designed and installed that stoppages may be removed. All small fixture traps shall be provided with cleanouts of the screw plug or removable dip type. Where the "U" or dip is removable the coupling nut on the discharge side shall be within the dip of the trap. Traps for urinals rising from the floor and traps serving shower baths and floor drains, when inaccessible, shall be so installed as to make the removable inlet serve as a cleanout. See H 62.22 (31).

(3) **CONSTRUCTION.** The bodies of cleanout ferrules shall be made of cast iron or brass and shall extend not less than one-fourth inch above the hub receiving it. When solid brass screw caps for cleanouts are used, they shall be at least three-sixteenths inch in thickness and provided with standard pipe threads and one inch square or hexagonal solid head at least three-fourths inch high or adequate inverted countersunk sockets. The ferrules when constructed of brass shall be at least three-sixteenths inch in thickness; and when constructed of iron the same weight per foot as for cast iron soil pipe. The screw thread shall have at least five threads of iron pipe size. The tops of cleanout plugs shall be tool faced to a flawless smooth surface and so as to insure a tight joint. A cleanout with an approved ground joint, poured lead or equal metal seat between a brass or cast iron cover and the ferrule may be used. A brass plug of standard pipe size shall be used where cast iron threaded drainage fittings serve as cleanout openings.

**H 62.10 Floor drains.** (1) **BASEMENT FLOOR DRAINS** shall connect into a cast iron deep seal trap not less than 3 inches in diameter, so constructed and installed that it can be readily cleaned. The drain inlet shall be so located that it is at all times in full view. When subject to back flow such drains shall be equipped with an adequate back water valve. When possible, ice box drains, bubbler and similar wastes may be connected with a floor drain. See H 62.22 (23).

(2) **FLOOR WASTES FROM LAUNDRIES AND SIMILAR ESTABLISHMENTS.** Waste pipes in dye houses, breweries, bottling works, creameries, laundries and similar establishments may discharge directly onto a nonabsorbent floor provided with an adequate number of floor drains. Where necessary to prevent discharge of coarse materials to a sewer system, suitable screen or catch basins shall be provided. See H 62.22 (24), (25).

(3) **ICE-HOUSE AND STORAGE DRAINS.** The floor drains in ice-house and refrigerator rooms, markets, slaughterhouses, storage rooms, or any rooms where ice is stored or used shall be of adequate size, properly trapped, and when necessary discharge into a catch basin. The inlet to such floor drains shall be in plain view at all times.

Ann 3/1/57  
 (4) **SUBSOIL, TRAP RECEIVER.** The discharge of drain tile from footings of buildings shall be collected in a subsoil receiver or trap when direct discharge to the ground surface is impractical. A trap receiver shall have a cleanout brought to the surface of the floor. A combination floor drain and subsoil drainage receiver may be used. All subsoil drainage outlets where connected to a house drain or sewer shall be equipped with an effective back water valve. Foundation drains should not be connected to sanitary sewers. See H 62.22 (26).

Ann 3/1/57  
 (5) **AREA AND COURT DRAINS.** When permitted to connect to the sanitary or house drainage system the various drains from small yards, areas and courts may be connected together and their contents discharged into a yard catch basin, an adequate basement floor drain or a deep seal trap, so located that it is readily accessible for cleaning and is protected from frost. The surface opening of the drain to catch basin must be provided with an adequate strainer, and where necessary with a backflow valve.

**H 62.11 Catch basin, sumps, ejectors.** (1) **CONSTRUCTION OF CATCH BASIN.** Catch basins shall be constructed in a water tight and substantial manner of brick, cement, concrete, cast iron, bitumastic enamel coated 14 gauge steel or wrought iron or vitrified clay pipe. The outlet shall be provided with a cast iron sanitary tee not less than 4 inches in diameter and be submerged not less than 6 inches below the flow or water line. A 4-inch cleanout shall be provided on the tee. The basin shall have a stone, cement or cast iron cover. No catch basin shall be located within 25 feet of any well. Catch basins shall be constructed according to the use for which they are intended. When connected to a sanitary sewer they shall be located and designed so as to exclude storm water.

(2) **GREASE SEPARATORS.** (a) *When required.* Grease catch basins or interceptors of a capacity based upon the temperature and amount of water tributary shall be installed wherever kitchen or other greasy wastes from hotels, restaurants, club houses, boarding houses, public institutions, hospitals or other similar places are discharged into a house drain or sewer. Garbage disposal units should not be tributary to catch basins or interceptors.

(b) *Location.* Whenever possible, grease catch basins shall be installed outside the wall of the building, as near as possible to the fixtures from which it receives the discharge. Such basin shall be protected against freezing. See H 62.22 (27), (28).

(c) *Capacity.* The liquid content capacity in gallons shall be not less than the flow tributary during any one hour, based upon an allowance of from 2 to 4 gallons of waste water per meal served.

(d) *Construction.* Grease catch basins shall be constructed in the same general manner as provided for catch basins. The inlet and outlet shall be placed as far apart as possible and the depth below

outlet flow line shall be not less than 2 feet. The inlet shall not be submerged, and not be more than 12 inches above the flow line of the outlet invert. Grease catch basins when located inside of buildings, shall be provided with a removable air-tight stone, cement or cast iron cover. When bolted covers are provided, the bolts shall be of a non-corrosive metal. See H 62.22 (27).

(e) *Commercial interceptors.* Grease basins of this type shall have sufficient capacity, and be properly installed and maintained so they will serve the purpose for which intended. Iron grease traps shall be made of not less than 12 gauge copper bearing steel, pure iron or cast iron. Manufacturers ratings will be acceptable when approved by the board.

(f) *Maintenance.* Cleaning and removal of grease, sediment, or foreign matter which may prevent the satisfactory operation of the interceptor or basin, shall be performed at intervals of such frequency as to prevent the entrance of grease or foreign matter into the drainage system.

(3) **YARD CATCH BASINS.** A yard catch basin shall be constructed in the same general manner as provided for catch basins; they shall be at least 24 inches in diameter, and where possible the outlet shall be at least 4 feet below the surface of the ground or as nearly so as grade of house drain will permit. The outlet invert shall be submerged not less than 6 inches below the water line. The flow or water line shall not be less than 2 feet above the bottom. A yard catch basin may be installed to receive surface drainage or discharge from a pump, hydrant or other outside areas. It may connect only with a storm or combination sewer. See H 62.22 (29).

(4) **STABLE CATCH BASINS.** When liquid wastes from barns, stables, manure pits, and yards are permitted to enter the public sewer system, they shall be intercepted by a catch basin. See H 62.22 (29).

(5) **GARAGE REFUSE SEPARATORS.** (a) *Where required.* All liquid wastes, sand and grit from public garages, service pits and paved areas adjoining service pits, which come in contact with kerosene, gasoline, benzine, naphtha or other inflammable oils or compounds, shall be intercepted before entering the house drain or sewer, by an approved catch basin properly trapped. Gasoline and oil interceptors approved by the board may be installed.

(b) *Capacity.* Garage catch basins or sand traps shall be of a size sufficient to retain the sand and dirt washings reaching the basin during any 10-hour period. The basin shall have a minimum width of not less than 24 inches, and a depth below the water level of not less than 24 inches. See H 62.22 (30).

(c) *Construction.* Construction of garage catch basins or sand traps, shall conform to general requirements for catch basins. The outlet invert shall enter the walls of the basin so that the space between the water line in the basin and the floor level shall not exceed 10 inches. The outlet shall consist of a cast iron sanitary tee laid horizontally with a depth of invert of not less than 6 inches below the water line. The invert shall be provided with a 4-inch cleanout. An open bar strainer not less than 16 inches in diameter shall be provided. Where it is impractical to keep the outlet within 10 inches of the floor level a greater distance will be permitted. In all such

installations a 4-inch local vent pipe shall be provided. Such local vent pipe shall enter the basin above the water line. Same shall terminate through roof or with a return bend outside of the building not less than one foot above the grade level. Where a vertical local vent pipe is installed, properly intercepted floor drains will be permitted to be connected thereto provided the total distance does not exceed 50 feet. Conductors or rain water leaders will not be permitted to act as local vent pipes.

(d) *Cleaning.* Garage catch basins or interceptors shall have the accumulated oil, gasoline or other inflammable fluids, sand, silt or other solids removed at regular intervals.

(6) **SUMPS.** (a) *Location.* All house drains discharging below the flow line of the main sewer, shall discharge into an air and water tight sump or receiving tank, so located as to receive the drainage by gravity, from which sump or receiving tanks the drainage shall be lifted and discharged into the house drain or sewer by pumps, ejectors or any equally efficient method. All sumps installed for the purpose of receiving clear water, basement or foundation drainage water, sink or laundry tray waste shall be located at least 15 feet from any water well. All other sumps shall be located at least 25 feet from any water well.

(b) *Capacity.* The capacity of a sump or receiving tank shall be determined by computing all possible drainage tributary to the sump, including foundation drainage, boiler blowoffs, basement areas to be drained, depth of basement below house drain outlet, locations near a river or lake, soil conditions and types and number of fixtures.

(c) *Air inlet.* Any sump receiving domestic wastes shall have a fresh air inlet. The size of the air inlet pipe required will depend upon the size of the sump, varying from 2 inches to 6 inches. The air inlet pipe may be connected to a plumbing system vent pipe or extended separately to conform with the provisions of this code.

(d) *Vent.* The drain leading to a sump or receiving tank shall, when a closet or closets are installed, be provided with a vent stack not less than 3 inches in diameter. Where fixtures other than closets are installed the vent/pipe size shall be determined from the tables in H 62.03 (1) and (3).

(7) **EJECTORS.** (a) *Where required.* In all buildings in which the whole or a part of the plumbing and drainage system lies below the flow line of the main sewer, the sewage, house wastes, foundation drainage, and seepage, shall be lifted by mechanical means, and discharged into the main sewer, house drain or house sewer, or properly trapped fixture.

(b) *Size.* The size and design of an ejector pump shall be determined by the capacity of the sump to be served, the discharge head and discharge frequency. Manufacturers ratings may be used.

(c) *Discharge connections.* The discharge pipe from the ejector to the building drain shall be connected through a branch Y fitting. The drain into which the ejector discharges shall be of sufficient size to receive the combined flow from the building and the ejector. Flanged connections and long radius fittings should be used.

(d) *Check valves.* Horizontal check valves shall be installed in each discharge line. Such valves may be omitted where the discharge

pipe forms a loop 2 feet or more above the building drain and is provided with an adequate vent pipe to break the siphon action. When the drain is subject to backflow a check valve shall be used.

(e) *Fixture connections. Venting.* Fixtures located on a house drain near the point where such house drain receives the discharge from an ejector shall be effectively protected against siphonage, and an additional air relief or vent pipe shall be provided where necessary. No fixtures shall be connected to the discharge pipe from an ejector, between the ejector and the point where it enters the house drain or sewer.

(f) *Maintenance.* All such ejectors and like appliances shall receive care as needed to keep them in a satisfactory operating condition.

**H 62.12 Fixtures. (1) CONSTRUCTION AND MATERIALS.** All plumbing fixtures shall be of such design, materials and construction as to insure durability, proper service, sanitation, and so as not to entail undue efforts in keeping them clean, and in proper operating condition. See H 62.17.

(2) **INSTALLATION.** All plumbing fixtures shall be installed in a manner to afford easy access for cleaning. Enclosures under or around fixtures shall be provided with a circulation of air. Where practicable all pipes from fixtures shall be run to the wall. Back-grounds, except under special conditions shall be provided for the securing of closets, tanks, basins, sinks, brackets and all other wall fixtures or hangings.

(3) **FIXTURE OUTLETS.** Outlet passageway shall be free from impairments and of sufficient size to insure proper discharge of the fixture contents, under normal conditions. Outlet connections shall be such that a permanent air and water-tight joint can be readily made between the fixture and drainage system.

(4) **BATHTUBS, BASINS, SINKS, LAUNDRY TRAYS.** All such fixtures shall be made of earthenware, vitreous chinaware, enameled iron ware or other impervious material. Sinks and laundry trays may be made of other materials where conditions make it necessary. Wooden trays or sinks with or without metallic lining shall be allowed only in public laundries and dye houses where such fixtures are in daily use. Sinks or trays made in an approved manner of heavy black or galvanized iron may be used for special purposes.

(5) **SHOWER BATHS. SAFING.** All shower baths except those directly over unexcavated portions of a building, or where a shower receptacle is used, shall be safed with sheet lead or other noncorrosive material beneath the entire shower stall and upward along the sides of the stall for a distance of at least 6 inches. The safing shall be properly drained and coated with asphaltum.

(6) **DRINKING FOUNTAINS.** All drinking fountains shall be made of earthenware, vitreous chinaware, enameled iron ware or other impervious material. The bowl shall be so designed and proportioned as to be free from corners that it may be readily cleaned, and so as to prevent unnecessary splashing at the point where the jet falls into the bowl. The nozzle shall be of non-oxidizing impervious material and shall have no fouling space or enclosures making cleaning

difficult or inducing insanitary conditions. The jet shall be inclined and the orifice shall be higher than the rim of the waste water receiving bowl. Drinking fountains shall not be installed in toilet rooms. The water supply shall be provided with an adjustable valve fitted with a loose key or an automatic self closing valve permitting regulation of the rate of flow of water. The water supply issuing from the nozzle shall be of sufficient volume and height so that persons using the fountain need not come in direct contact with the nozzle or orifice. To accomplish this it is recommended that the fountain supply be equipped with an efficient automatic pressure and volume regulating valve.

(7) FLOOR DRAINS AND SHOWER DRAINS shall be considered a fixture and be provided with a strainer.

(8) CLOSETS. (a) *Water-closets.* All water-closets shall be made of vitreous chinaware. The bowl and trap must be made of the combined pattern in one piece. They shall hold a sufficient quantity of water and be of such shape and form that no fecal matter will collect on the surface of the bowl. All water-closet bowls shall be equipped with adequate flushing rims, so as to flush and scour the bowl properly when discharged.

(b) *Frostproof closets.* Frostproof closets will be permitted in buildings when extreme conditions necessitate their use. When installed, the bowl must be of vitreous chinaware or cast iron enamel of the flush rim pattern provided with an adequate tank automatically drained. The soil pipe between the hopper and the cast iron trap shall be of 4-inch cast iron, free from offsets and only of sufficient length to protect the trap against frost; but in no case shall the soil pipe between the trap and hopper bowl be more than 6 feet in length.

*Note:* The water flushing device must be such as to meet the requirements prescribed in H 62.19. The installation and use of the frostproof type of fixture is to be discouraged as much as possible. Under the most favorable conditions little can be said for this closet from a practical and sanitary standpoint.

(c) *Range closets.* Range closets may be installed for temporary or infrequent use only, and in such situations that the range closet will not be in use more than 30 days in any year. Range closets shall be made of cast iron with all surfaces either porcelain enameled or coated with a non-corrosive paint, or vitreous earthenware thoroughly glazed. Range closets shall be provided with an automatic dumping tank or may be of the siphon ejection type. The tank shall supply for each single seat not less than two gallons of water at each discharge. The entire volume of water shall be delivered at once at one end, and discharged at the other end of the trough. The discharge from such ranges shall be properly trapped and vented before final disposal to septic tank or public sewer.

(9) URINALS. (a) *Type.* Urinals shall be made of material impervious to moisture and which will not corrode under the action of urine, and be of such design, materials, and construction that they may be properly flushed and kept in a sanitary condition. If cast iron is used in the construction of urinals it must be enameled on the inside and coated with durable paint or be enameled on the outside. No sheet iron urinals will be permitted except in outbuildings such as private or similar enclosures situated where a public or

private sewage system is not available. Only individual urinals shall be used in public buildings and places of employment. Such individual urinals shall be of porcelain or vitreous china, set into the floor and the floor graded toward the urinal and shall be equipped with an effective automatic tank or a satisfactory foot-operating flushing device. See H 62.22 (31), H 63.03.

(b) *Flushing.* All stall urinals connected to a sewerage system shall be provided with an effective automatic tank or a satisfactory foot operating flushing device. All automatic flushing devices shall be so adjusted as to cause thorough flushing of the urinal at regular intervals. A battery of not more than four stall urinals may be flushed with one automatic tank, providing the flush pipe is so sized and graded as to insure sufficient pressure, volume, and equal distribution of the tank contents. Existing urinals of the trough or gutter pattern shall be flushed either by automatic flushing tanks or by an adequate direct water supply through a brass distributing pipe with perforations at 2-inch intervals and extended the full length of the gutter. The backs of gutter stalls to a height of 3½ feet shall be kept constantly moist with a supply of water while the fixture is in use.

**H 62.13 Rain water connections.** (1) **RAIN WATER DISPOSAL.** Where no storm sewer is accessible, surface inlets and rain water conductors should be drained separately to the curb line where practicable by drain pipes not less than 4 inches in diameter, and discharge into the public gutter, unless permitted to drain elsewhere. See H 62.04 (10) (b).

(2) **INSTALLATION DETAILS.** (a) *Inside leaders.* All roof leaders placed within the walls of any building, in an interior court, ventilating or pipe shaft, shall be installed as specified for soil, waste and vent pipes when connected to a combination sewer or drain. Rain water leaders shall not be used as soil, waste or vent pipes; nor shall any soil, waste or vent pipes be used as rain water leaders. Outside catch basins, garage drains, area drains and subsoil drains installed in compliance with the provisions of this code may be connected to conductors at a point more than 4 feet below grade level.

(b) *Rain water connected to storm sewers.* Rain water leaders within a building connecting to storm sewers shall be treated in the same manner as those entering a combination system, except that pipe used in construction may be cast iron, galvanized, asphaltum coated or black iron pipe.

(c) *Connection to drains.* When rain water leaders are connected to house drains within the building, the horizontal part extending 2 feet inside the basement wall and the vertical portion outside the building wall shall terminate with the hub above grade line, and shall be made of cast iron of same weight and durability as provided for house drains. See H 62.22 (32).

(d) *Roof terminal connections.* Connections between gutters, troughs, roof areas, and rain water leaders inside the building shall be made of durable materials. The term "durable" material as used in this section shall mean a brass ferrule, a brass soldering nipple, light lead pipe, 12 oz. copper, No. 18 gauge brass or cast iron receivers properly connected.



(e) *Defective rain water leaders.* When an existing rain water leader within the walls of any building becomes defective, such leader shall be replaced by one which conforms to the requirements of this code.

(3) **CISTERN OVERFLOW.** Overflow pipe from cisterns shall not connect directly with any house sewer, but shall discharge into an open fixture, catch basin or floor drain. Overflow pipes from cisterns, however, shall not discharge into sanitary sewers.

**H 62.14 Special requirements.** (1) **TOILET ROOM VENTILATION.** All toilet rooms and bathrooms shall have at least one outside window that may be opened or be provided with local vent pipes or air shafts extending to the outside air. Local vents or air shafts for toilet rooms shall not be connected with the plumbing system, and must be so installed as to provide adequate ventilation. See H 62.15 (14).

(2) **BAR WASTES.** Bar, soda fountain, and similar wastes may be installed in accordance with one of the methods shown in H 62.22 (33). The waste pipe outlet and trap may be located at either side of the fountain or serving counter or at any convenient point at the side thereof. The horizontal local waste pipe shall not exceed 30 feet. Accessible cleanouts shall be provided.

*Note:* Waste piping may be made of copper or brass with approved fittings and joints; or cast iron or galvanized iron with approved fittings, joints and connections. Unions of the ground joint type or equivalent should be used at such points that the entire piping may be readily taken down for purposes of cleaning.

(3) **REFRIGERATOR WASTES.** The waste pipe from a refrigerator, ice box or trap, or any receptacle in which provisions are stored shall not connect directly with any drain, soil or waste pipes. Such waste pipes shall be so arranged that they may be flushed properly. See H 62.22 (34).

(4) **HYDRAULIC MACHINERY.** Wastes from hydraulic motors, hydraulic elevators, or other machinery discharging large quantities of water, shall be detained in a catch basin or receiving tank of sufficient size, and so connected as to prevent the discharge of the wastes under pressure. See H 62.05 (4), H 62.07 (7) (b).

(5) **DRINKING FOUNTAIN DRAIN.** Waste pipes from drinking fountains may discharge into a trapped funnel or floor drain. Such waste pipes however, must be trapped to preclude their use as a local vent pipe. When drinking fountains are located on four or more floor levels and connect to the same local waste stack, such stack shall be extended separately through the roof. When drinking fountains are connected directly to soil, waste or drain pipes, they shall be trapped and vented properly. For methods of installation see H 62.22 (35).

(6) **DENTAL CUSPIDORS.** Dental cuspidors when connected to a waste pipe must be effectively trapped and vented, as shown in H 62.22 (36). The length of the horizontal waste pipe between the vent pipe and trap must not exceed 15 feet. The total fall of the horizontal waste pipe between trap and vent shall not exceed the inside diameter of said waste pipe.

(7) **CLEAR WATER DRAINS.** The discharge of clear water from beer pumps, water motors, overflow pipes from water supply tanks, expansion tanks, and drip pans shall be provided for in the same

manner as for refrigerator wastes. Overflows of this type discharging large amounts of water or which have a constant flow may not under certain conditions discharge directly or indirectly into a private sewage treatment system.

(8) **ACID WASTES.** (a) *Neutralizing basins.* Where it is necessary to dilute or neutralize acid wastes to properly protect the piping of a drainage system, all acid wastes from sinks or other receptacles shall discharge into a catch basin or neutralizing basin of a capacity sufficient to properly dilute or neutralize such wastes.

(b) *Piping.* The waste pipes and traps for acid tanks, sinks and other receptacles receiving the discharge of acids in chemical laboratories, electrotyping, lithographing and other similar establishments must be made of extra heavy acid resisting or acid proof type, extra heavy lead pipe, or lead-lined iron pipe of adequate durability. The waste pipes when serving as a local conveyor between acid tank, dilution tank or other receiving basin may be of asbestos cement pipe and fittings or of vitrified clay incased in concrete of substantial construction or its equal and provided with a vent pipe to the open air where necessary. See H 62.15 (14).

(9) **BOILER BLOWOFF BASIN.** All exhaust, blowoff, sediment or drip pipe connections from a high pressure steam boiler, shall not be connected to any house sewer or drain, without first being cooled to a temperature below 140° Fahrenheit in a suitable tank, catch basin, or other cooling device. The capacity of the catch basin or other cooling devices shall depend upon the steam pressure carried, the size of the boiler, and method of operation. The capacity of such basin shall be sufficient to hold at least one gauge of the boiler. All cooling devices when receiving the blowoff from such boilers shall be provided with a relief pipe, extended independently to the outer air. The size of the relief pipe shall be equal to the threaded opening provided in the cover of the basin.

(10) **PIPE BENDING PROHIBITED.** Bending of brass, galvanized steel or galvanized wrought iron pipe is prohibited. See H 63.04.

**H 62.15 Materials.** (1) **QUALITY.** All material used in any drainage or plumbing system, or part thereof, shall be free from defects that impair service.

(2) **LABELING.** Each length of pipe, fitting, trap, fixture, and device used in a plumbing or drainage system, shall be stamped or indelibly marked with the weight, or quality thereof, and the maker's mark or name.

(3) **VITRIFIED CLAY PIPE** shall conform to the A.S.T.M. "Standard Specifications for Clay Sewer Pipe," serial designation C-13, latest revision.

(4) **CONCRETE PIPE** shall conform to A.S.T.M. "Standard Specifications for Concrete Sewer Pipe," serial designation C-14, latest revision. See H 63.01, H 63.02.

(5) **CAST IRON PIPE AND FITTINGS.** (a) *Specifications.* Cast iron pipe and fittings shall conform to the A.S.T.M. "Standard Specifications for Cast Iron Soil Pipe and Fittings," serial designation A-74, and federal specification WW-P-401, latest revisions.

(b) *Quality.* Soil pipe and fittings shall be made of close grained gray iron and shall be ductile and smooth on the inside, free from flaws, sand holes or other defects and of a uniform thickness.

(c) *Weights.* The weight of cast iron pipe and fittings shall conform to that shown in the accompanying table. Use of standard weight pipe shall be limited to buildings two stories or less in height, and service weight pipe to buildings five stories or less in height. Extra heavy weight pipe shall be used in buildings six stories or more in height. Wall thickness of fittings and the hubs shall correspond with that of the pipe of the same size and kind.

| Diameter | Standard pounds per foot | Service pounds per foot | Extra Heavy pounds per foot |
|----------|--------------------------|-------------------------|-----------------------------|
| 2-inch   | 3½                       | 4                       | 5                           |
| 3-inch   | 4½                       | 6                       | 9                           |
| 4-inch   | 6½                       | 8                       | 12                          |
| 5-inch   | 8-2/5                    | 10-4/5                  | 15                          |
| 6-inch   | 10-1/5                   | 13                      | 19                          |
| 8-inch   |                          | 20                      | 30                          |

*Note:* Most manufacturers have discontinued production of "standard" weight soil pipe. Use of "service" weight pipe is recommended because of its greater strength.

(d) *Screw thread pipe.* All cast iron screw thread pipe used for soil, waste or vent pipe shall be smooth on the inside and outside, free from flaws, sand holes, or other defects and of uniform wall thickness. The outside shall be sufficiently circular and the iron shall be such as to permit cutting of a satisfactory standard sharp thread conforming to the specifications for wrought iron or steel pipe.

(e) *Coating.* All pipe and fittings shall be coated with asphaltum or coal tar pitch.

(f) *Bends.* When direction of flow changes from horizontal to vertical the radius of bends shall be as follows:

|                |    |     |    |     |    |
|----------------|----|-----|----|-----|----|
| Size of pipe   | 2" | 3"  | 4" | 5"  | 6" |
| Minimum radius | 3" | 3½" | 4" | 4½" | 5" |

When direction of flow changes from vertical to horizontal or when it is at right angles and changes in the same horizontal plane the radius of bends shall be as follows:

|                |    |     |    |     |    |
|----------------|----|-----|----|-----|----|
| Size of pipe   | 2" | 3"  | 4" | 5"  | 6" |
| Minimum radius | 5" | 5½" | 6" | 6½" | 7" |

*Note:* For method of determining radius see H 62.22 (37). A combination Y and 1/8 bend fitting or a Y and 1/8 bend are recommended. When a pipe of smaller diameter enters a pipe of greater diameter, a fitting with a minimum radius as shown may be used. When sanitary tees are used in change of direction they shall be so arranged that the flow from other fixtures will serve as a wash.

(6) **WROUGHT IRON PIPE (GENUINE).** All wrought iron pipe shall be galvanized and shall conform to the A.S.T.M. "Standard Specifications for Welded Wrought Iron Pipe," serial designation A-72, latest revision.

(7) **MILD STEEL PIPE.** All mild steel, welded or seamless, shall be galvanized, and shall conform to the A.S.T.M. "Standard Specifications for Welded and Seamless Steel Pipe," serial designation A-53, latest revision.

(8) **SCREW THREAD FITTINGS.** Threaded fittings for vents, back vents, soil and waste pipes shall be of cast iron, galvanized malleable iron or brass. Waste fittings shall be of recessed, drainage pattern, and shall be galvanized or asphaltum coated. Drainage fittings shall have a minimum length from face to center as follows:

|                        |    |    |    |    |    |    |    |    |
|------------------------|----|----|----|----|----|----|----|----|
| Pipe size, inches----- | 1¼ | 1½ | 2  | 2½ | 3  | 4  | 5  | 6  |
| Length, inches-----    | 2¼ | 2½ | 3¼ | 3¾ | 4¼ | 5¼ | 6¼ | 7¼ |

*Note:* Long turn Y branches or Y and 1/8 bend are recommended. See H 62.14 (10) and H 62.22 (38).

(9) **LEAD MATERIALS.** (a) *Waste and vents.* Lead waste and vent pipes shall be the best quality of drawn lead pipe, having a minimum weight per foot as follows:

|                              |    |    |    |   |   |
|------------------------------|----|----|----|---|---|
| Inside diameter, inches----- | 1¼ | 1½ | 2  | 3 | 4 |
| Weight per foot, pounds----- | 2½ | 3½ | 4¼ | 6 | 8 |

(b) *Traps.* All lead traps and bends shall have a minimum wall thickness of one-eighth inch.

(c) *Water supply piping.* Lead water supply piping should have minimum weights shown in the following table:

| Inside diameter, inches | Weight lbs. per foot | Wall thickness inches | Classification |      |
|-------------------------|----------------------|-----------------------|----------------|------|
|                         |                      |                       | East           | West |
| ¾-----                  | 2                    | -----                 | AA             | XS   |
| 1-----                  | 2                    | -----                 | AA             | XS   |
| 1¼-----                 | 3                    | -----                 | AA             | XS   |
| 1½-----                 | 3½                   | .231                  | AA             | XS   |
| 1-----                  | 4¾                   | .246                  | AA             | XS   |
| 1¼-----                 | 7¾                   | .320                  | AAA            | XXS  |
| 1½-----                 | 11¼                  | .386                  | AAA            | XXS  |
| 2-----                  | 19½                  | .504                  | AAA            | XXS  |

(d) *Sheet lead.* Sheet lead shall weigh not less than 4 pounds per square foot.

(10) **BRASS PIPE AND FITTINGS.** (a) *Specifications.* All brass pipe used for soil, waste, vent and water pipes, except fixture traps and overflows, shall be of commercial standard pipe size and conform to A.S.T.M. "Standard Specifications for Brass Pipe," serial number B-43, latest revision.

(b) *Fittings for soil and waste pipes.* Brass screw thread fittings used for soil and waste pipes, shall be of the recessed, drainage fitting pattern.

(c) *Fittings for water pipe.* Fittings and couplings for brass water pipe shall be of unfinished red brass, with flat band, guaranteed for 175 pounds water-working pressure and shall conform to A.S.A. "American Standard Brass or Bronze Screwed Fittings," serial number B-16.15, latest revision. In erecting brass pipe, friction wrenches and friction vises shall be used exclusively except on pipe larger than 3 inches in diameter.

(d) *Brass tubing.* All brass tubing used for fixtures, traps and overflows between wall or floor and fixtures shall be made of seamless brass tube with a thickness of at least 0.0453 inch (No. 17 Brown & Sharp Gauge) and shall conform to A.S.T.M. "Standard Specifications for Seamless Brass Tubes," serial number B-135, latest revision.

(e) *Traps and overflows.* All brass fittings used for fixtures, traps and overflows shall be of a good quality of brass, free from sand holes, flaws or other defects, and of a uniform thickness equal to twice the thickness of the brass tubing. The thickness of the threaded ends shall be equal to the thickness of the fitting at the root of the thread.

(f) *Soldering nipples* shall be of heavy cast brass, or of brass pipe of weight, thickness and size conforming to standard pipe sizes. (SPS). When cast they shall be of full bore and of not less than the weights given in the following table:

| Inside diameter | Weight       |
|-----------------|--------------|
| 1¼ inch.....    | 0 lb. 6 oz.  |
| 1½ inch.....    | 0 lb. 8 oz.  |
| 2 inch.....     | 0 lb. 14 oz. |
| 2½ inch.....    | 1 lb. 6 oz.  |
| 3 inch.....     | 2 lb. 6 oz.  |
| 4 inch.....     | 3 lb. 8 oz.  |

(g) *Weight of brass ferrules.* Brass ferrules shall be of a good quality of brass, composed of a mixture that will fuse readily with plumbers' solder, free from sand holes, flaws or other defects uniform in thickness, and at least four and one-half inches long, of a size and weight as shown in the following table:

| Inside diameter, inches | Weight       |
|-------------------------|--------------|
| 1½.....                 | 1 lb. 1 oz.  |
| 2.....                  | 1 lb. 4 oz.  |
| 3.....                  | 1 lb. 14 oz. |
| 4.....                  | 2 lb. 8 oz.  |
| 5.....                  | 3 lb. 0 oz.  |
| 6.....                  | 3 lb. 8 oz.  |

(11) COPPER TUBE AND FITTINGS. (a) *Copper tube* used for water, soil, waste and vent piping shall conform to A.S.T.M. "Standard Specifications for Seamless Copper Water Tube," serial number B-88, latest revision. Copper water tube used for underground water lines shall be type "K," either soft or hard temper. Copper tube used for interior water lines shall have a wall thickness equal to or better than type "L" and shall be hard temper, except that concealed vertical tube may be of soft temper for repair and replacement lines only. Copper tube used for soil, waste and vent piping shall have a wall thickness equal to or better than type "M" and shall be of hard temper.

(b) *Fittings* used with copper water tube shall be of the sleeve type, of such size that the solder will completely fill the joints by capillary action. Cast red brass fittings shall conform to A.S.A. "American Standard Cast-Brass-Solder-Joint Fittings," serial number B-16.18, latest revision. Wrought copper fittings may be used for water piping only and shall have a wall thickness at least equal to that of the tube with which it is to be used. All waste fittings shall be cast red brass recessed drainage fittings and shall be soldered. Sleeve branches (saddle tees) will not be allowed. Fittings on water pipe may be soldered, flared or flanged provided that all above-

ground tube which will be concealed shall be soldered. The solder used shall be 50-50 lead-tin (new metals) or tin-antimony containing 90 to 96 per cent tin and 4 to 10 per cent antimony.

(12) SHEET COPPER OR BRASS. All sheet copper or brass shall be of sufficient weight to serve the purpose for which it is used. Sheet used for local and interior ventilating pipe shall have a thickness of at least 0.0159 inch (No. 26, B. & S. gauge).

(13) GALVANIZED SHEET IRON. Galvanized sheet iron for local room vents shall be not lighter than the following B. & S. gauge:

No. 26 for 2 to 12 inch pipe.

No. 24 for 13 to 20 inch pipe.

No. 22 for 21 to 26 inch pipe.

(14) ASBESTOS CEMENT PIPE AND FITTINGS. Asbestos cement pipe and fittings and other equal piping materials with approved fittings and methods of jointing may be used for local vent pipes. See H 62.14 (8)(b), H 63.02.

*Note:* The addresses of the organizations preparing standards referred to in this section are as follows:

A.S.A. (American Standards Association), 70 East 45th St., New York 17, N. Y.; A.S.T.M. (American Society for Testing Materials), 1916 Race St., Philadelphia 3, Pa.; A.S.M.E. (American Society of Mechanical Engineers), 29 W. 39th St., New York, N. Y.

**H 62.16 Joints and connections.** (1) VITRIFIED PIPE. Joints in vitrified pipe shall be made of either a mortar or a jointing compound. In joining vitrified clay pipe the spigot of one pipe must be carefully centered into the bell of the next pipe. Joints shall be firmly packed with hemp, oakum or jute in such a manner as not to disturb the alignment of the pipes. When mortar is used it shall be composed of equal parts of Louisville or Portland cement with clean sharp sand thoroughly mixed with enough water added to give the proper consistency. The joints must be pointed carefully on the outside and the pipe left clean and smooth on the inside by drawing through a swab or scraper. Jointing compound shall be used in such a way as to permit the jointing compound to have the greatest unobstructed surface for pouring and adhesion. Care shall be exercised in placing the runner or snake to insure non-leakage during pouring and it shall not be removed until the compound is permanently set. The compound shall be poured continuously and as rapidly as possible until the joint is completely filled. Pipes shall be clean. All jointing compounds shall be approved by the board.

*Note:* The use of copper rings in cement joints is recommended. See H 62.22 (39).

(2) VITRIFIED TO IRON PIPE. Underground joints between vitrified and iron pipe shall be made the same as above required for vitrified pipe.

(3) CAST IRON PIPE. All joints in cast iron pipe and fittings shall be made by first inserting a roll of hemp, oakum or jute and thoroughly calking it in place, and then following with pure molten lead well calked, not less than one inch deep, lead to be brought to top of hub and faced. No paint, varnish or putty will be allowed on the joints until they have been tested.

(4) GALVANIZED WROUGHT IRON AND STEEL PIPE. Joints in galvanized iron pipe shall be standard screw joints, and all burrs or cuttings shall be removed. All screw joints shall be made with white or red lead, mineral paint, or other approved compounds, applied on outside thread. Not more than three threads of made-up joints shall be exposed, and they shall be protected by a coating of mineral or asphaltum paint or other approved compound, applied before the work is tested or inspected.

(5) BRASS PIPE. Joints on brass pipe shall conform to provisions of subsection (4) except that exposed threads require no coating.

(6) COPPER TUBE. All joints in copper water tube shall be made in a manner to insure a permanent water-tight joint. The joints shall be properly fluxed and made with approved solder. The joints shall be wiped clean to remove excess flux after the soldering operation has been completed. See H 62.15 (11).

(7) DISSIMILAR METALS. Connections between wrought iron or brass and cast iron shall be either a calked joint or a screw thread joint. Connections between lead and cast or wrought iron pipes shall be made with a calked joint, a soldering nipple or threaded joint. Wrought iron pipe connections shall be made with a right and left coupling, flanged union with durable gasket, a ground faced union or a running thread with lock nut made tight with wicking and red or white lead. Joints in lead pipe or between lead, brass or copper pipes shall be wiped joints except solder brazed or sweated joints on reamed, concave brass bushings in connection with exposed brass or lead traps. See H 62.22 (20).

(8) WASTE PIPE. (a) *Lead.* All lead under-floor waste pipes so far as practicable should be free from short bends. All branch joints in connection with water-carrying waste pipes should be of the sanitary "Y" pattern and all such joints should be so prepared and joined as to leave a clean interior, free from solder, obstructions or reductions of the respective pipe diameter. All lead waste pipes should be properly graded and substantially supported to guard against sagging or displacement and so installed that stoppages may be removed from any portion. To accomplish this, sink and basin traps should be so joined or connected to the waste pipes that they may be readily removed for wiring or rodding of the pipe throughout its entire length including waste branches thereof. Where lead closet bends are used, no water carrying waste pipe or branch shall be connected thereto. Where solder nipples are used in connecting to iron bends they should be straight bore of a size corresponding with the inside diameter of the waste pipe, but no such nipple should be less than 2 inches inside diameter. All lead bends should be so made as not to weaken the lead at the heel of the bend and all joints shall have a wall thickness of solder not less than three-sixteenths of an inch measured at the center of the pipe joint.

(b) *Screw thread.* All under-floor and concealed threaded waste pipes and fittings should be designed and constructed by the plumber to conform with the following minimum specifications: The waste piping for baths, sinks, basins and other similar fixtures shall be properly graded, free from short or unnecessary offsets, and all fittings shall be of the long radius sanitary pattern. Ends of all piping

shall be cut straight and reamed on the inside. The thread should be cut to the required length and depth and so made up that the end of the pipe extends to the recess receiving shoulder of the fitting. Where avoidable no 90 degree universal swing joints or any offset connection should be made. All changes in direction should be made by means of "Y"s or 5 $\frac{1}{8}$ ", 11 $\frac{1}{4}$ ", 22 $\frac{1}{2}$ ", 30, 45, 60, or 90 degree long radius pattern elbows. All ells and other fittings should be full bore and all such pipes and fittings should have a smooth interior.

(9) ROOF TERMINALS, FLASHING. The joint at the roof shall be made water tight by the use of copper, lead, galvanized sheet metal or iron plates or flashings. The flashing shall extend not less than 6 inches from the pipe. All flashings shall be substantially made and so placed as to insure a permanent tight joint. Roof flashings designed and constructed to provide an air space between the pipe and flashing to prevent freezing of soil and vent pipe terminals are recommended. See H 62.15 (9) (d), (12), H 62.22 (18).

(10) EARTHENWARE. The connections between soil pipe and fixtures of earthenware, vitreous china or enameled iron shall be made by means of a brass floor plate, not less than three-sixteenths inch in thickness, soldered or wiped to lead pipe, or an iron floor flange connection calked to iron pipe, or an iron or brass connection calked or screwed to wrought iron or steel pipe, with the fixture floor flange bolted to the floor connection with solid brass closet bolts. Floor joints shall be made air-tight with an asbestos graphite ring, asbestos or rubber gasket, or washer, or metal to earthenware, or metal to metal union. A paste of red or white lead or other equal compound may be used.

(11) OTHER TYPES. Any type of joint other than those specified in this code which the board approves may be used.

(12) PROHIBITED FITTINGS. Sanitary tees of short radius shall not be used except in connecting horizontal to vertical soil or waste pipes in which the flow is toward the vertical line. The use of one-fourth bends or elbows in soil or waste pipes is governed by H 62.15 (5), (8), H 62.22 (37), and (38). One-fourth bends with side or heel outlets except when they are made with "Y" or sanitary "T" branches, and all double hub fittings, double tees and double sanitary tees when used horizontally are prohibited, except when smaller pipes discharge into a larger pipe. Double hubs and double hub fittings may be used on rain water leader and vent lines. Offsets having less than one-fifth pitch will not be permitted. The use of a drive ferrule is prohibited and the use of combination lead ferrules will be permitted only when the calk joint can be made in the upright position. All waste and vent pipes must enter soil pipe by means of properly inserted fittings. The drilling and tapping of soil, vent and waste pipes and house drains to receive waste and vent pipes of any description is strictly prohibited, and in no case will the use of saddles or bands be permitted. No double hub or inverted calk joint shall be permitted in soil and waste lines. Whenever wrought or galvanized iron pipe connects with cast iron, soil waste or vent lines, tapped fittings or tap extension pieces shall be used except where pipe and hub are the same diameter.



**H 62.17 Repairs and reconstruction.** (1) **DEFECTIVE PLUMBING.** Whenever it shall appear upon inspection that any part of an existing plumbing system is defective, or fails to conform to the requirements of this code and by reason of such failure tends to create a nuisance, it shall be repaired, renovated, replaced or removed within 30 days, upon written notice from the state or local health officer.

(2) **FIXTURES REPLACED.** When an old or defective fixture is removed, to be replaced by a new one, and no other fixture or piping is to be added or remodeled, it will not be necessary to reconstruct the soil, waste or vent piping to make it conform to this code, unless the same is in a defective condition. In such cases, if found necessary, the fixtures shall be provided with efficient deep seal traps or deep seal resealing traps of the self-scouring centrifugal type.

(3) **RECONSTRUCTION.** When old or defective plumbing is to be remodeled, additional fixtures installed or the whole plumbing system moved to another part of the building the remodeled system shall be made to conform to this code.

(4) **OLD MATERIALS RE-USED.** All fixtures, soil, waste, and vent pipes removed from an old building, if found to be in good condition, may be used in the same building or may be used in another building, provided they are approved by the board or local plumbing inspector and the owner of the building in which they are installed gives his written consent.

(5) **OLD HOUSE DRAINS.** Old house drains may be used in connection with new buildings or new plumbing only when they are found on examination or test to conform to the requirements of this code governing new sewers and drains. If the old work is found defective, the local or state inspector shall notify the owner of the changes necessary to make it conform to the requirements of this code.

(6) **REPAIRS.** All repairs to fixtures or piping shall be done in a substantial, sanitary and workmanlike manner.

**H 62.18 Water supply systems.** (1) **WATER SERVICE.** (a) *Size.* The water service pipe to any building shall be of sufficient size to permit a continuous ample flow of water under maximum simultaneous use to all fixtures and points of service. The minimum diameter of the service pipe shall be five-eighths inch.

(b) *Materials.* The service pipe from a main or from the pump of a privately owned supply to any building shall be copper water tube, lead, brass, cast iron or galvanized steel or wrought iron pipe.

(c) *Valve controls.* Service controls shall include a valve or shut-off at the main, a curb stop or valve at the curb or privately owned pump, and a valve or stop inside the foundation wall of each building.

(2) **BUILDING DISTRIBUTION SYSTEM.** (a) *Size.* The water supply piping shall be three-fourths inch in diameter for iron or brass pipe. The diameter of any riser or branch serving more than one plumbing fixture or appliance shall not be less than three-fourths inch for iron or brass pipe. The diameters of branches to single fixtures shall not be less than one-half inch except that three-eighths inch pipe not to exceed 5 feet in length may be used to supply water closet tanks, lavatories or similar fixtures. If copper water tube is used

the minimum pipe diameters given above may be decreased one standard copper water tube size, except the minimum pipe diameter shall be three-eighths inch.

(b) *Materials.* All water supply pipes within a building shall be of lead, galvanized wrought iron or steel, brass, or cast iron, with brass or galvanized malleable iron fittings, or copper water tube and fittings. No pipe or fittings that have been used for other purposes shall be used for distributing water for drinking or domestic supply purposes. See H 62:16.

(c) *Supports.* All piping shall be supported to prevent undue strains upon connections or fixtures, and shall be so aligned and graded that the entire system or parts thereof can be controlled and drained. The formation of traps or sags in water piping shall be avoided where possible. When unavoidable such sags, traps or inverts shall have provisions for properly draining same.

(d) *Valve controls.* Controls within a building shall include a valve or compression stop for each lawn sprinkler, hot water tank, water closet, urinal and point of entrance of the water service. In a multiple dwelling or public building a valve shall also be provided at the base of each riser and for each dwelling unit or public toilet room unless served by an independent riser, and for each branch serving fixtures in the basement.

(e) *Water supply to fixtures.* All plumbing fixtures shall be provided with a sufficient supply of water for flushing to keep them in a sanitary condition. Every water closet shall be flushed by means of an approved tank or flush valve, of at least 4-gallon flushing capacity and at least one gallon for each urinal. The water from flush tanks shall be used for no other purpose than to reseal drain traps. See H 62.12 (8), (9).

(f) *Air chambers.* Each water supply riser and fixture branch shall terminate with an air chamber, the diameter of which shall be not less than the riser or branch it serves, and where possible it shall have a length not less than 24 times the diameter of such riser or branch. In general, air chambers or approved shock absorbers shall be so located and of sufficient size to prevent undue water hammer.

(g) *Relief valves.* Relief valves shall be provided on all domestic hot water boilers or storage tanks of the closed type. No valve of any type shall be placed between the relief valve and a hot water boiler. The relief valve shall be installed at or within 18 inches of a boiler or hot water tank. The discharge pipe from the relief valve shall terminate in an open fixture or not more than 10 inches from the floor as close as possible to a drain properly connected to the house drain or house sewer. No thread shall be permitted at the end of such discharge pipe. The valve shall be an effective relief valve with non-corrosive seat and be of the diaphragm or bellows type which has been certified by a recognized testing laboratory or approved by the board. Relief valves should be provided on all private water systems using displacement type pumping equipment.

(h) *Protection against frost.* All water pipe, storage tanks and flushing tanks subject to low temperatures shall be effectively protected against freezing.

(3) **SPECIAL EQUIPMENT.** (a) *Separate piping for each source.* A water supply that meets accepted standards of purity for human consumption shall be distributed through a piping system entirely independent of any piping system conveying another water supply.

(b) *Piping by plumber.* In municipalities having public water supply and sewerage systems or in any area platted under ch. 236 adjacent to such municipalities and in metropolitan sewerage districts, no person not licensed by the board as a master plumber or as a journeyman plumber shall install any piping for water supply to any system designed for steam power, heating, temperature regulation, automatic fire protection, hydraulic power, or for any special water usage for industrial or manufacturing purposes. All such piping for supplying water for any system for steam power, heating, temperature regulations, automatic fire protection, hydraulic power, or for any special water usage for industrial or manufacturing purposes, shall be installed by the licensed plumber to the appliance forming the unit or initial point of such system and shall terminate with a valve, located at the unit or appliance to be connected.

(c) *Piping by equipment installer.* The connection of appliances forming the initial unit of such systems, to the water supply pipe installed by the licensed plumber, as prescribed by rules and regulations, may be made by the person installing such aforesaid systems, but the connection of the water supply shall be made in a manner to prevent the possibility of contamination of the water supply by the backflow of water from such systems by siphonage, drainage, or force.

(4) **PRIVATE SYSTEMS.** (a) *Source.* All private water supplies shall be uncontaminated and the source shall conform in construction with the specifications of the Wisconsin well construction and pump installation code. All supplies known to be subject to occasional pollution shall be either discontinued or made safe as directed by the board.

(b) *Capacity.* All private water supply systems, pumps, and water pressure storage tanks serving residences or public school and similar buildings shall be of sufficient capacity and size, and shall have sufficient pressure and volume of water to provide adequate flushing facilities in order to maintain the plumbing fixtures and appliances in a sanitary and good operating condition at all times.

*Note:* For detailed information and specific rules and regulations governing the location, construction of wells, setting of pumps, sealing of well top, see the Wisconsin well construction and pump installation code adopted by the board pursuant to ch. 162, Wis. Stats.

**H 62.19 Back siphonage and cross connections.** (1) **PROHIBITED FIXTURE INSTALLATIONS.** No closet bowl or other fixture equipped with a flushometer valve shall be installed with a side or rear spud located below the lower part of the flush rim of the bowl.

(2) **PROHIBITED COMBINATION FAUCET USE.** No faucet or combination faucet or like appliance so installed as to form a cross connection directly or indirectly between a safe drinking water and an unsafe or questionable water supply shall be permitted.

(3) **PROHIBITED WATER—DRAINAGE SYSTEM INTERCONNECTION.** No direct plumbing fixture or pipe connection shall be made between any

part of the water supply system and any part of the plumbing drainage system or impure water supply system unless adequately protected against back-siphonage.

(4) PROTECTION FROM BACK-SIPHONAGE. (a) *Fixture inlets.* All fixture water supply inlets of every description shall be located and designed so as to prevent the possibility of back-siphonage or back-drainage of any of the fixture contents into the water supply lines.

(b) *Inlet elevation.* Whenever possible the water supply inlet shall terminate at least two pipe diameters but not less than one inch above the maximum possible water level of the fixture, tank or vat so as to prevent the possibility of back-siphonage.

(c) *Vacuum-breaker.* If the water supply inlet cannot be raised above the maximum possible water level, an approved type of vacuum-breaker shall be installed between the control valve and the fixture in such manner that no back-siphonage is possible under any degree of vacuum in the water lines and with water in the fixture at the maximum possible water level. For positive protection each such fixture shall have a vacuum-breaker installed 4 inches above the maximum water level.

(d) *Maximum water level.* The maximum possible water level referred to heretofore shall be construed as the height to which water can rise in a fixture, tank or vat before it flows freely into the open atmosphere above the fixture rim or through adequate size openings so designed as not to be obstructed by debris or waste matter.

(e) *Impure liquids.* Fixture contents against which back-siphonage protection shall be maintained include all polluttional material, sewage, waste water, processing liquids, chemicals, and all water and other liquids which can be polluted at some time or other.

(5) SPECIAL EQUIPMENT PROTECTION. All water supply equipment and appliances serving special fixtures shall conform with the intent and purposes of this section. Any unusual use for water, as for air-conditioning equipment, hydraulic elevators, presses, fountains, etc. shall be given special consideration in relation to possible pollution of the pure water supply system.

(6) IMPROPER LOCATION OF SEWERS AND DRAINS. Sewers and drains shall never pass directly over water tanks or any place where drinking water, ice, or food is prepared, handled, or stored.

(7) DUAL WATER SUPPLIES. The maintenance of a pressure system of water supply whose purity is questionable, such as cistern water, in the same building in which a pure water supply exists is discouraged, especially if the water is piped throughout the building and not confined to a certain section for special uses or processing. The piping containing such impure water supply shall be painted red and properly labeled at intervals. Under no circumstances shall the two supplies be cross-connected or provision made for their cross-connection. No cross-connection shall be made between piping connected to a public water supply system and piping of a private water supply system. See H 62.22 (40).

**H 62.20 Sewage treatment and disposal systems.** (1) SEWAGE TREATMENT TANKS. (a) *Allowable use.* Septic or other sewage treatment tanks may be constructed where no public sewerage system is available or likely to become available within a reasonable time.

(b) *Permission to construct.* In cities, villages, and sanitary districts permission to construct sewage treatment systems shall be obtained from the local plumbing inspector or local health officer.

(c) *Location.* No sewage tank shall be located within 2 feet of any lot line, 10 feet of any cistern or 25 feet from any well or other source of water supply used for domestic purposes. Where practicable greater distances should be provided.

(d) *Materials.* Septic tanks shall be water-tight and built so as to constitute a separate structure. They shall be made of metal, concrete, precast concrete, or vitrified clay. Metal tanks shall be made of new, hot rolled commercial quality steel or equally suitable metal with a minimum thickness of 0.0747 inches. (No. 14 manufacturers gauge for sheet steel.) Such tanks shall be constructed and coated, inside and outside, in compliance with the latest revision of the U. S. Department of Commerce commercial standard 177. Each tank shall be clearly marked with the name and address or registered trade mark of the manufacturer. Precast concrete tanks shall have a minimum wall thickness of 2 inches.

(e) *Capacity and design.* 1. The size of a septic tank shall be based on the number of persons using the building to be served. The minimum liquid capacity of a septic tank measured below the outlet shall be 500 gallons for any installation. The liquid depth shall not be less than 3 feet nor more than 6 feet. The total depth of tank shall be at least 8 inches greater than the liquid depth. For each additional person over six to be accommodated in a dwelling unit, the liquid capacity shall be increased by 60 gallons (8 cubic feet). For schools and other part time use buildings where more than 20 persons are to be served, the capacity of the tank shall be increased above the minimum size by 15 gallons (2 cubic feet) per additional person. Where garbage disposal units are connected to the plumbing system, the septic tank shall be increased 50 per cent over that otherwise required. Where large volumes of other wastes are tributary to the tank the capacity shall be increased to provide a two day holding period. See H 62.22 (41), (42), (43).

2. Rectangular tanks shall have a minimum width of 30 inches and shall be constructed with the longest dimensions parallel to the direction of flow. All single compartment cylindrical tanks shall have an inside diameter of not less than 48 inches. Each section of a multi-compartment tank shall have a minimum length, width or diameter of 24 inches. Where tile or similar other pre-cast sections are used in the construction of multi-compartment tanks they shall all be mounted upon and cemented to a single concrete base.

3. The inlet and outlet on all tanks or tank compartments shall be provided with open-end sanitary tees or baffles constructed to distribute flow and retain scum in tank or compartments. The tees or baffles shall extend at least 6 inches above and 9 inches below the liquid level. The inlet and outlet arrangements shall provide for free flow of air between inlet and outlet.

4. Each single compartment tank and each section of a multi-compartment tank shall be provided with at least one manhole extending to within at least 12 inches of the ground. Manhole openings shall be at least 20 inches square or 20 inches in diameter and be provided with substantial concrete, stone or cast iron covers.

5. The discharge of surface, rain, and other large volumes of clear water into a treatment tank is prohibited.

(f) *Maintenance.* All sewage treatment tanks must be cleaned out whenever the sludge contents rise to a point where they occupy one-third of the cubic contents of the tank. Sludge removed from a sewage treatment tank or its units must be hauled away, buried or disposed of in such a manner as not to create objectionable conditions or cause a nuisance. The sludge shall not be disposed of into any lake, stream or other water course.

(2) **EFFLUENT DISPOSAL.** (a) *Location.* The effluent from septic tank shall be disposed of by soil absorption in a seepage pit, drainage field or by some other manner approved by the board provided such disposal does not create a nuisance or hazard to health. All soil absorption disposal units should be located at a point lower than the grade of any nearby water well and unless permission is obtained from the board shall be located not less than 50 feet from any dwelling or cistern and not less than 50 feet from any water well constructed in accordance with the specifications of the Wisconsin well construction and pump installation code. Where water wells do not conform greater distances shall be maintained. No part of a seepage pit or drainage field shall be located within 5 feet of any lot line or within 25 feet of any lake, stream or other water course unless permission is obtained from the board.

*Note:* In cases where well construction is unsatisfactory it is impossible to specify a safe minimum distance from the sewage disposal system. In such cases it is desirable that the well be reconstructed or replaced.

(b) *Seepage pits.* Seepage pits preferably should be used when deeper soil formations are more porous than the upper soil. The seepage pit shall consist of a chamber walled up with material which allows water to percolate through it, such as dry rubble, brick or concrete blocks. The bottom shall be left open to the soil. The seepage pit shall not be less than 6 feet in diameter and should have a depth, where practicable, of 6 feet or more below the inlet pipe, depending on the character of the soil. The capacity of this compartment shall be such as to provide one square foot of percolating surface (including bottom) for every one to 5 gallons of water per day. The larger capacity is to be taken for the more compact soil and the lower capacity for sand and gravel. Seepage pits shall not extend into creviced rock formations. Each seepage pit shall be provided with a manhole and a fresh air inlet. The manhole shall be at least 20 inches square or 20 inches in diameter extending to within at least 12 inches of the surface of the ground and be provided with a substantial concrete, stone or cast iron cover. See H 62.22 (41).

(c) *Drainage tile and siphon.* 1. Drainage tile should be used in place of a seepage pit wherever possible, particularly when the deeper soil tends to be non-porous. In tight soils the percolating tile lines should be surrounded with coarse gravel, crushed rock, or cinders, having a depth below the tile of at least 12 inches. The tile should be laid 12 to 36 inches below the surface and in straight or curved parallel lines separated by 10 feet or more. The tile should be laid on a slope of about 2 inches per 100 feet. Tile should be spaced about one-fourth inch apart and be blinded at the tops with tar paper or broken tile unless surrounded with coarse material in which case

Am Register June, 19 56 1. 2. 3. a b and 4 added

the surface of the material should be covered with tar paper or equal. See H 62.22 (44), (45).

2. The length of tile and width of absorption bed shall be based on character of soil and number of persons served, ranging from a minimum of 20 feet of tile per person for soils well adapted to absorption to 100 feet or more per person for tight soils.

3. Discharge of septic tank effluent into the soil absorption system should preferably be regulated by an automatic siphon. The dosing tank in which the siphon is situated should have a capacity equal to the combined volume of the tile in the absorption system.

*Note:* Each foot of 3-inch drain tile has a capacity of .367 gallons; 4-inch tile, .652 gallons; 5-inch tile, 1.02 gallons; 6-inch tile, 1.46 gallons; 7-inch tile, 2.012 gallons; 8-inch tile, 2.599 gallons; 10-inch tile, 4.0195 gallons; 12-inch tile, 5.875 gallons. The amount of tile required is governed by the lay of the land and character of the soil. This is important and must receive careful attention. The drainage tile should be laid at a depth of one foot or more below the surface of the ground, and in cases where it is necessary to lay the tile deeper than two feet, an adequate system of ventilation should be provided.

(3) VENTILATION. Fresh air inlets shall be provided on all soil absorption systems and be placed so as to assure a free flow of air throughout the entire installation. The vent pipes shall be at least 2 inches in diameter and extend at least 12 inches above the ground surface with a return bend fitting. Fresh air inlets shall be located at least 20 feet from any window, door or air intake of any building used for human habitation. See H 62.22 (41), (45).

*Note:* Free circulation of air as provided for in this section means air entering through one or more fresh air inlets, passing on through the units and piping in connection therewith, thence through the inverts of the septic tank by means of the vent openings, and the air continuing onward through the house drain, soil, waste and vent pipes to a point above the building, thus not only creating an effective circulation of air but conveying all offensive odors and gases to a point above the roof.

(4) CESSPOOLS PROHIBITED. Seepage pits for disposal of untreated sewage are prohibited.

(5) SEWER CONNECTION. Private systems for sewage disposal must be discontinued when public sewers become available. The house sewer shall be disconnected from the old system and be reconnected with the public sewer. All abandoned septic tanks and seepage pits shall be immediately filled.

(6) INDUSTRIAL WASTES. Treatment and disposal systems for industrial wastes shall be designed to meet the individual needs and be of a type that will adequately purify the specific waste. Owners of industrial establishments producing trade wastes of a toxic, putrescible, or otherwise objectionable character should consult with the board in reference to their problems.

**H 62.21 Inspection and tests.** (1) STATE APPROVED INSTALLATIONS. Plumbing installations in newly annexed territory complying with the requirements of the state code shall be approved by the local governing body of the municipality of which such territory becomes a part, and the owner of the property shall be granted permission to connect to the public water supply and sewerage system upon the payment of permit fees where such fees are required.

(2) LOCAL INSPECTION. (a) *Testing.* All piping of a drainage or plumbing system in cities and villages having local plumbing super-

visors, except in case of repairs as specified in H 62.21 (6), shall be tested by the plumber in charge, in the manner herein provided, in the presence of the local supervisor of plumbing or his authorized deputies. The material and labor for tests shall be furnished by the plumber in charge.

(b) *Notice for inspection.* The plumber in charge or the owner of the property in case no plumber is employed, shall notify the supervisor in person, by telephone or in writing when the work is ready for inspection. If the inspection is not made within a reasonable time after the notice is given, the plumber in charge, or the owner, may proceed with the work.

(c) *Preparations for inspection.* When work is ready for inspection the plumber in charge, or in case none is employed, the owner, shall make such arrangements as will enable the supervisor to reach all parts of the building readily, shall have present the proper apparatus and appliances for making the tests, and shall furnish such assistance as may be necessary in making proper inspection.

(d) *House drain tests.* The entire house drain with all its branches, receptacles and connections shall be brought so far as practicable to the surface or grade of basement floor and tested with water or air. Upon being found free from defects and leaking joints, the test shall be considered satisfactory.

(e) *Stable and garage tests.* If a stable, garage or any part thereof is used for human habitation, or is so constructed that it may be used as such, the same tests shall be made as for an ordinary dwelling.

(f) *Rain leader tests.* Rain water leaders and their roof connections where they are permitted within the walls of any building, and such branches as connect with the house drain 3 feet beyond basement wall shall be tested with water or air.

(g) *Soil, waste, and vent tests.* Soil, waste and vent pipes, rain water leaders and all work known as "roughing in and underfloor work" between the house drain connections to points above the finished floor and beyond the finished face of walls and partitions shall be tested.

(h) *Water and air test.* The water test shall be applied by closing all openings in the pipes with proper testing plugs, to the highest opening above the roof, and completely filling the system with water, or an air test with pressure of at least 5 pounds shall be used. If the pipes are found free from defects and leaking joints, the test shall be considered complete and satisfactory. Buildings five stories or more in height may be tested in sections as directed by the plumbing supervisor.

(i) *Smoke test.* The smoke test shall be used in testing the sanitary condition of the drainage or plumbing system of all buildings where there is reason to believe it has become dangerous or defective. The smoke machine shall be connected to any suitable opening or outlet in the system. When the system is filled completely with dense pungent smoke, all openings emitting smoke, the openings shall be closed and an air pressure equivalent to a one-inch water column applied for a



period of at least 10 minutes. If there is no leakage or forcing of trap seals, the systems shall be considered air and gas tight. Nothing, however, in this section shall be construed to prohibit the removal of any clean-out or the unsealing of a trap to ascertain if the smoke has reached all parts of the system.

(3) **COVERING OF WORK.** No part of any plumbing or drainage system shall be covered until it has been inspected, tested and approved. If any part is covered before being tested and approved, it shall be uncovered at the direction of the supervisor.

(4) **FINAL INSPECTION.** When the plumbing or drainage system is completed and fixtures are installed the final inspection shall be made.

(5) **INSPECTION FOR CHANGES OR ALTERATIONS.** When additional fixtures are installed or the style or location of any fixture is changed or when changes are made in the piping system, the work shall be inspected.

(6) **TESTS FOR REPAIRS.** Inspections may be made, but tests shall not be required after the repairing or replacing of any old fixture, faucet or valve by a new one to be used for the same purpose, forcing out stoppage, repairing leaks or relieving frozen pipes and fittings. Such repairs or alterations may not be construed to include cases where new vertical or horizontal lines of soil, waste, vent, or interior rain water leaders are used or their relative locations changed. In a building condemned by the proper authorities because of insanitary conditions of house drainage or plumbing, such repairs or alterations as are necessary to make the plumbing sanitary shall be made to conform to the provisions of this code. Tests and inspections of such alterations shall be made as for new buildings.

*Note:* No test nor inspection shall be required where a house drainage and plumbing system or part thereof is set up for exhibition purposes; nor shall a test be required (although inspection may be made) where the plumbing is placed in an out-house, stable or detached building used exclusively for such purpose.

(7) **DEFECTS IN MATERIALS.** If tests or inspection discloses defective material, leakage, or unworkmanlike construction, which does not conform to the requirements of this code, and which is condemned by the supervisor of plumbing the same shall be removed and replaced within three days, and when necessary retested. The presence of any foreign substance, other than that provided for in this code, about a joint or any part of a plumbing or drainage system shall be sufficient cause for condemning such joint or part of the system. Any split fittings, hubs or defective material which do not conform to the requirements of this code, and which have been condemned by the supervisor, shall be removed from the work and not used again.

*Note:* Poor workmanship design or methods of installation likewise shall be sufficient cause for the condemnation of the whole or any part of the system.

**H 62.22 Sketches.** The following charts and sketches illustrating methods of making plumbing and drainage installations shall be followed wherever applicable.

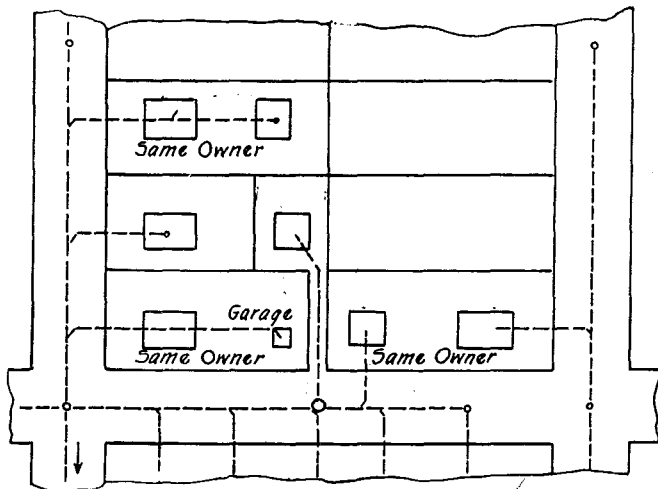

(1) Illustrating provisions of H 62.04 (1).

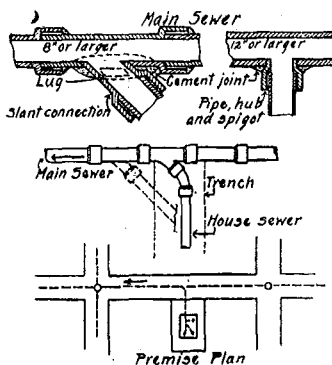

(2) Illustrating method of connecting house sewer to main sewer. H 62.04 (6).

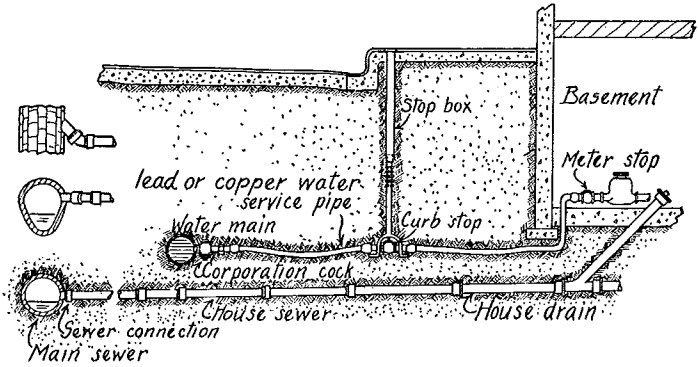

(3) Typical installation of house drain to point within building. H 62.05 (1).

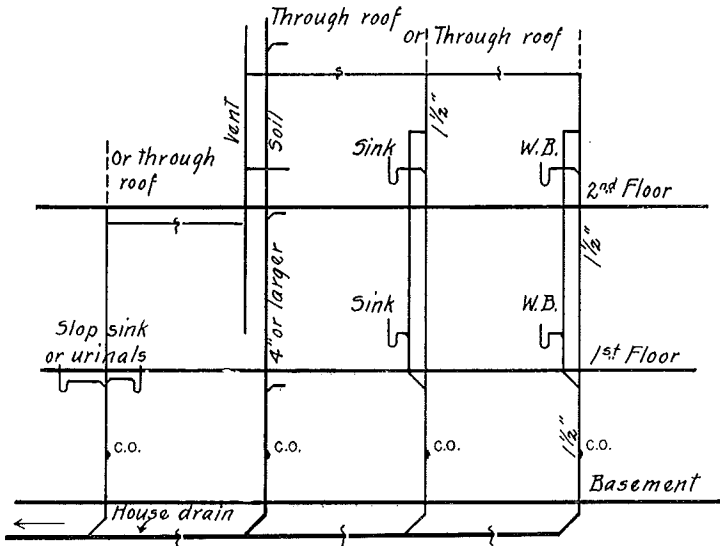

(4) Illustrating permissible waste stacks and vent connections. H 62.06 (1).

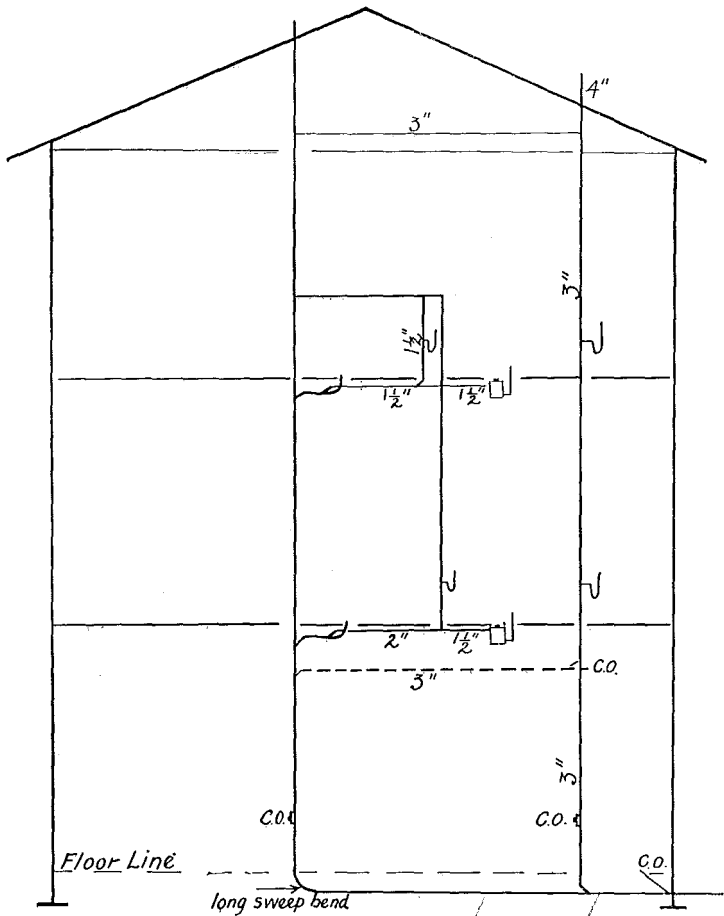

(5) Illustrating permissible method of bathroom and sink waste and vent installation. H 62.06 (1), H 62.07 (8).

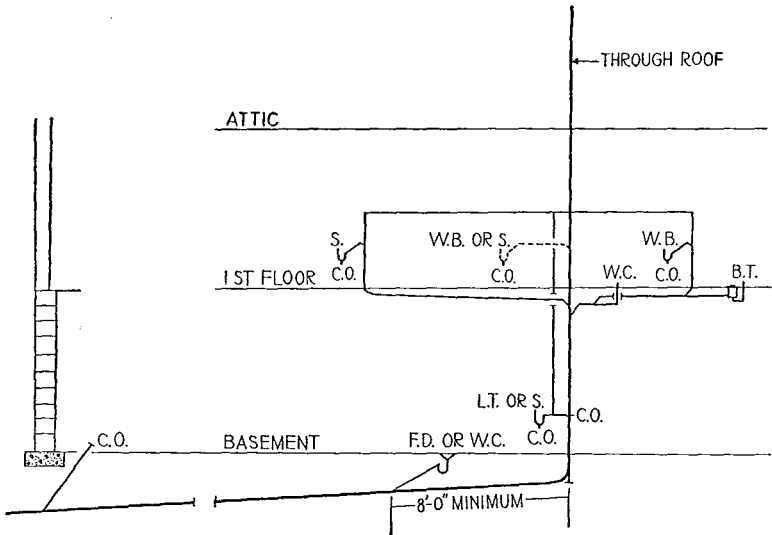

(6) Illustrating minimum requirements for typical one-story building installation. H 62.06 (1), H 62.07 (6), (7) (b).

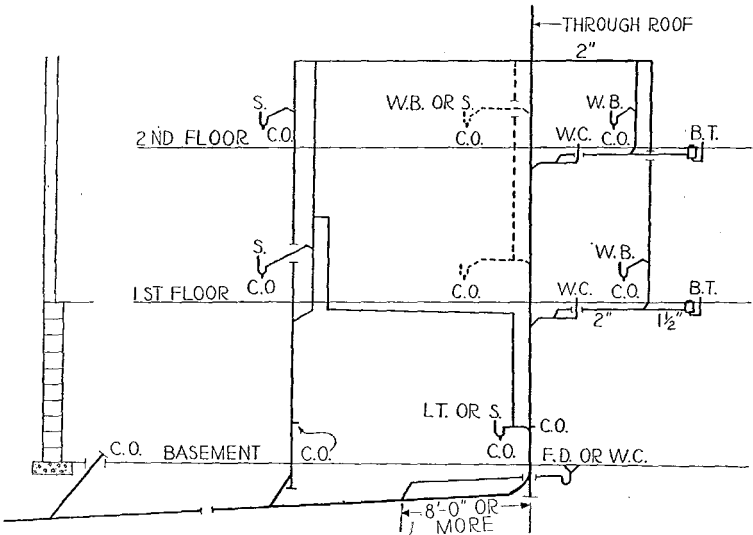

(7) Illustrating minimum requirements for a two-story residence or similar installation. H 62.06 (1), H 62.07 (6), (7) (b).

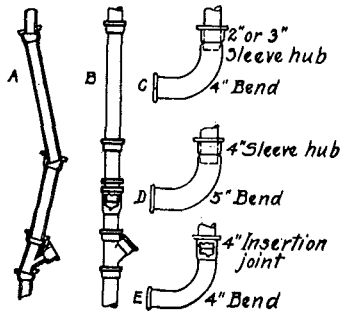

(8) A and B illustrate methods of inserting soil pipe fittings or joining cast iron pipe; C, D and E suggest methods of connecting soil, waste and vent stacks to underground house drains. H 62.06 (3).

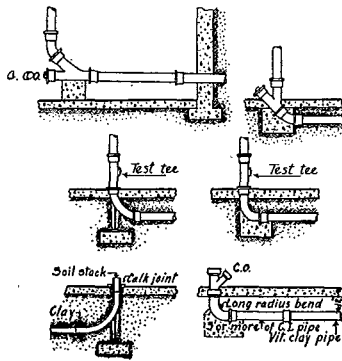

(9) Showing methods of supporting soil pipe stack at their base. H 62.06 (3), (6).

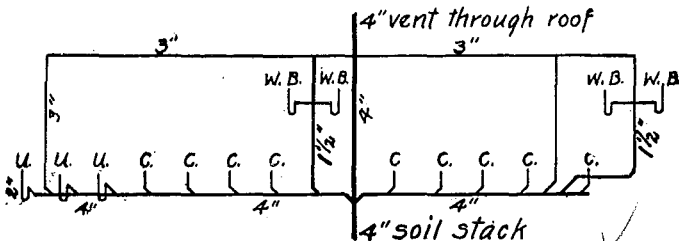

(10) Showing typical toilet room installation. H 62.07 (2) (b) (c).

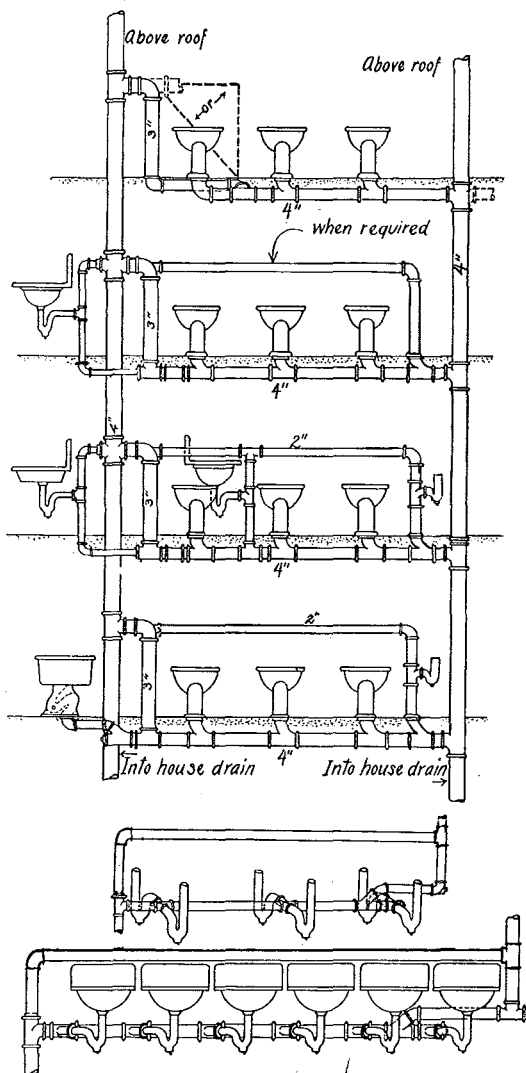

(11) Illustrating method of circuit or continuous venting. H 62.03 (1), (3); H 62.06 (5); H 62.07 (2) (b), (c); H 62.08 (1).

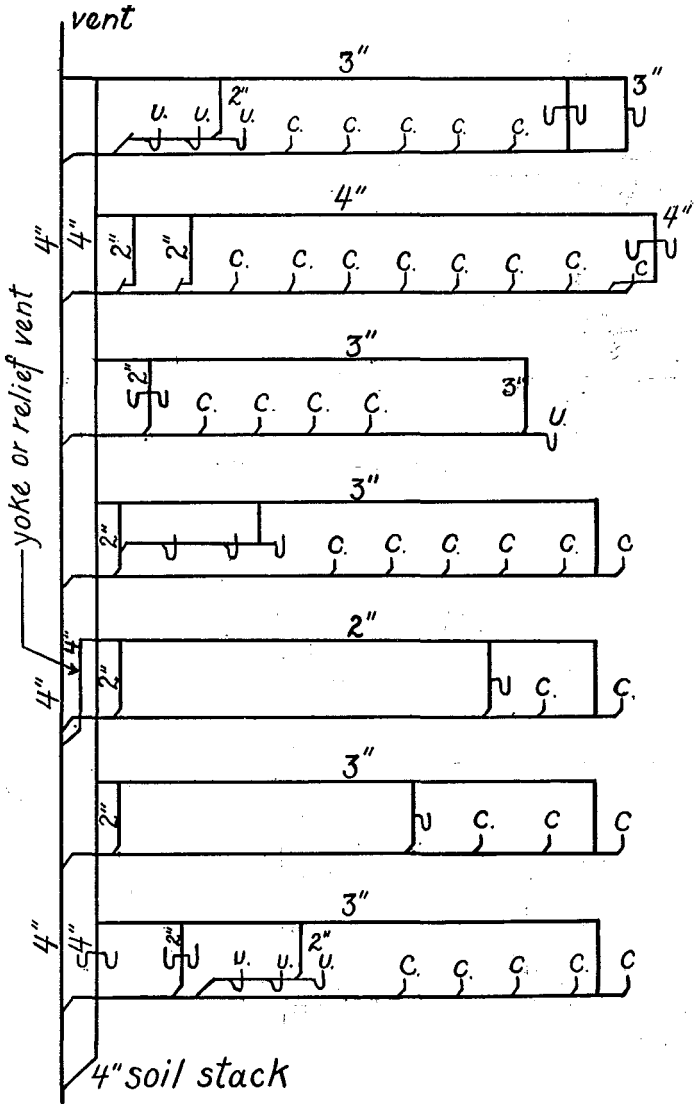

(12) Illustrating typical and various alternative methods of soil, waste and vent piping for tall buildings, including yoke vent. H 62.03 (1), (2); H 62.06 (5); H 62.07 (2) (b), (c), (3).



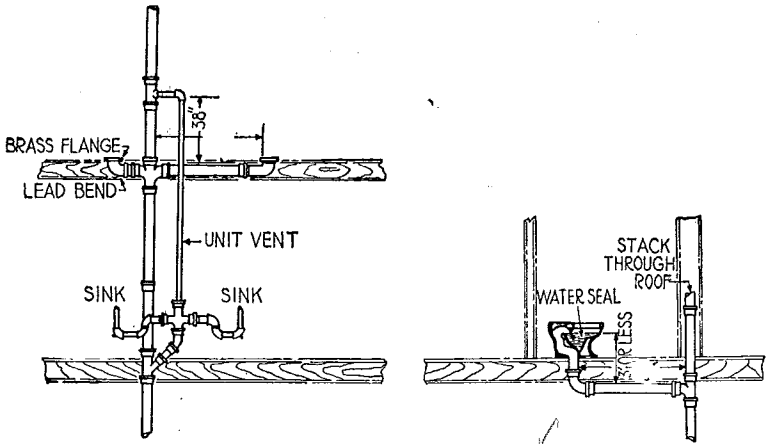

(13) Illustrating provisions of H 62.07 (4).

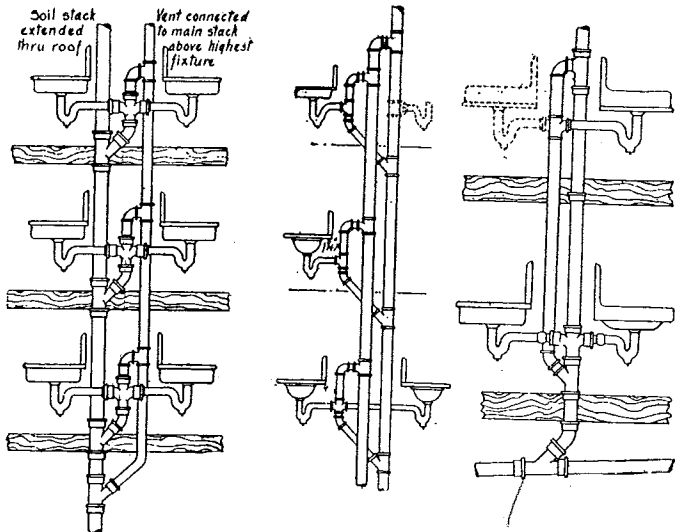

(14) Illustrating provisions of H 62.07 (4).

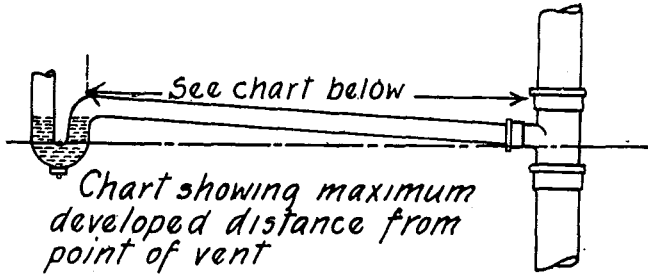

| Size of Pipe | Max. Total Grade | Max. Developed Dist. |
|--------------|------------------|----------------------|
| 1 1/4 inch   | 1 1/4"           | 2'-6"                |
| 1 1/2 inch   | 1 1/2"           | 3'-0"                |
| 2 inch       | 2"               | 4'-0"                |
| 3 inch       | 3"               | 6'-0"                |
| 4 inch       | 4"               | 8'-0"                |

(15) Chart showing maximum developed distance from point of vent. Grade (pitch) not to exceed the inside diameter of the waste branch. H 62.07 (6).

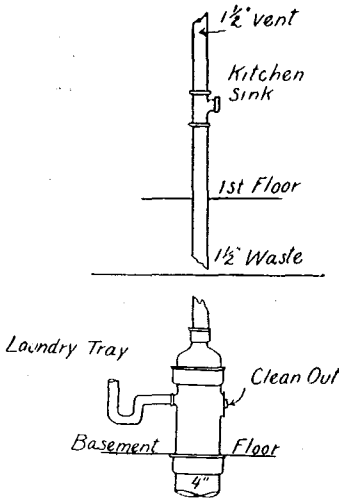

(16) Showing typical laundry tub and kitchen sink installation for single family residence using 1 1/2 inch diameter cleanout plug. H 62.07 (8).

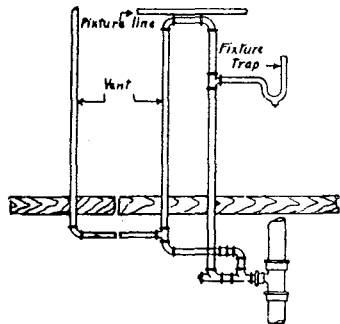

(17) Illustrating method of installing loop vent. H 62.07 (10).

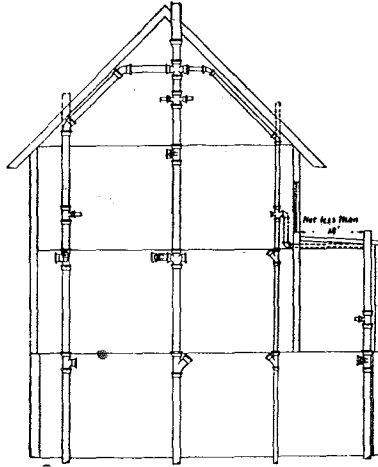

(18) Showing permissible roof terminals and distance from window. H 62.07 (1), (12).

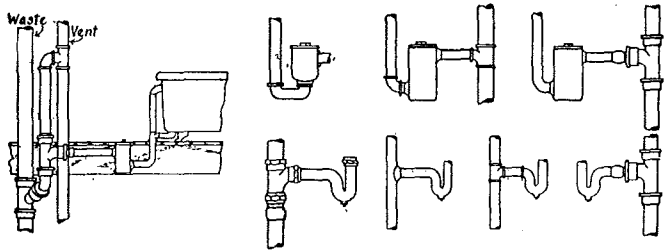

(19) Showing typical traps and methods of back-venting. H 62.07 (6), H 62.08 (1).

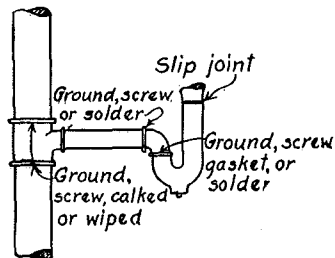

(20) Showing permissible joints in connection with traps. H 62.08 (3) (a), H 62.16 (7).

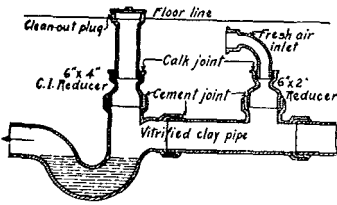

(21) Illustrating vitrified clay main house trap, cleanout, and fresh air inlet installation. H 62.08 (5), H 62.09 (1) (b).

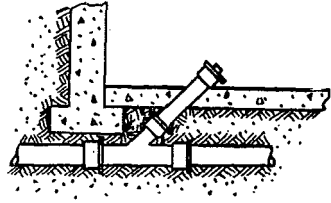

(22) Illustrating main house drain cleanout plug. Required whether drain enters building below or above floor. H 62.09 (1) (b).

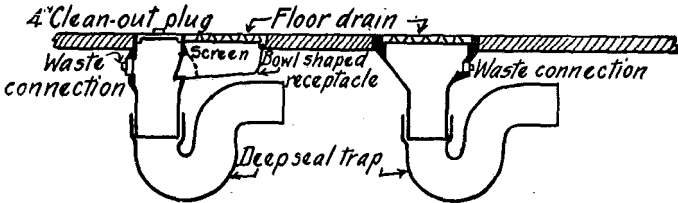

(23) Showing typical floor drains. H 62.10 (1).

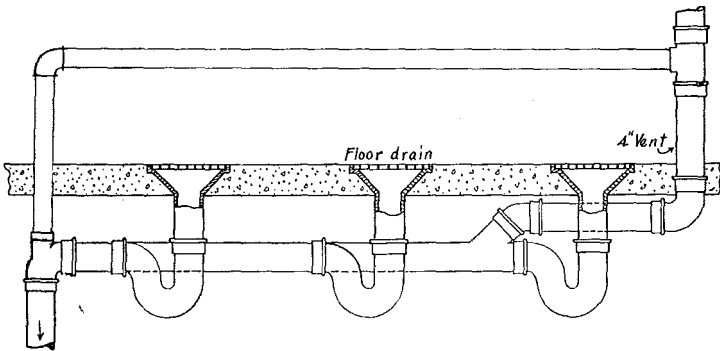

(24) Showing circuit waste and vent method of floor drain installation. H 62.07 (2) (b), H 62.10 (2).

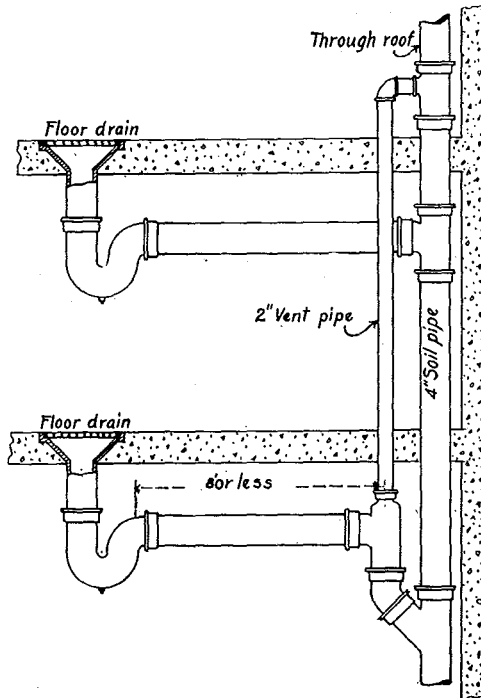

(25) Illustrating individual vent method of installing a floor drain. H 62.10 (2).

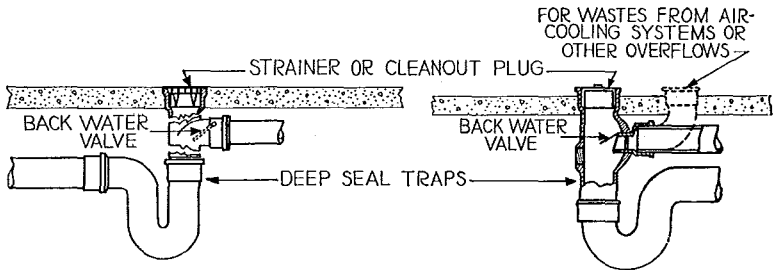
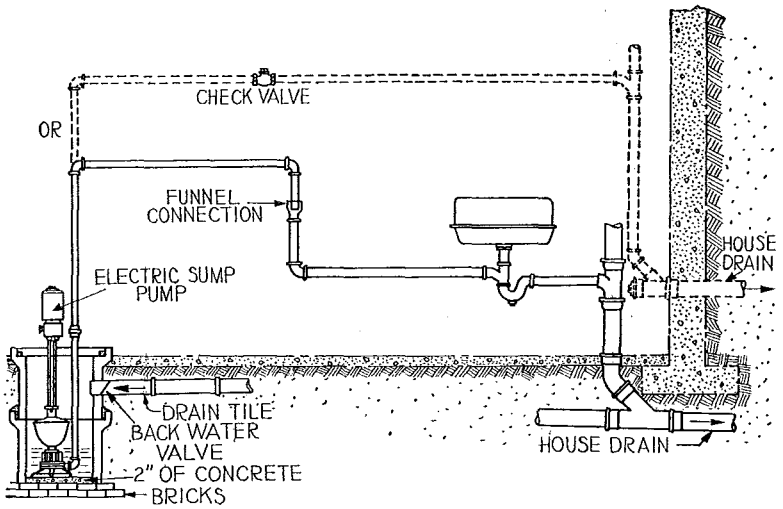

(26) Showing subsoil receiver and methods of installation. H 62.10 (4).

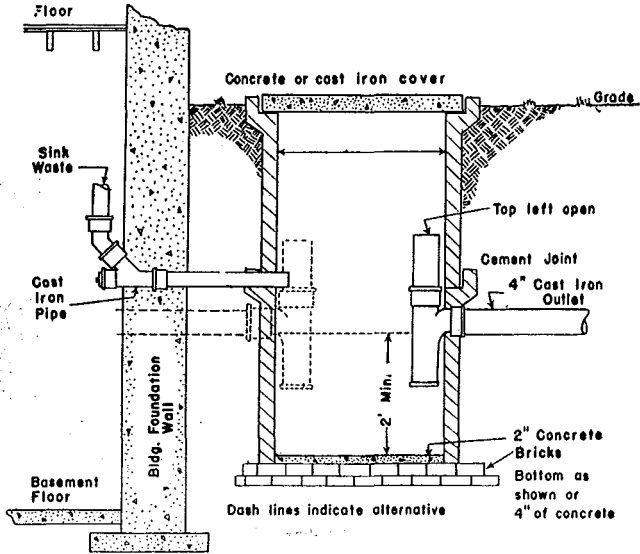

(27) Showing design of drainage piping and grease basin. H 62.11 (2) (b), (d).

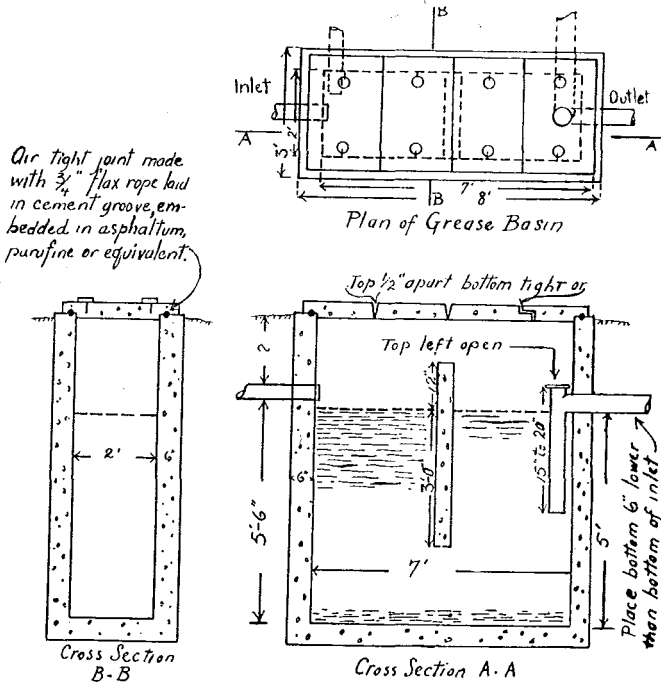

(28) Showing the design of a large grease basin in connection with hotels, restaurants or institution kitchens. H 62.11 (2) (b).

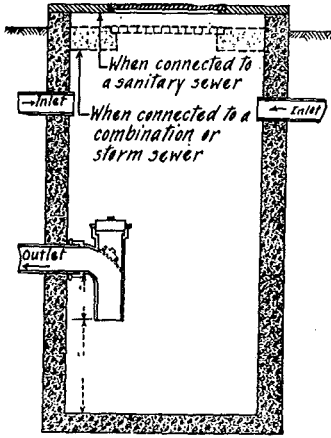

(29) Showing typical outdoor catch basin. H 62.11 (3), (4).

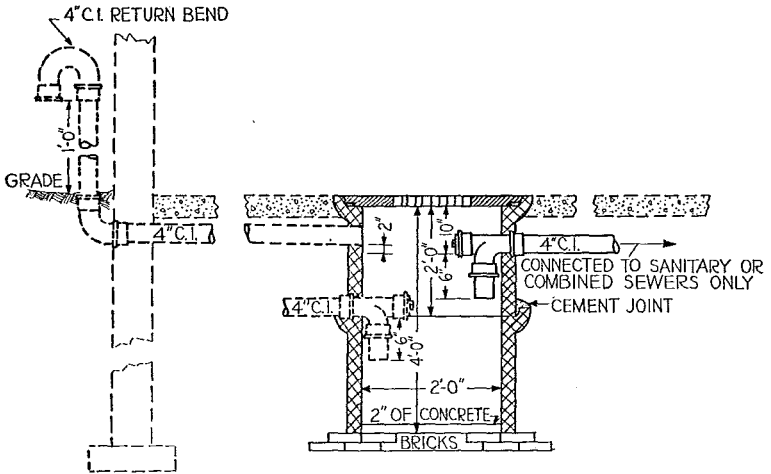

(30) Showing typical garage catch basin. Dash-lines indicate alternative. H 62.11 (5).



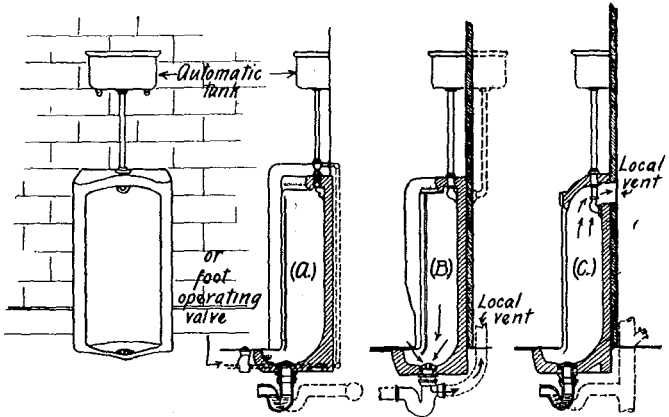

(31) Showing individual urinal set into the floor.  
H 62.09 (2), H 62.12 (9).

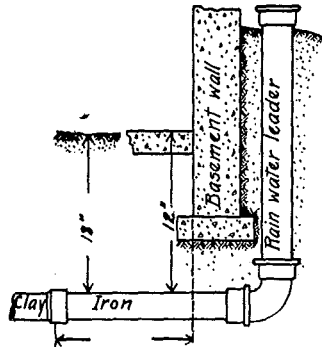

(32) Illustrating method of installing rain water leaders.  
H 62.13 (2) (e).

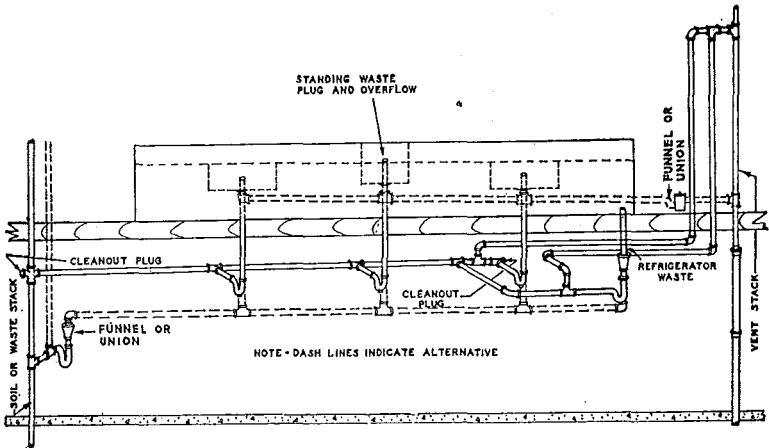

(33) Outlining methods of connecting bar, soda fountain, and similar fixtures. H 62.14 (2).

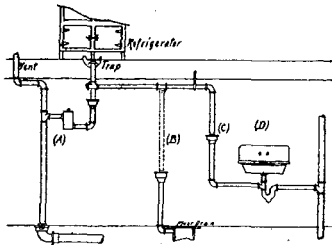

(34) Illustrating methods of connecting refrigerator wastes. H 62.14 (3).

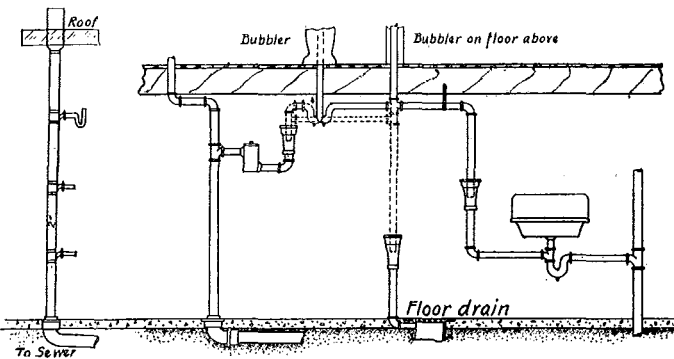

(35) Illustrating four approved methods of connecting drinking fountain wastes. H 62.07 (8), H 62.14 (5).

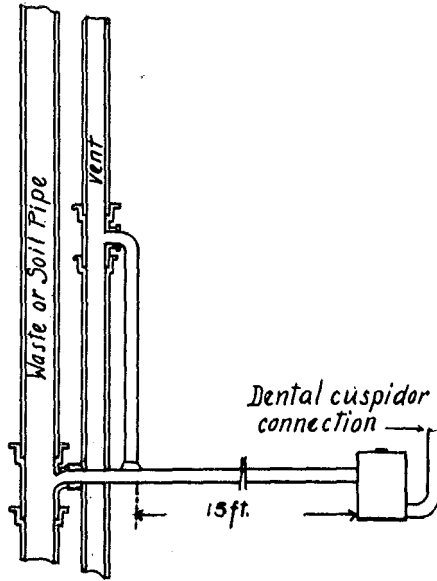

(36) Illustrating a dental cuspidor installation. H 62.14 (6).

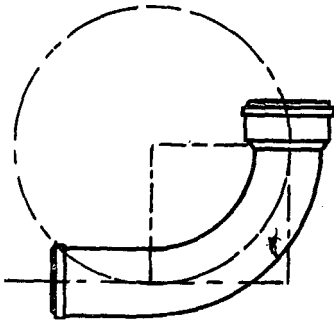

(37) Showing method of determining radius of bends. H 62.15 (5) (f), H 62.15 (12).

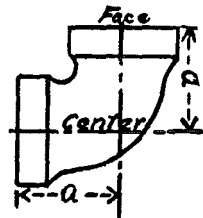

(38) Showing method of determining radius of screw thread drainage fittings. H 62.15 (8), (12).

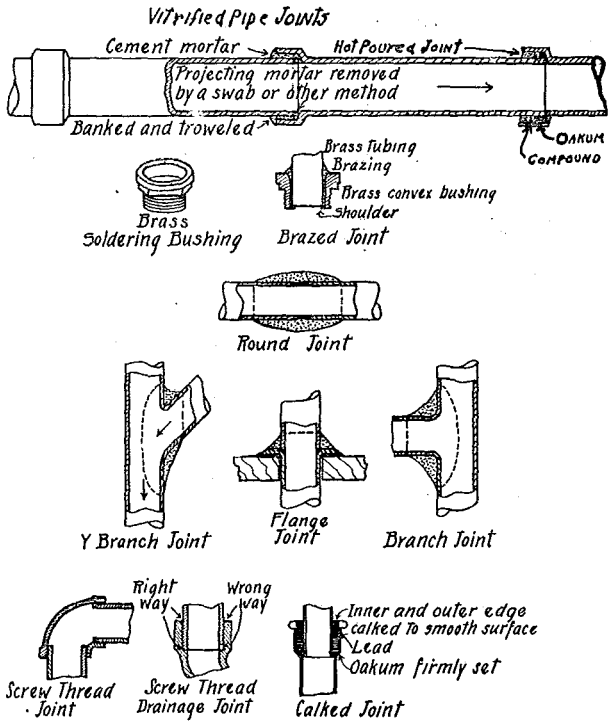

(39) Showing methods of making joints in vitrified clay pipe, cast iron soil pipe, screw thread pipe, wiped joints in lead pipe, and brazed joints in connection with traps. H 62.16 (1).

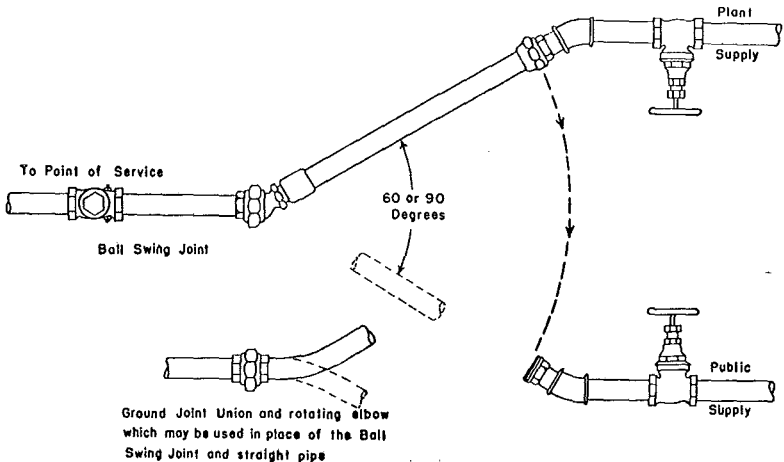

(40) Approved type of service connection with secondary water supplies. H 62.19 (7).

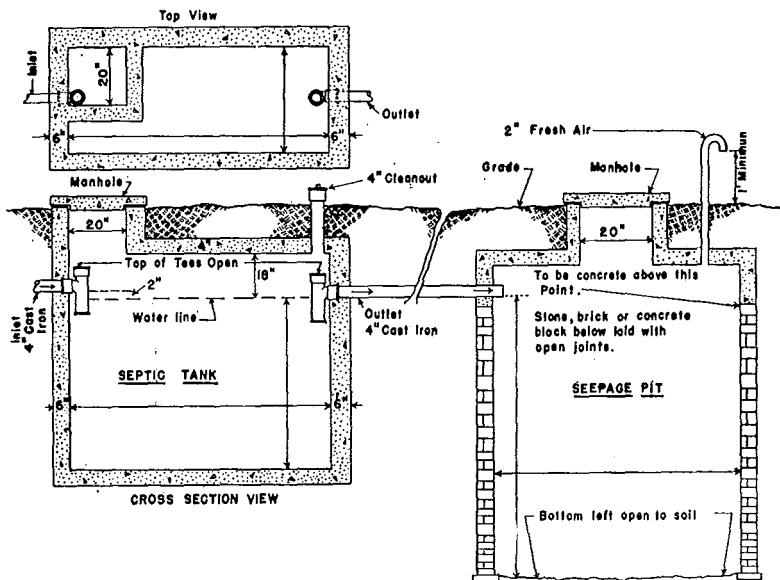

(41) Illustrating a minimum size septic tank and seepage pit. H 62.20 (1) (e), (2) (b), (3).

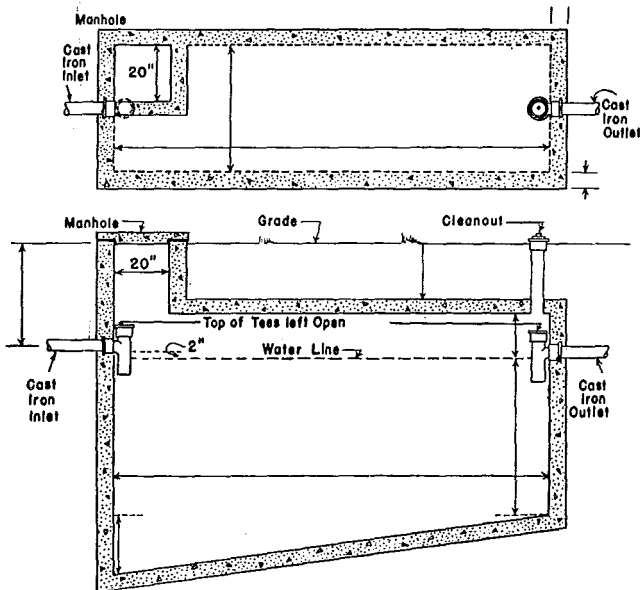

(42) Illustrating a large size septic tank with hopper bottom. H 62.20 (1) (e).

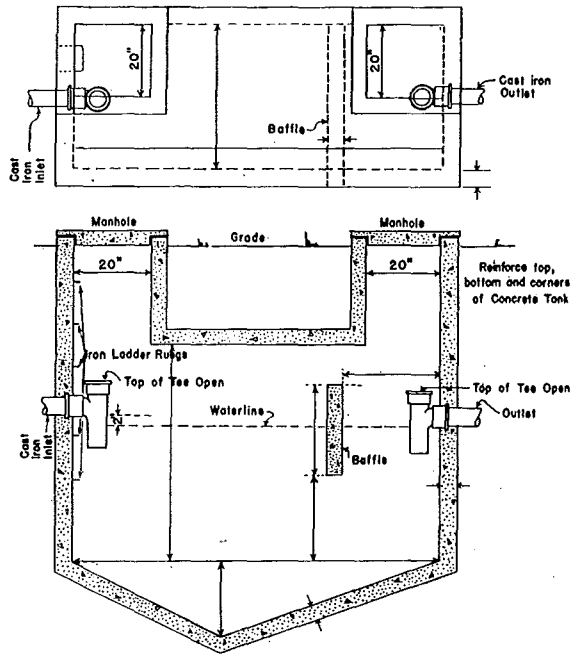

CROSS SECTION OF SEPTIC TANK

(43) Illustrating a large septic tank with hopper bottom and baffle. H 62.20 (1) (e).

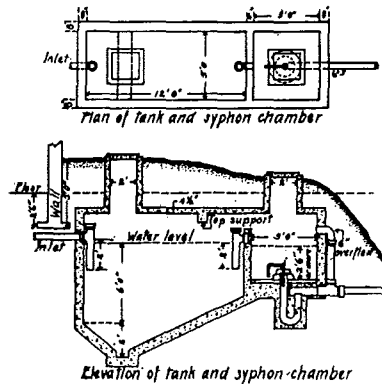

Elevation of tank and syphon-chamber

(44) Showing a septic tank equipped with automatic siphon. H 62.20 (2) (c).

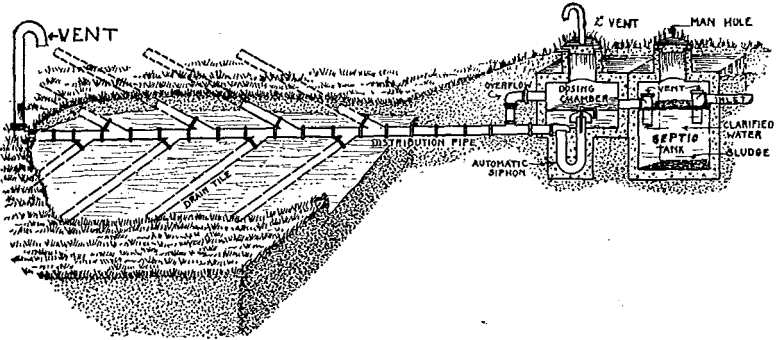

(45) Illustrating sewage, disposal system consisting of septic tank, dosing chamber, siphon and drainage tile. H 62.20 (2) (c), (3).

**H 62.23 Industrial commission regulations.** The regulations of the industrial commission of Wisconsin pertaining to plumbing, toilet rooms, and sanitation of public buildings shall be followed wherever they are applicable.

Order IND. 4.420.

Orders IND. 17.2200 to IND. 17.2217, inclusive.

Orders IND. 23.5250 to IND. 23.5264, inclusive.

Orders IND. 23.5400 and IND. 23.5412.

Orders IND. 23.5500, IND. 23.5501, IND. 23.5532, IND. 23.5567, and IND. 23.5568 (7).

Orders IND. 23.5600, IND. 23.5611, IND. 23.5612, and IND. 23.5616.

Orders IND. 23.5700, IND. 23.5713, IND. 23.5714, IND. 23.5715 and IND. 23.5716.

Order IND. 24.5848.