

Chapter Comm 82

APPENDIX

The material contained in this appendix is for clarification purposes only. The notes, illustrations, etc., are numbered to correspond to the number of the rule as it appears in the text of the code.

A-82.11 (29) BRANCH INTERVALS.

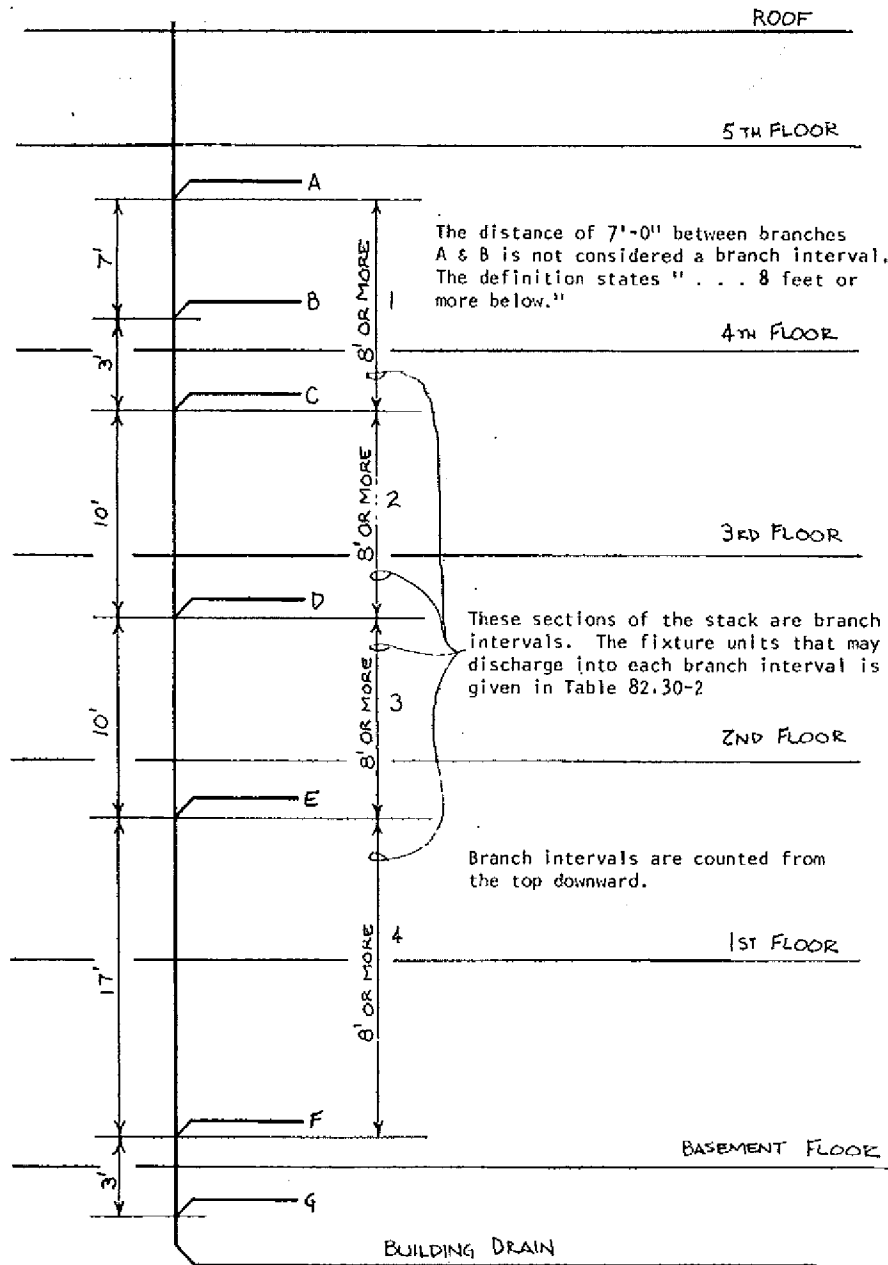

A-82.11 (140) SPRINGLINE OF PIPE

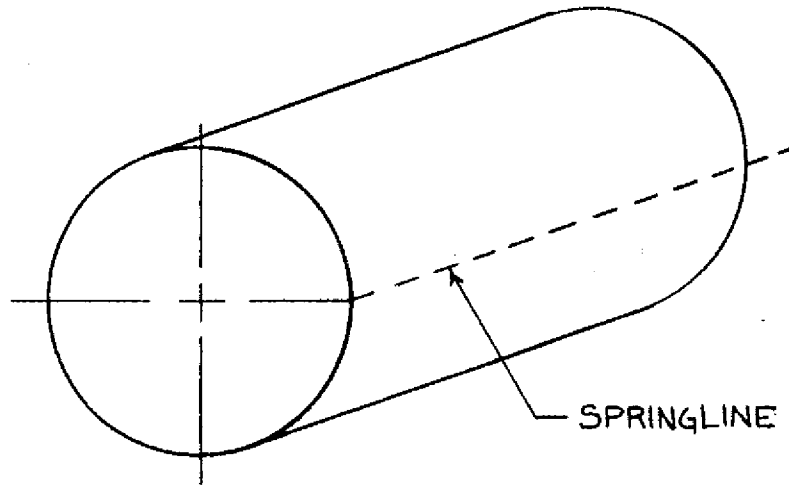

On a round pipe the springline is along the horizontal centerline.

A-82.20 (2) AGENT MUNICIPALITIES. The department has designated to the following municipalities, the authority to review and approve plumbing plans and specifications for those plumbing installations to be located within the municipality's boundary limits and which require approval under s. Comm 82.20 (1) (b).

Appleton
100 N. Appleton Street
Appleton, WI 54911-4799
(414) 832-6411

Eau Claire
203 South Farwell Street,
Eau Claire, WI 54701
(715) 839-4947

Green Bay
100 N. Jefferson St., Rm. 403
Green Bay, WI 54301
(414) 448-3295

Greenfield
7325 W. Forest Home Ave.
Greenfield, WI 53220
(414) 543-5500

Janesville
P. O. Box 5005
Janesville, WI 53547-5005
(608) 755-3064

Kenosha
Dept. of Housing
625 52nd St., Rm. 100
Kenosha, WI 53140
(414) 658-4263

Madison
P. O. Box 2984
Madison, WI 53701-2984
(608) 266-4568

Milwaukee
Municipal Bldg., Rm. 1017
841 N. Broadway Street
Milwaukee, WI 53202
(414) 286-3364

Oshkosh
215 Church Ave.
Oshkosh, WI 54901
(414) 236-5052

Racine
730 Washington Ave.
Racine, WI 53403
(414) 636-9164

Sheboygan
City Hall - 3rd Floor
828 Center Ave.
Sheboygan, WI 53081
(414) 459-3479

Two Rivers
P. O. Box 87
Two Rivers, WI 54241
(414) 793-5580

A-82.20 (4) PLANS AND SPECIFICATIONS. The following is a list of water quality management agencies and the areas they serve.

<u>AGENCY</u>	<u>AREAS SERVED</u>
East Central Wisconsin Regional Planning Commission 132 Main Street Menasha, WI 54952 (414) 751-4770	Counties of Menominee, Shawano, Waupaca, Outagamie, Waushara, Marquette, Green Lake, Winnebago, Calumet, Fond du Lac
Dane County Regional Planning Commission 217 South Hamilton, Room 403 Madison, WI 53703 (608) 266-4137	County of Dane
Brown County Planning Commission 100 N. Jefferson Street, Room 608 Green Bay, WI 54301 (414) 448-3400	County of Brown
Southeastern Wisconsin Regional Planning Commission 916 North East Avenue P. O. Box 1607 Waukesha, WI 53187-1607 (414) 547-6721	Counties of Washington, Ozaukee, Waukesha, Milwaukee, Walworth, Racine, Kenosha
West Central Wisconsin Regional Planning Commission 800 Wisconsin Street, Mailbox 9 Eau Claire, WI 54703-3606 (715) 836-2918	Cities of Eau Claire, Altoona, Chippewa Falls Towns of Hallie, Seymour, Union, Washington
St. Croix County Planning Office 1101 Carmichael Road Hudson, WI 54016 (715) 286-4673	City of Hudson Towns of Hudson, St. Joseph, Troy Village of North Hudson
Bay-Lake Regional Planning Commission 211 N. Broadway, Suite 211 Green Bay, WI 54303 (414) 448-2820	Cities of Marinette, Kohler, Sheboygan, Sheboygan Falls, Sturgeon Bay Towns of Peshtigo, Porterfield, Mosel, Wilson, Lima, Herman, Sheboygan, Sheboygan Falls

AGENCY (continued)

Rock County Planning Agency
51 South Main Street
Janesville, WI 53545
(608) 757-5587

Office of City Engineer
400 LaCrosse Street
LaCrosse, WI 54601
(608) 789-7505

Portage County Planning Department
1516 Church Street
Stevens Point, WI 54481
(715) 346-1334

Marathon County Planning Department
210 River Drive
Wausau, WI 54403
(715) 847-5227

Wood County Planning
400 Market Street
Wisconsin Rapids, WI 54495
(715) 421-8466

Dunn County Land Conservation
390 Red Cedar Street
Menomonie, WI 54751
(715) 232-1520

AREAS SERVED

Cities of Janesville, Beloit, Edgerton, Evansville, Milton
Towns of Beloit, Harmony, Rock, Janesville, LaPrairie, Turtle

Cities of LaCrosse, Onalaska
Towns of Onalaska, Shelby, Medary, Campbell

City of Stevens Point
Towns of Hull, Plover, Linwood
Villages of Whiting, Plover, Park Ridge

Cities of Wausau, Schofield
Towns of Weston, Stettin, Rib Mountain, Kronenwetter
Village of Rothschild

City of Wisconsin Rapids
Towns of Grand Rapids, Rudolph, Sigel, Seneca, Grant
Village of Biron

City of Menomonie

A-82.30 (4) SIZE OF DRAIN PIPING. The following tables list the maximum GPM which can be expected to readily flow through a given size trap where the receptor has a height as indicated.

Also listed is a maximum drainage fixture unit load which a given size receptor trap may be expected to adequately receive.

Note: The department recommends an individual 4-inch diameter minimum trap and drain pipe for a commercial type dishwasher.

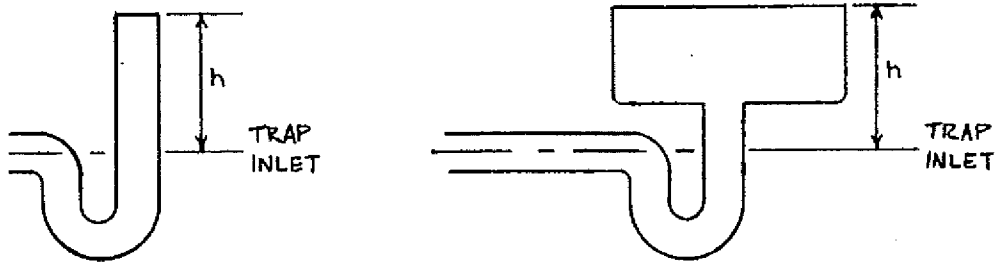

Receptor Trap Size	H - Height	GPM	d.f.u.
1-1/2"	12"	4	2
2"	14"	8	4
3"	15"	12	6
4"	17"	40	20
5"	20"	70	35
6"	22"	120	60
8"	25"	250	125

A-82.30 (6) (b) OFFSETS IN VERTICAL DRAINS.

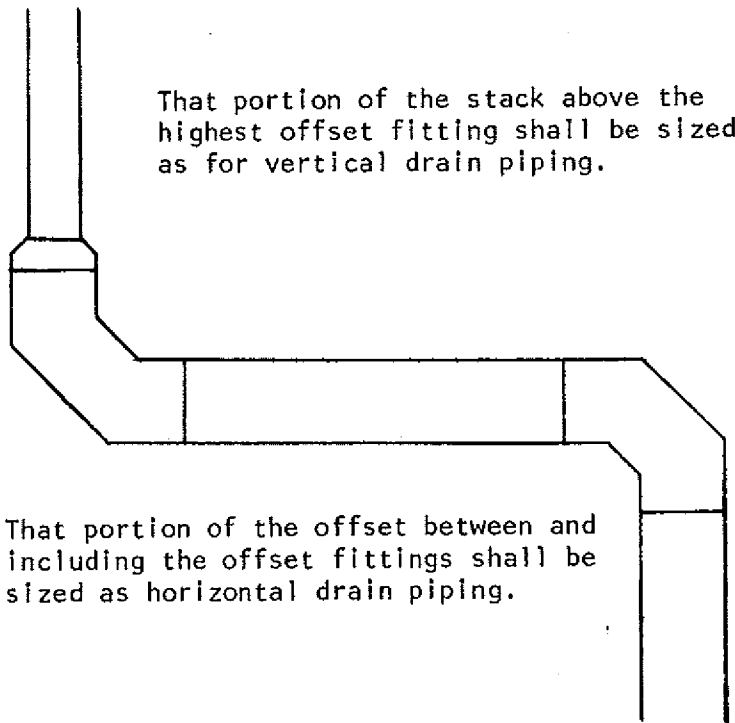

That portion of stack below the offset shall be not less than the size of the offset and not less than the size required for vertical drain piping.

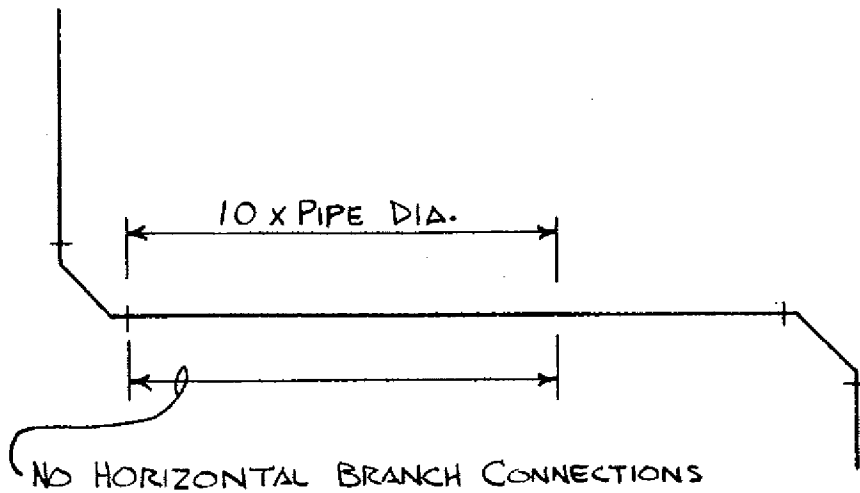

A-82.30 (7) HORIZONTAL BRANCH DRAIN CONNECTION AT BASE OF A STACK.

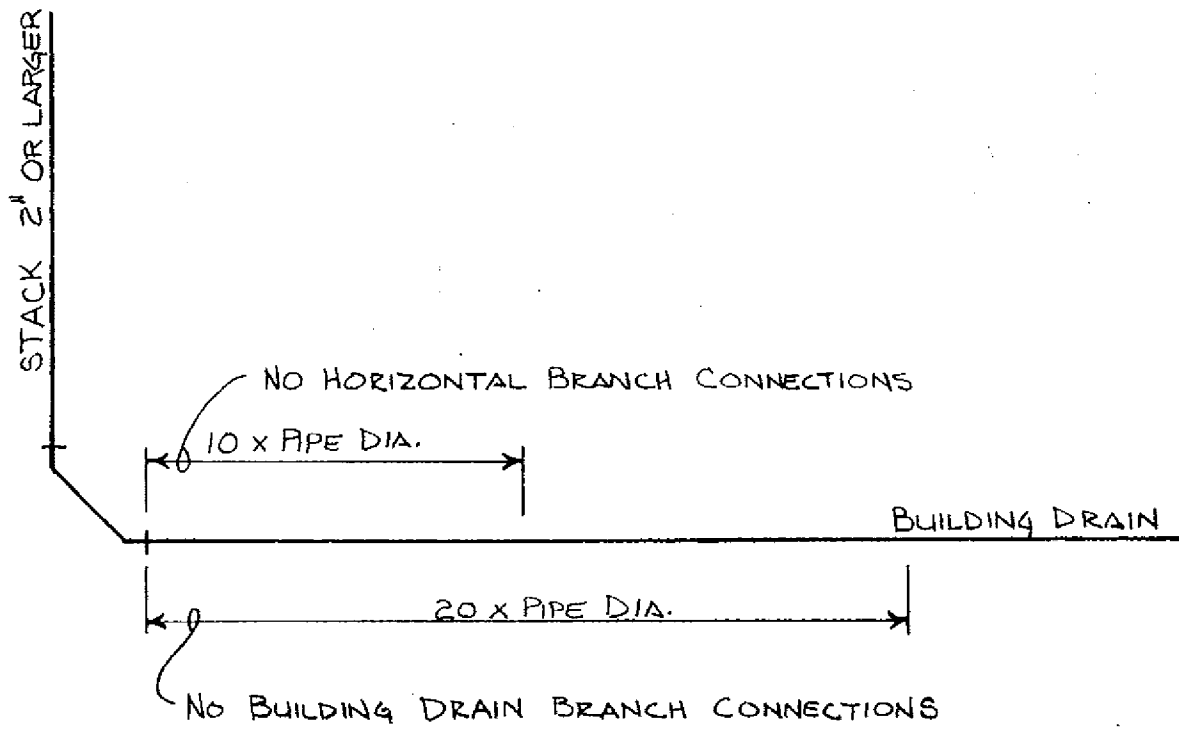

A-82.30 (8) MEASURING RADIUS OF A FITTING.

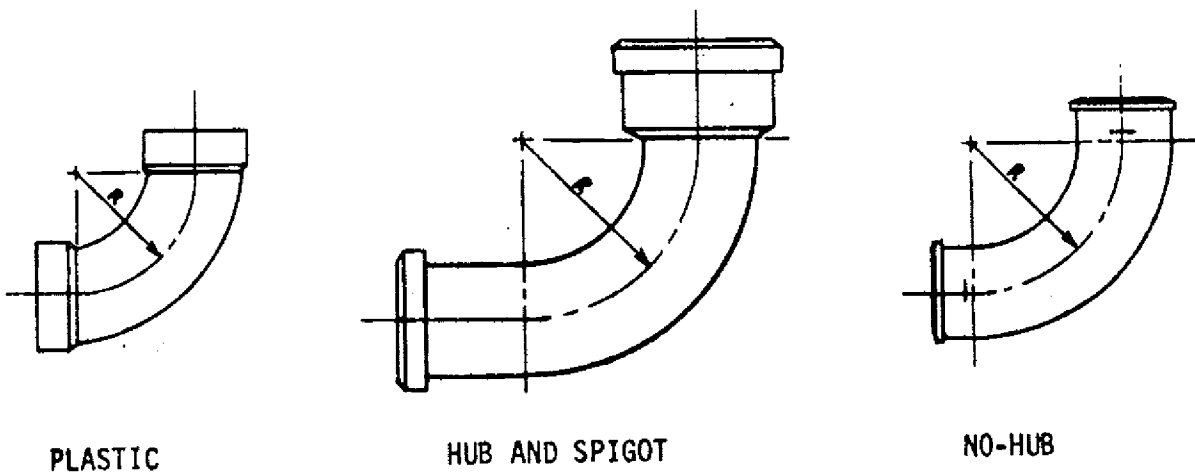

A-82.30 (9) DRAIN FITTINGS AND CONNECTIONS.

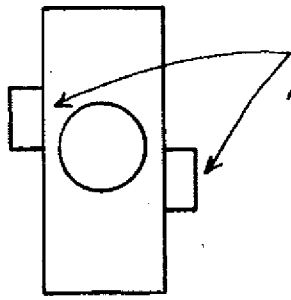

SIDE VIEW

SHALL NOT BE USED
AS A VENT CONNECTION

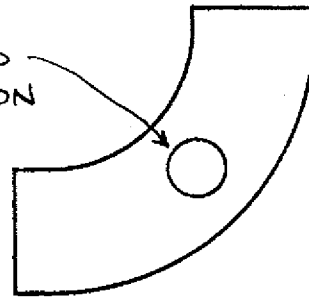

SIDE VIEW

SIDE INLETS

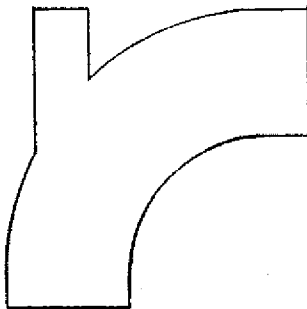

ALLOWED
(SIDE VIEW)

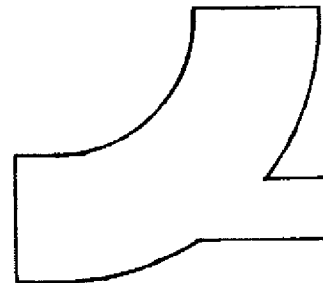

NOT ALLOWED
(TOP VIEW OR SIDE VIEW)

HEEL INLETS

A-82.30 (10) (a) DETERMINING REQUIRED CAPACITY OF SANITARY PUMP.

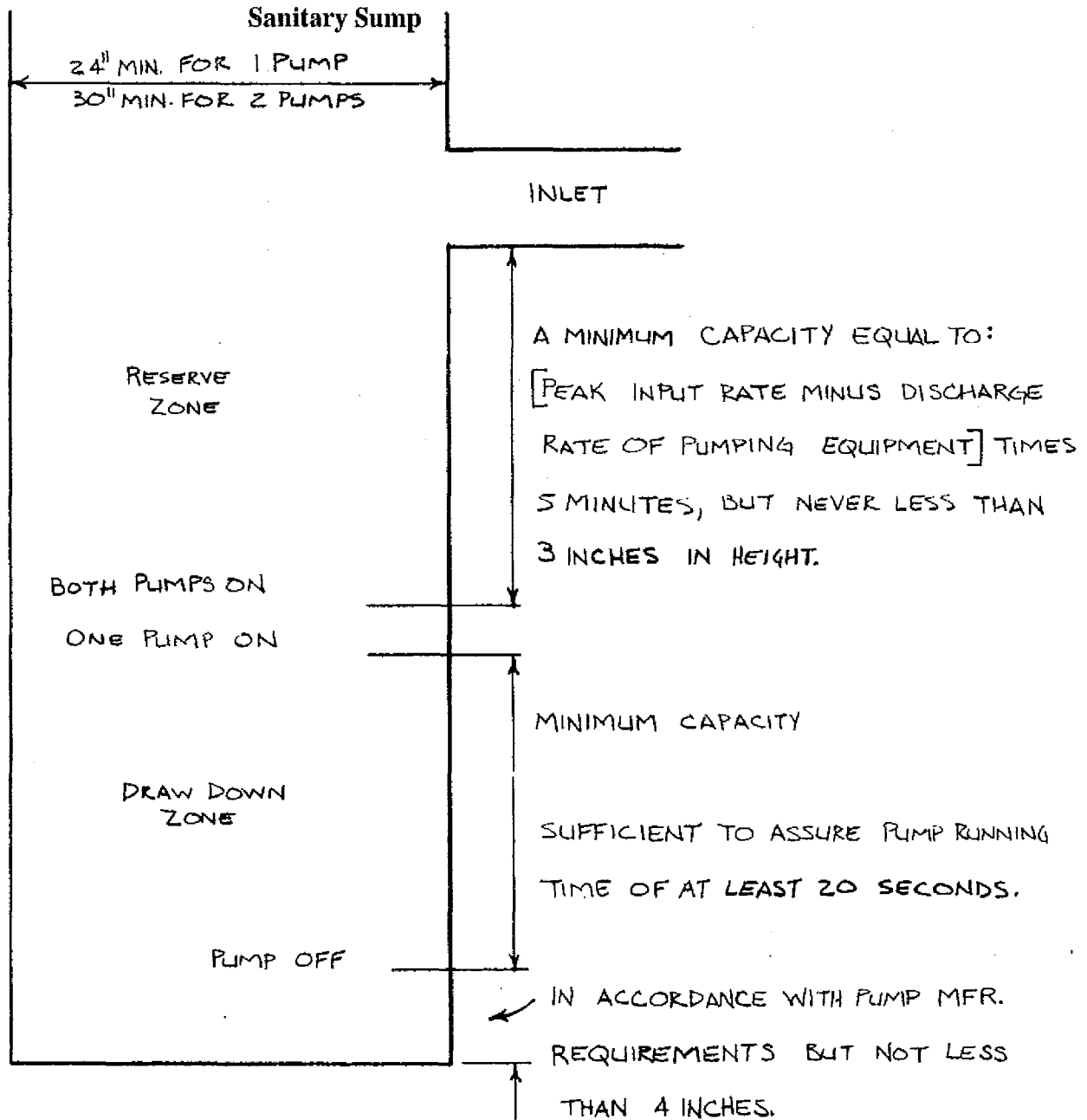

A-82.30 (10) (a) SUMPS.

Capacity of sumps
(in gallons)

Diameter of sump in inches	Volume in gal/ft	Diameter of sump in inches	Volume in gal/ft
24	23.5	41	68.6
25	25.5	42	72.1
26	27.6	43	75.5
27	29.7	44	79.1
28	32.0	45	82.7
29	34.3	46	86.5
30	36.8	47	90.2
31	39.2	48	94.0
32	41.8	54	119.0
33	44.5	60	147.0
34	47.2	66	178.0
35	50.0	72	211.5
36	52.8	78	248.4
37	55.9	84	288.1
38	59.0	90	330.8
39	62.1	96	376.3
40	65.3	108	477.3

A-82.30 (11) (b) BUILDING DRAINS SERVING ANY BUILDING.

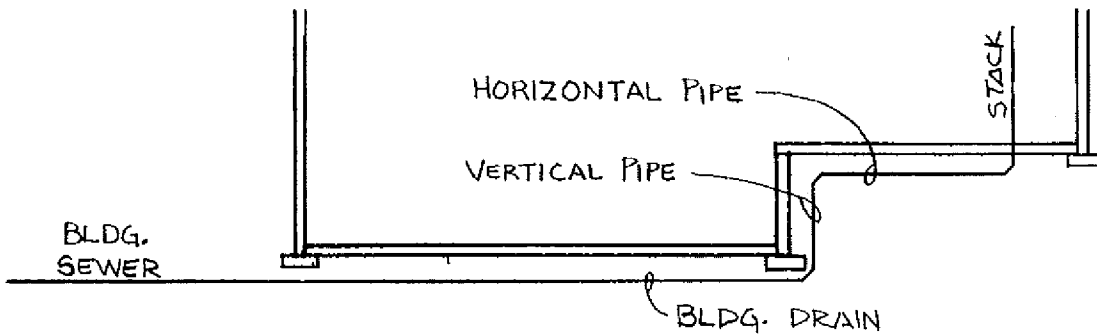
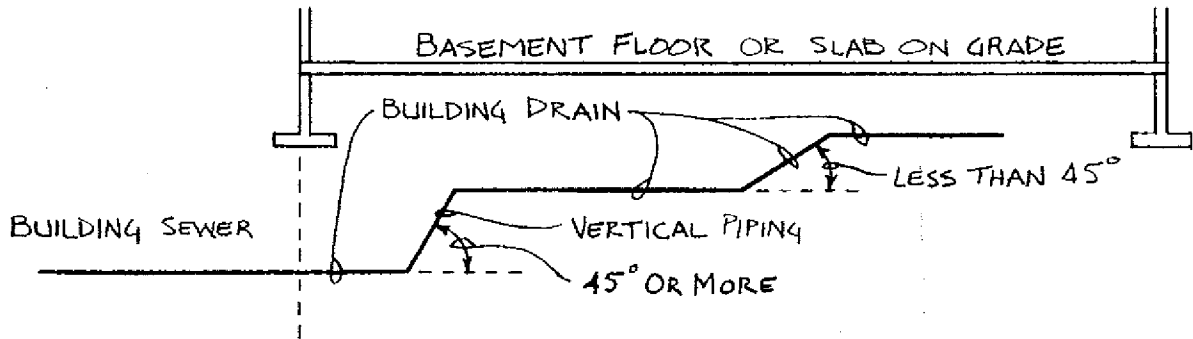

A-82.30 (11) (b) BUILDING DRAINS.

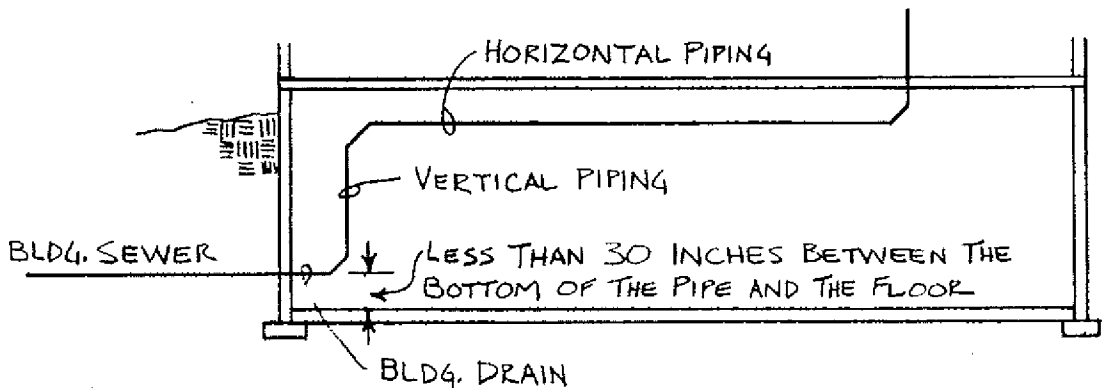
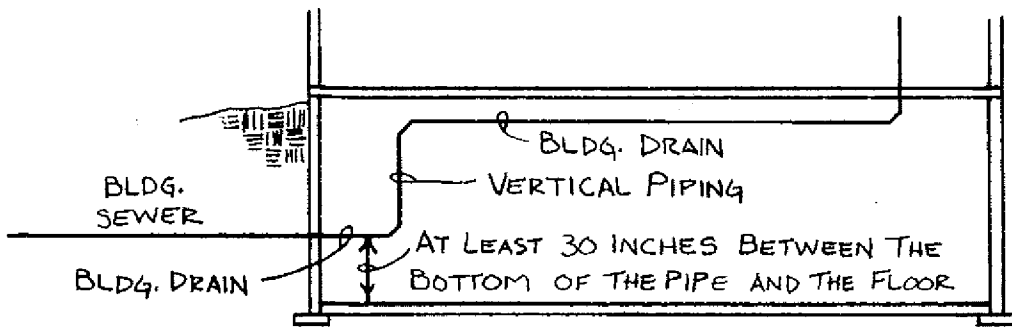

A-82.30 (11) (b) FLOOR DRAIN REQUIRED.

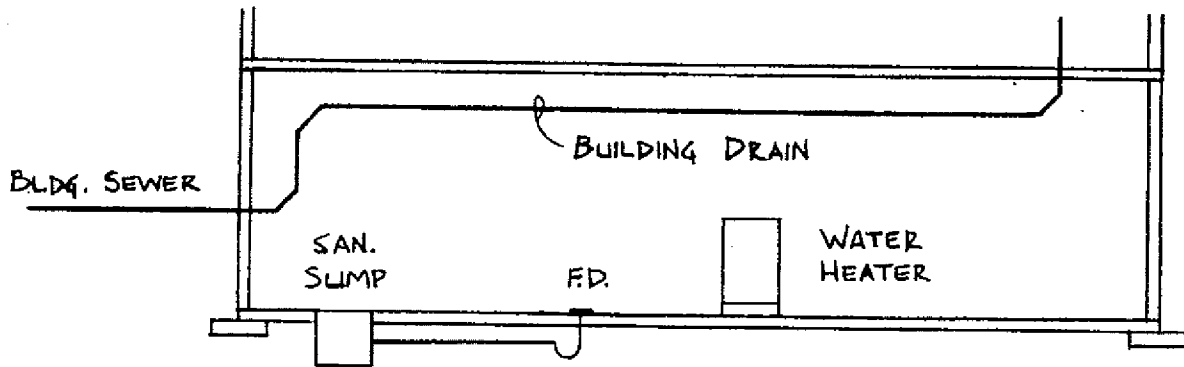

A-82.30 (11) (f) CONNECTION TO PRESSURIZED PUBLIC SEWER.

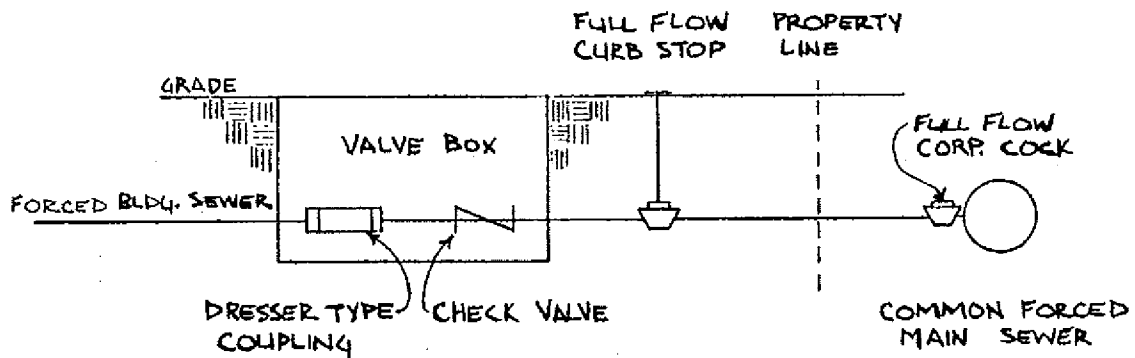

A-82.31 (4) (a) WHERE A VENT STACK AND STACK VENT ARE REQUIRED.

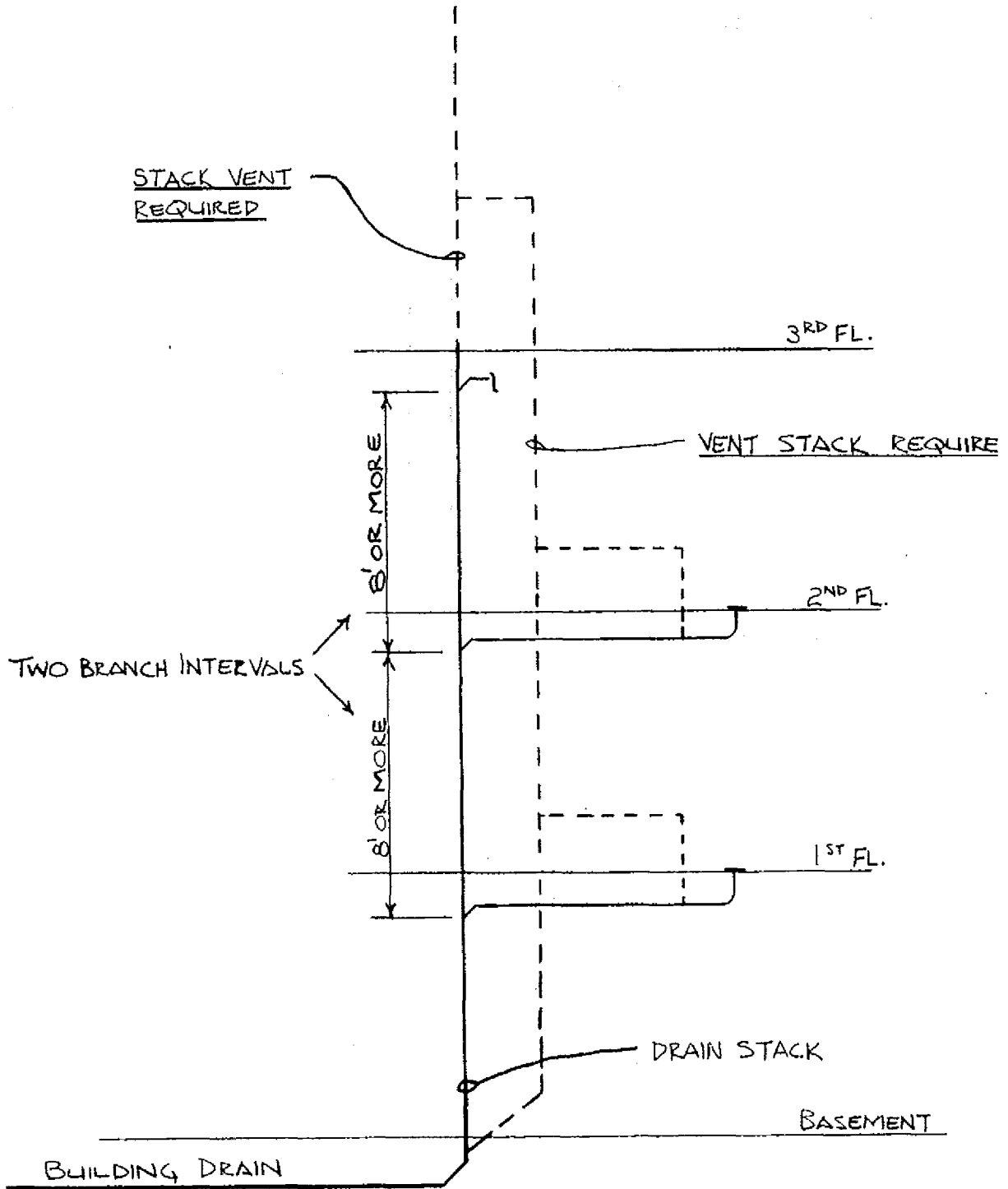

A-82.31 (4) (a) WHERE A VENT STACK AND STACK VENT ARE NOT REQUIRED.

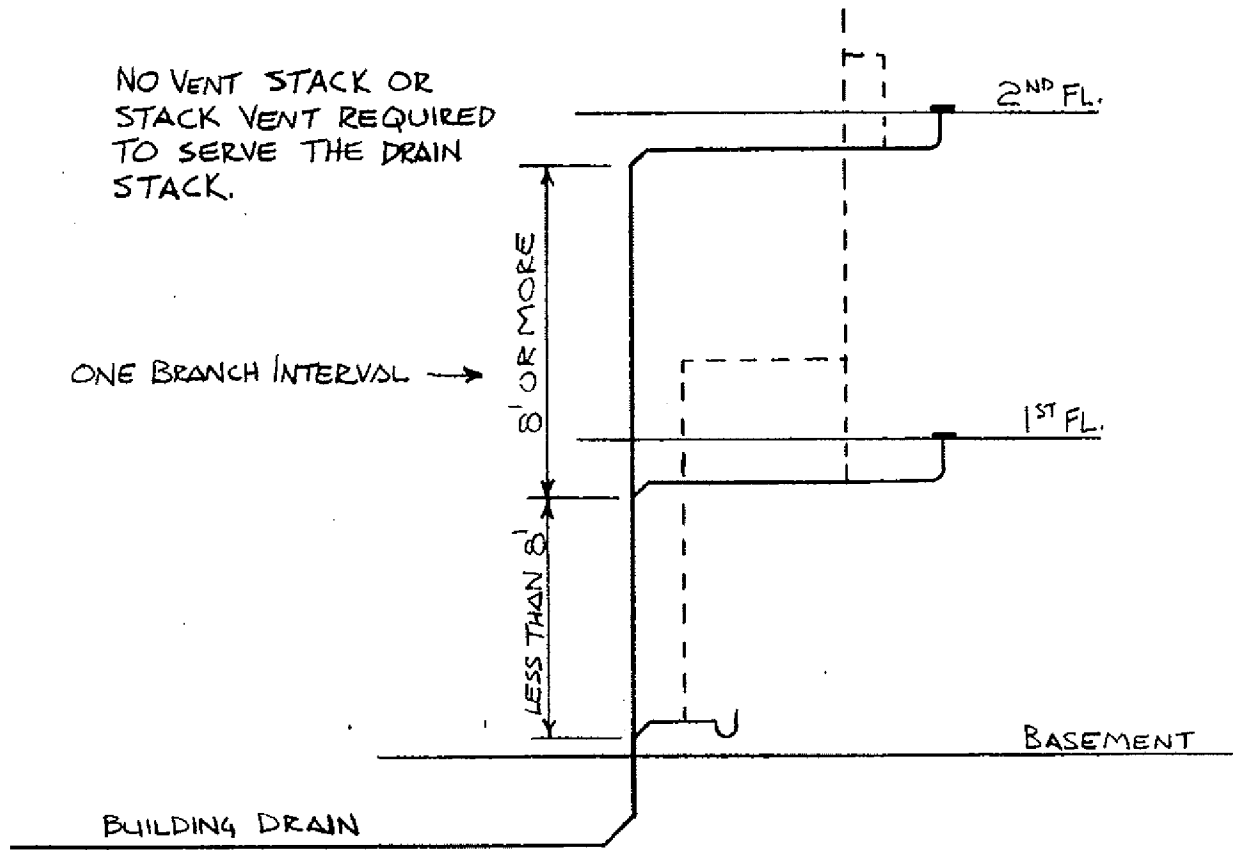

A-82.31 (4) (b) INSTALLATION OF VENT STACK AND STACK VENT.

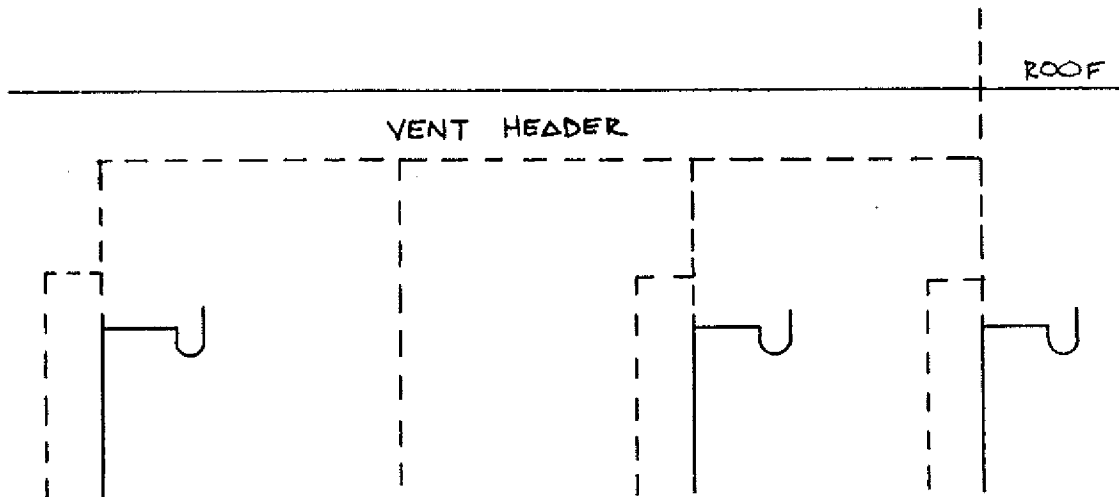
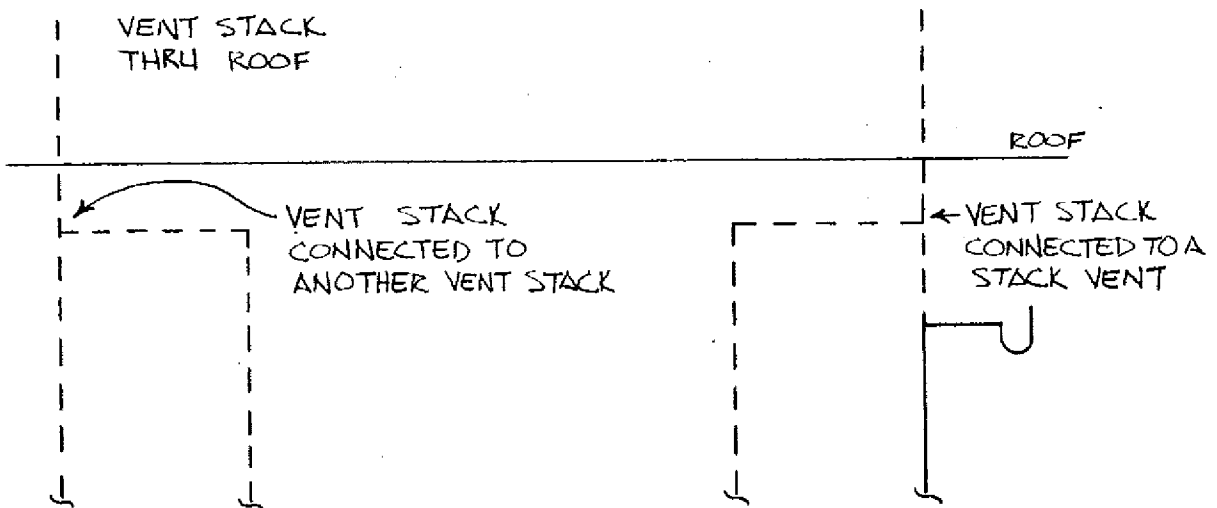
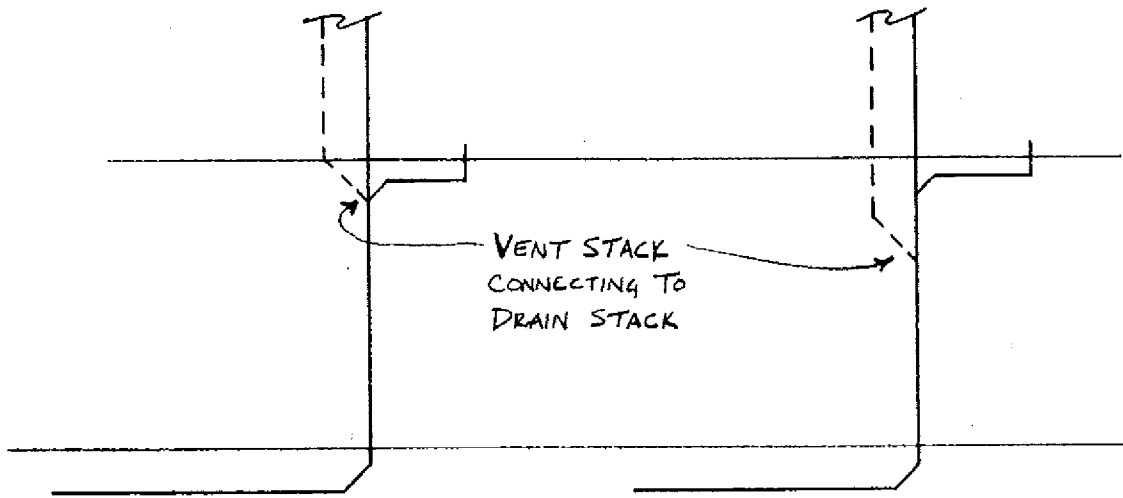

A-82.31 (5) (a) Relief vent for offsets of 30 to 45 degrees.

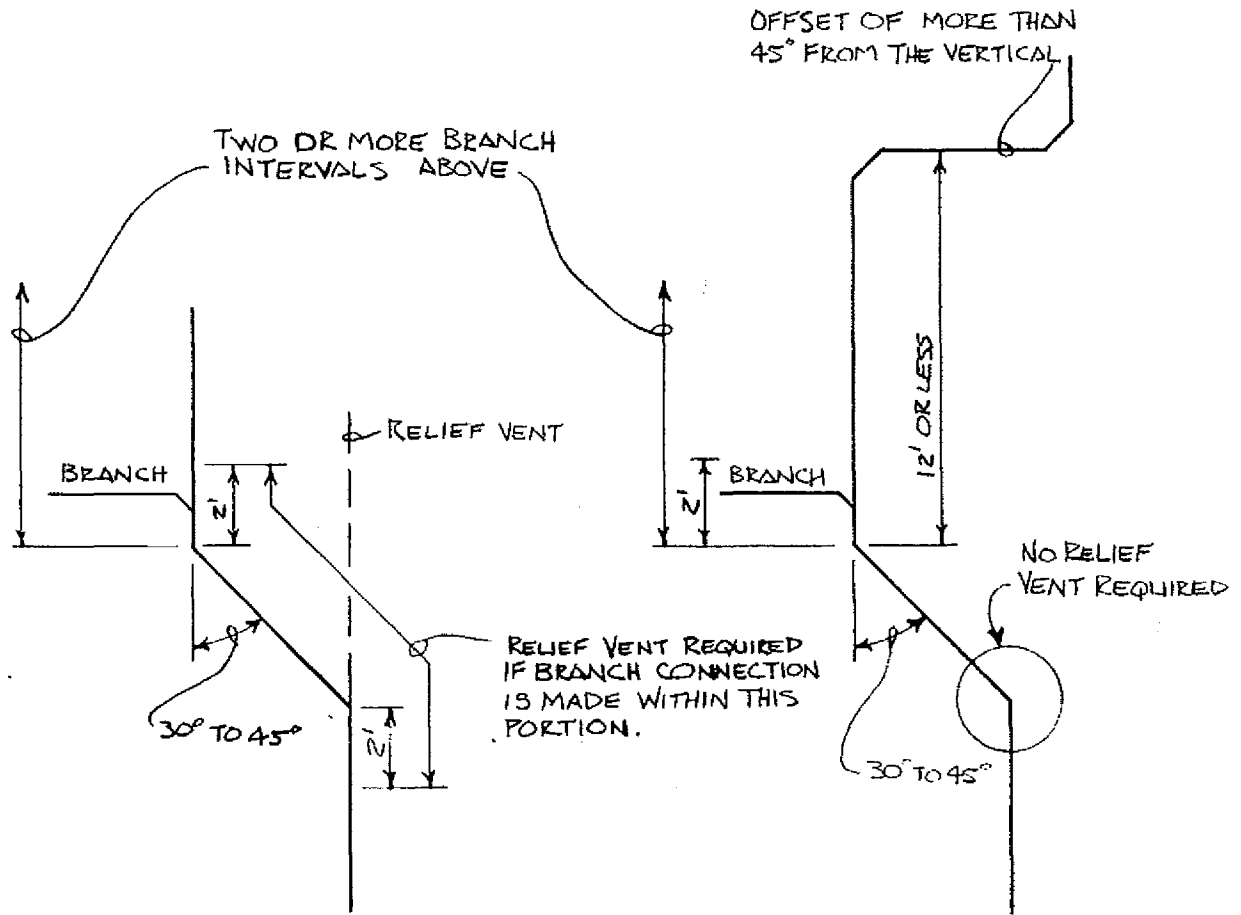

A-82.31 (5) (b) RELIEF AND YOKE VENTS FOR OFFSETS OF MORE THAN 45 DEGREES.

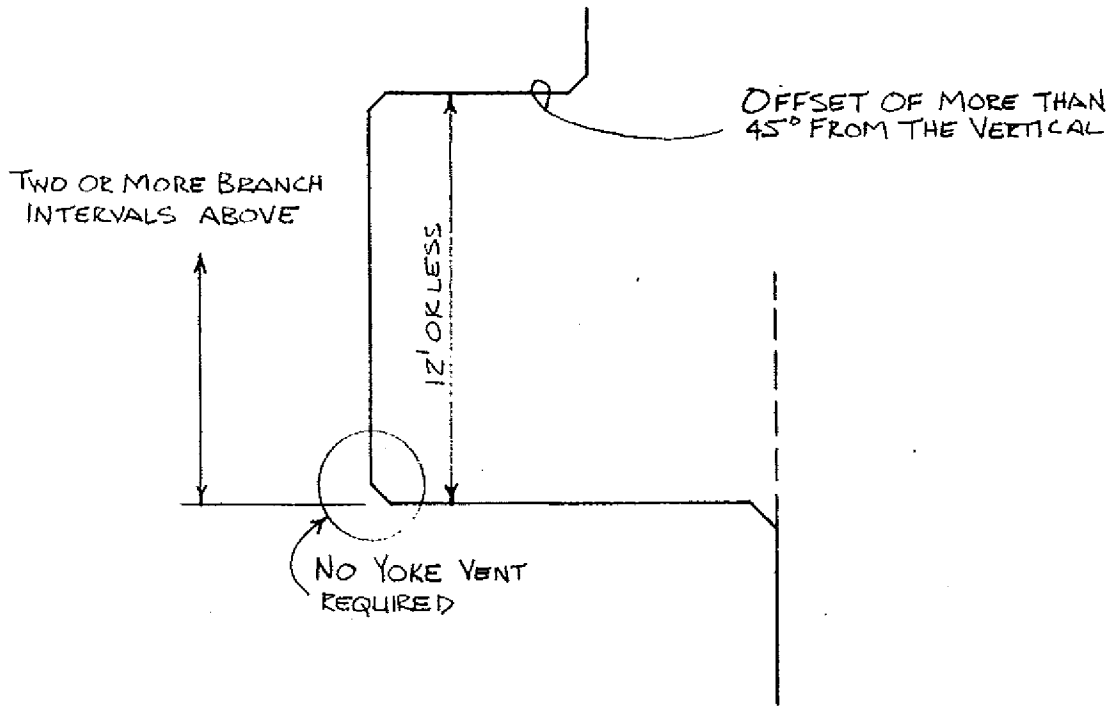
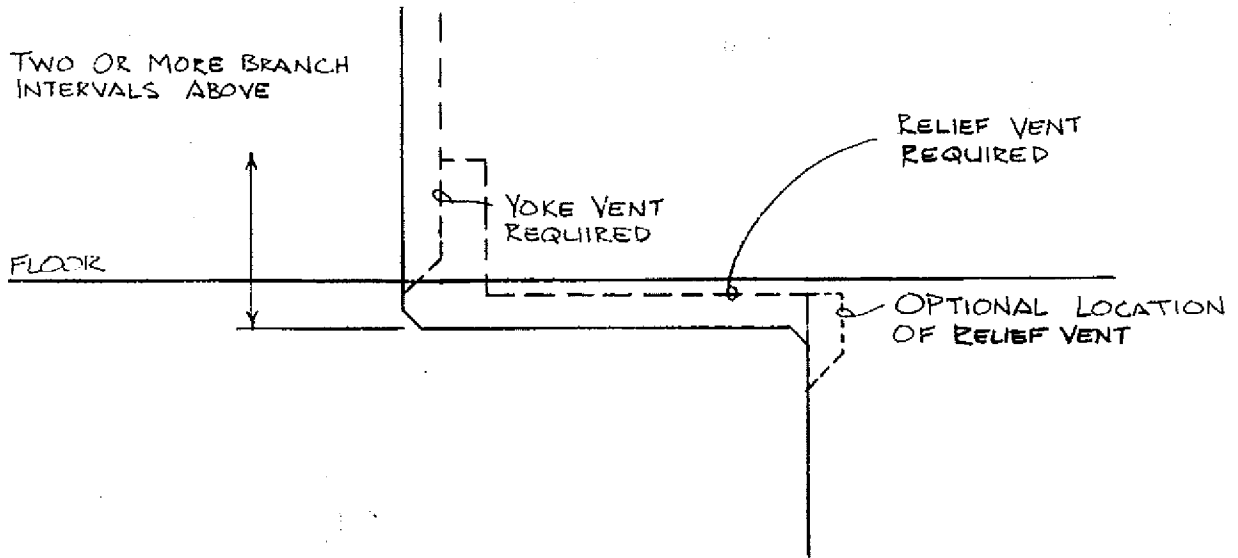

A-82.31 (7) RELIEF VENTS FOR BUILDING DRAINS.

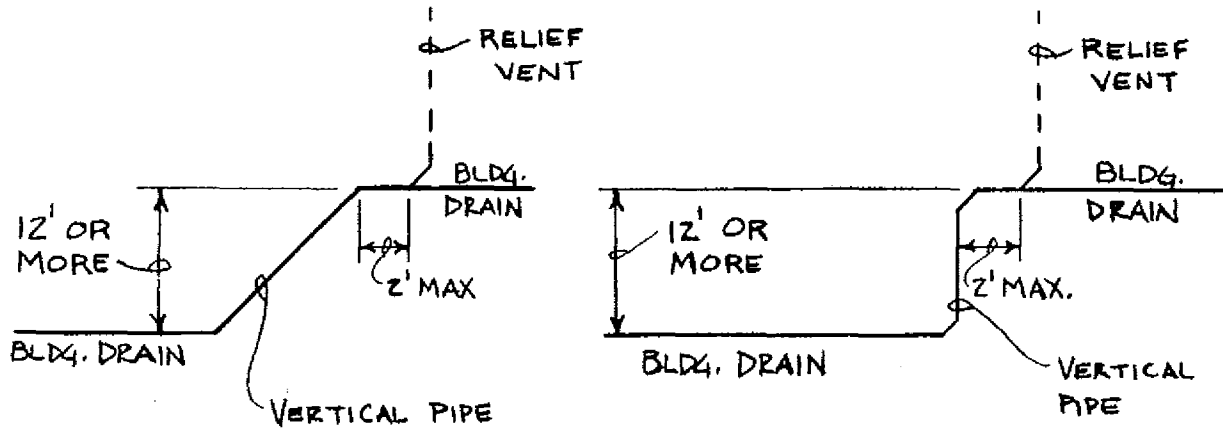

A-82.31 (9) FIXTURE VENTS.

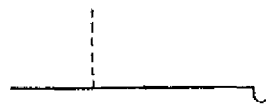
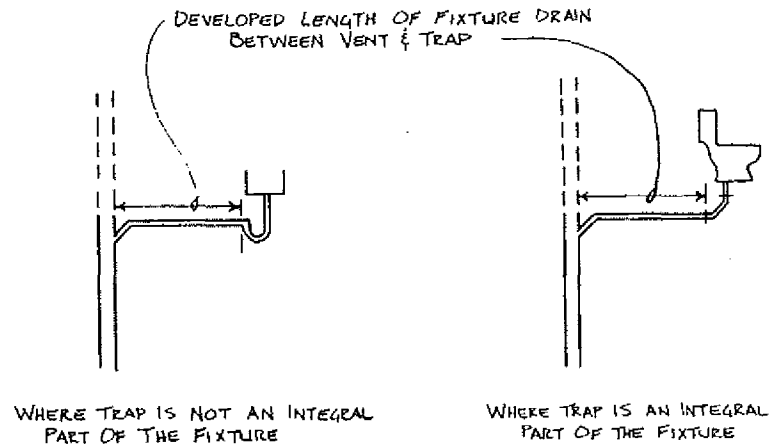

VENT CONNECTING TO HORIZONTAL DRAIN PIPING

VENT CONNECTING TO VERTICAL DRAIN PIPING

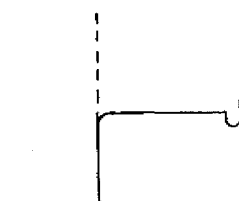

BY MEANS OF A SANITARY TEE FITTING

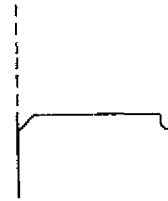

BY MEANS OF A WYE PATTERN FITTING

A-82.31 (10) CIRCUIT VENTING.

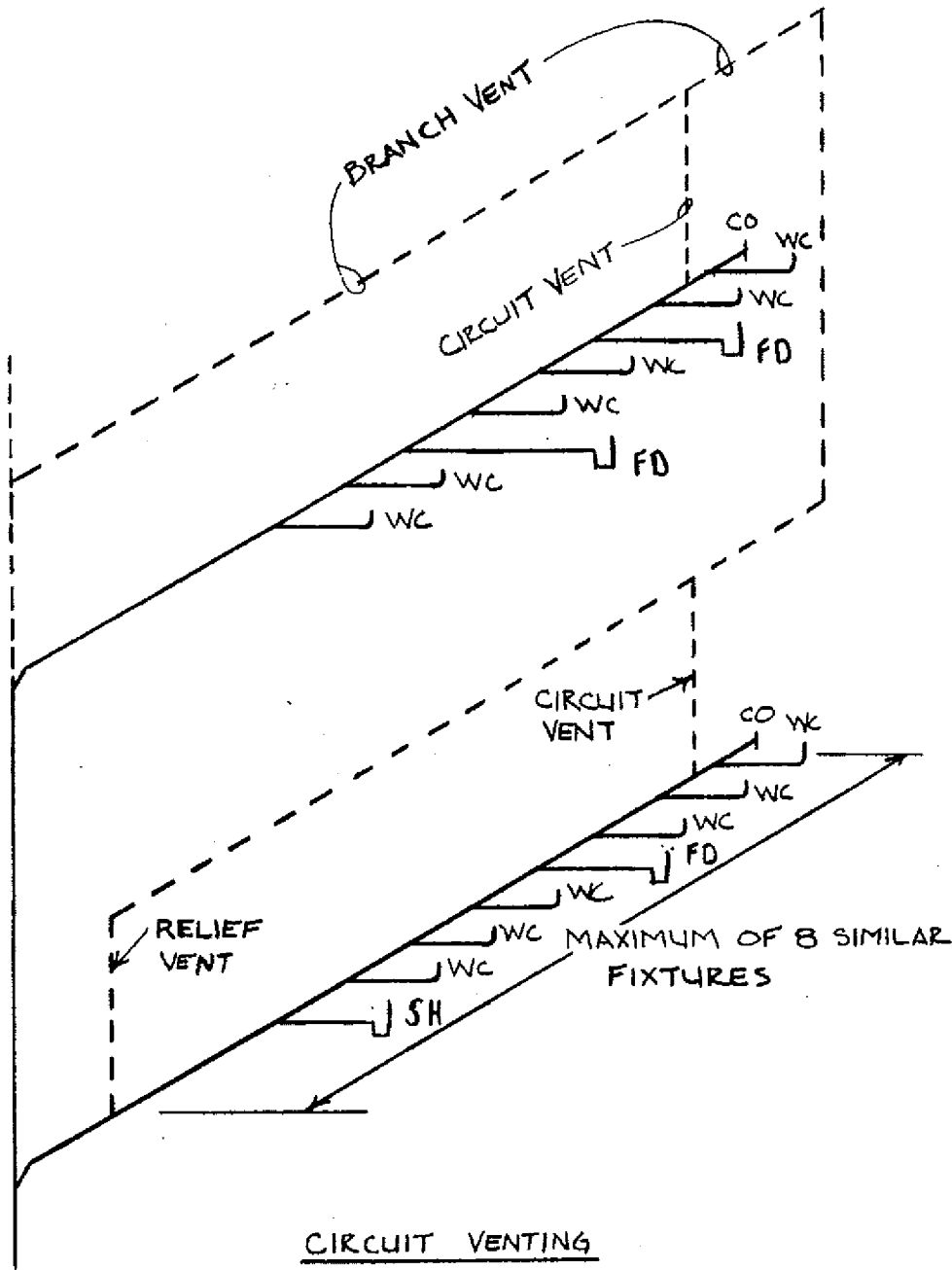

A-82.31 (10) CIRCUIT VENTING.

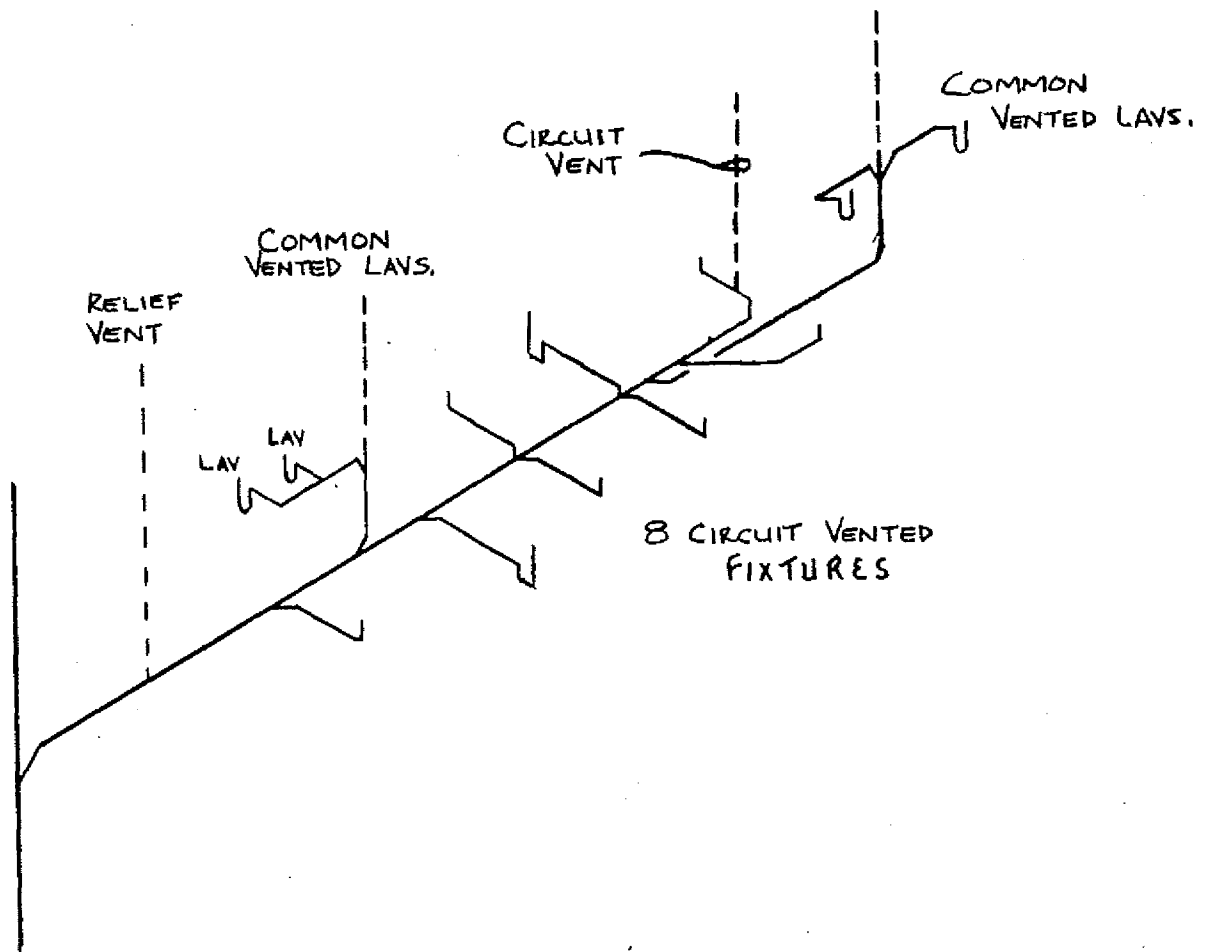

A-82.31 (10) CIRCUIT VENTING.

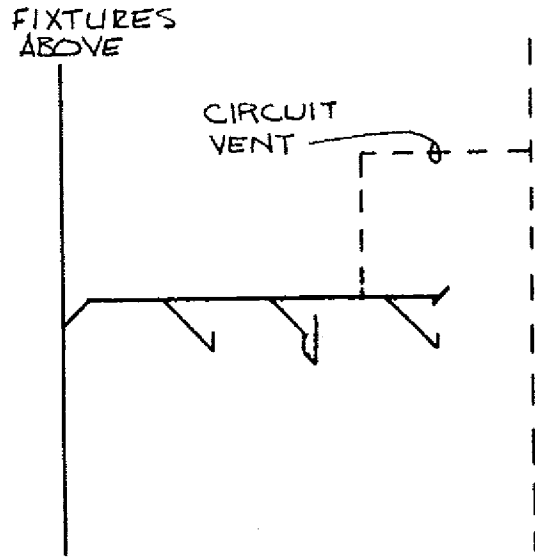
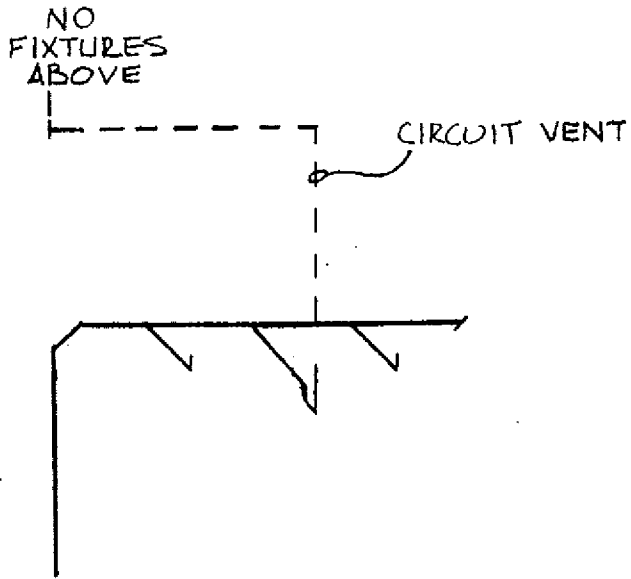

CIRCUIT VENTING
3 FIXTURES

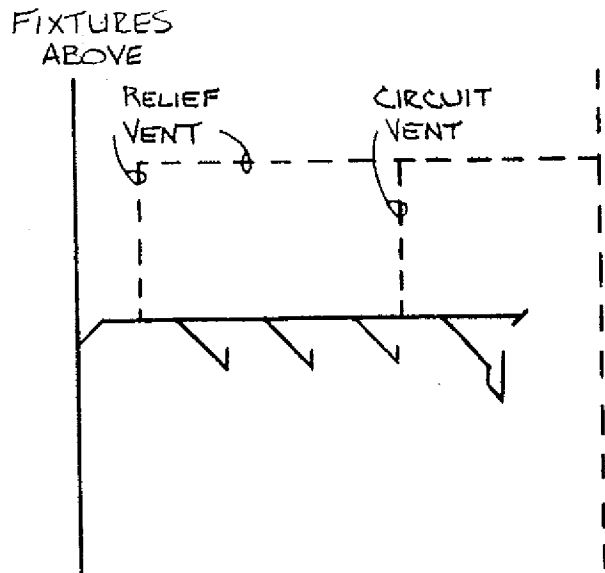
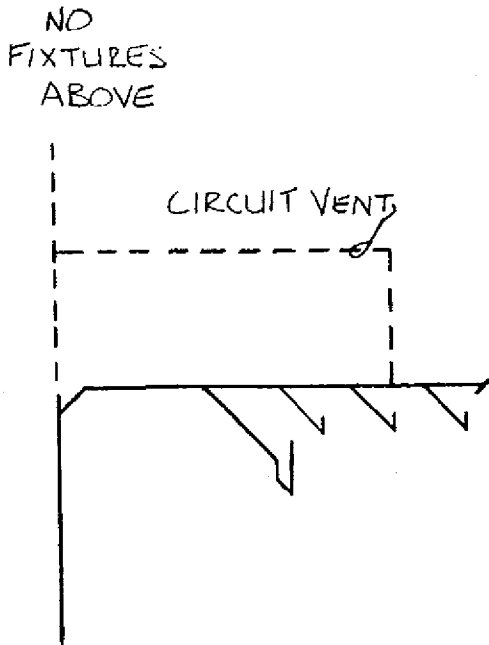

CIRCUIT VENTING 4 OR
MORE FIXTURES

A-82.31 (10) CIRCUIT VENTING.

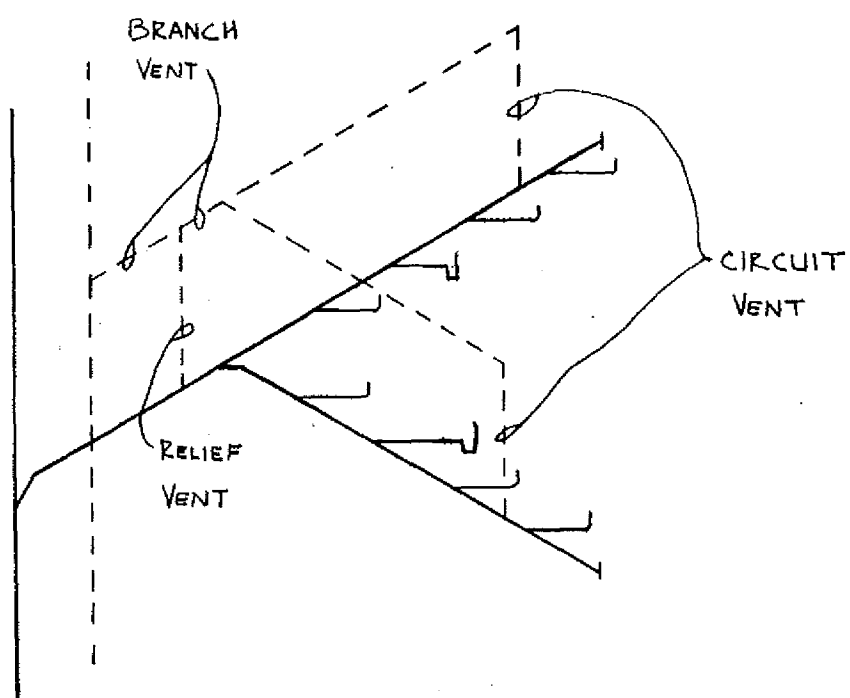
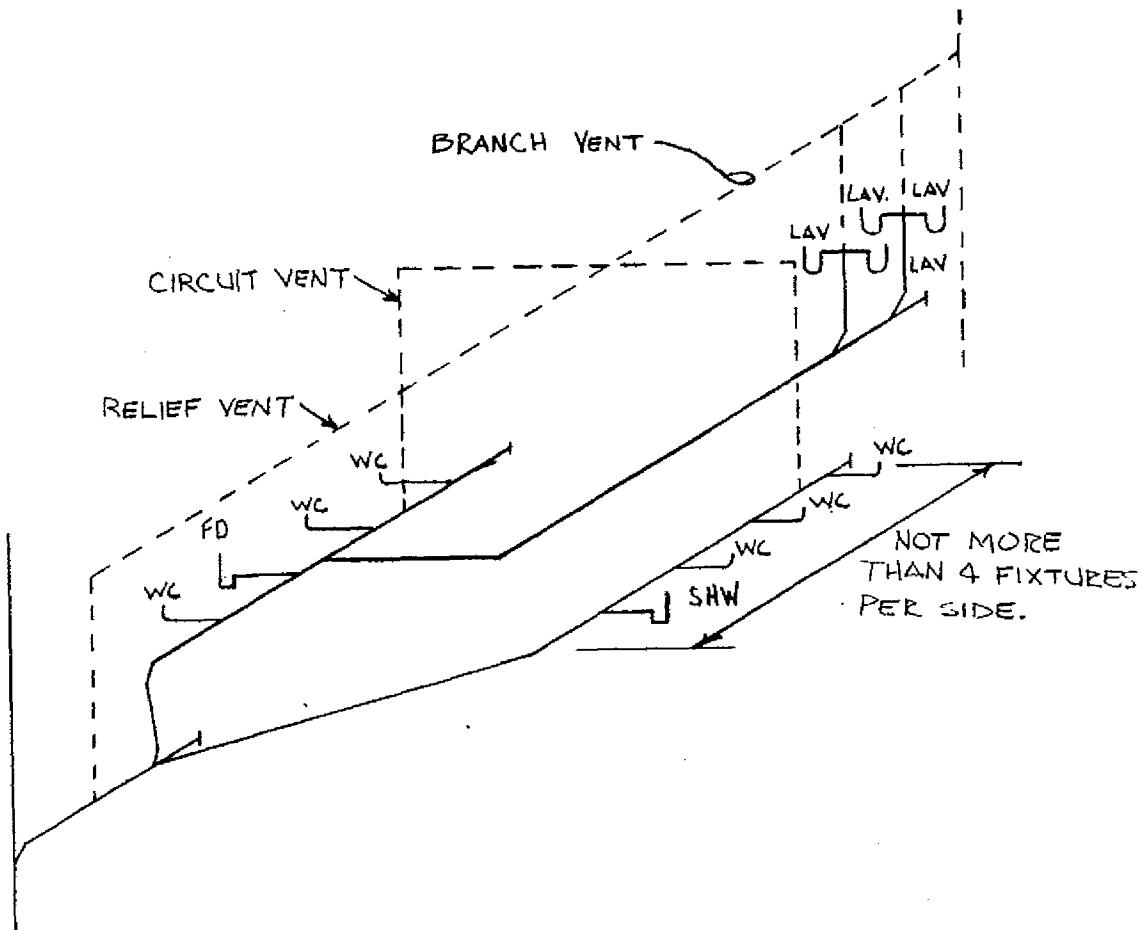

A-82.31 (11) (a) COMMON VENTS, VERTICAL DRAINS.

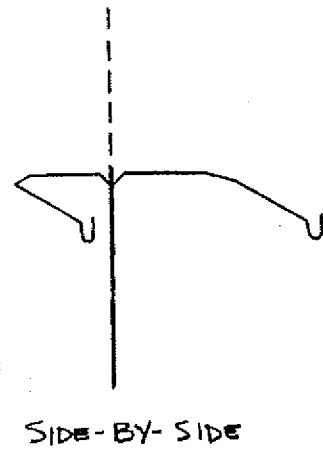
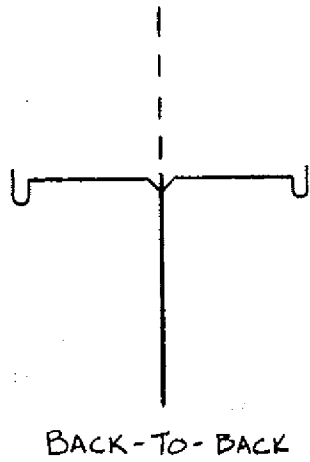

COMMON VENT SERVING ANY TWO FIXTURES

A-82.31 (11) (b) COMMON VENTS, HORIZONTAL DRAINS.

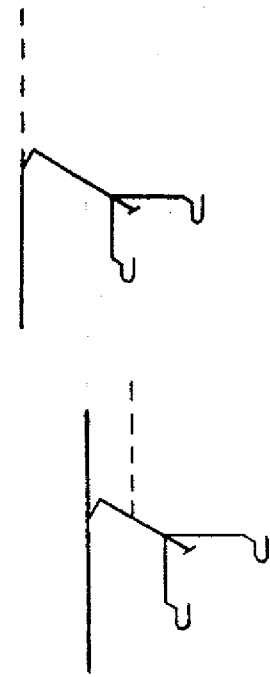
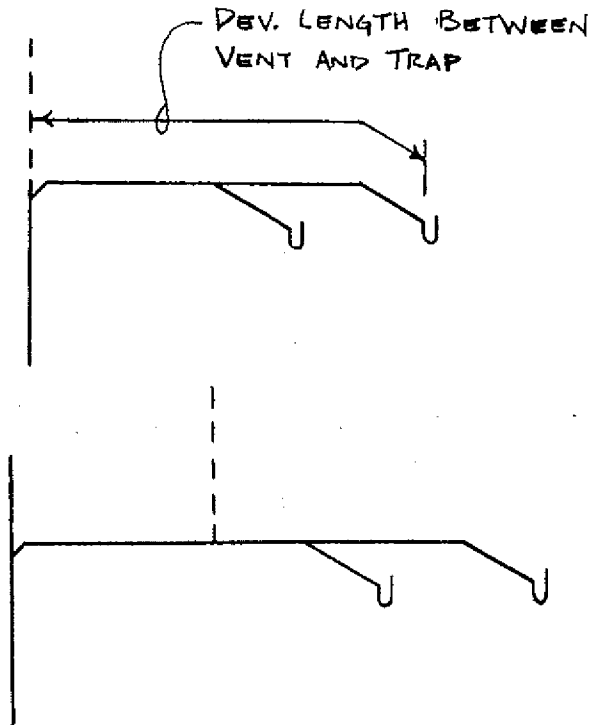

A-82.31 (12) ISLAND FIXTURE VENTING.

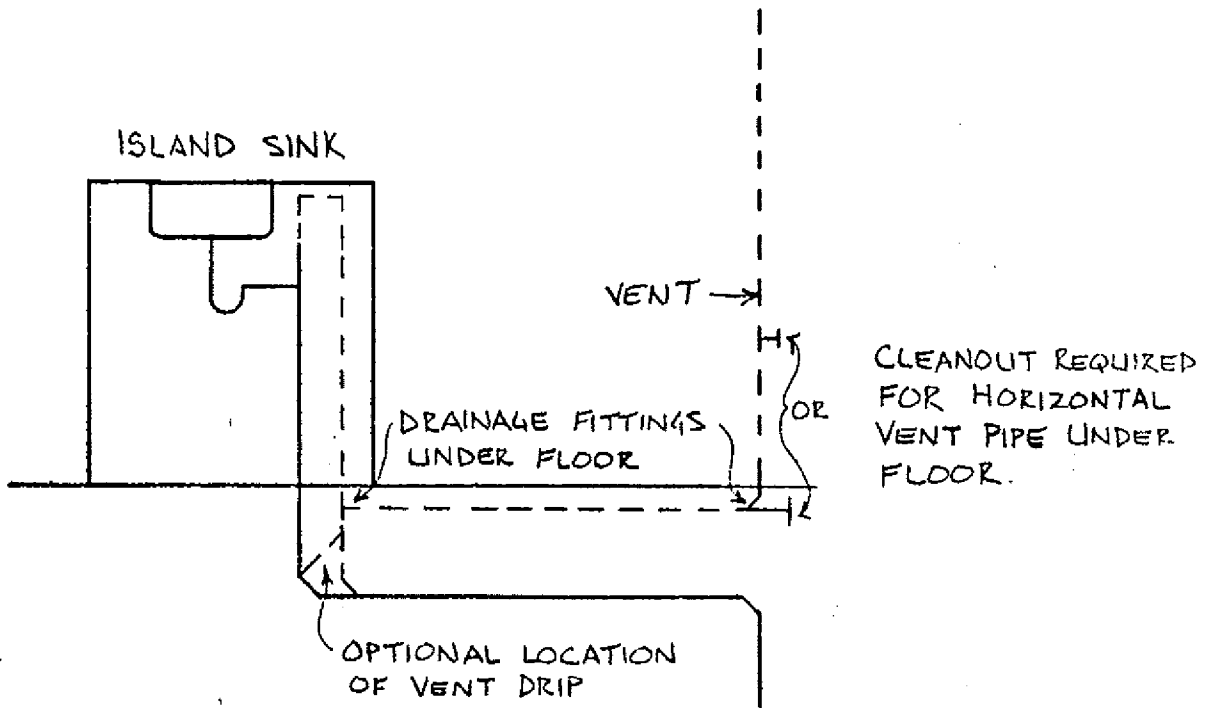

A-82.31 (13) (a) VERTICAL WET VENTS.

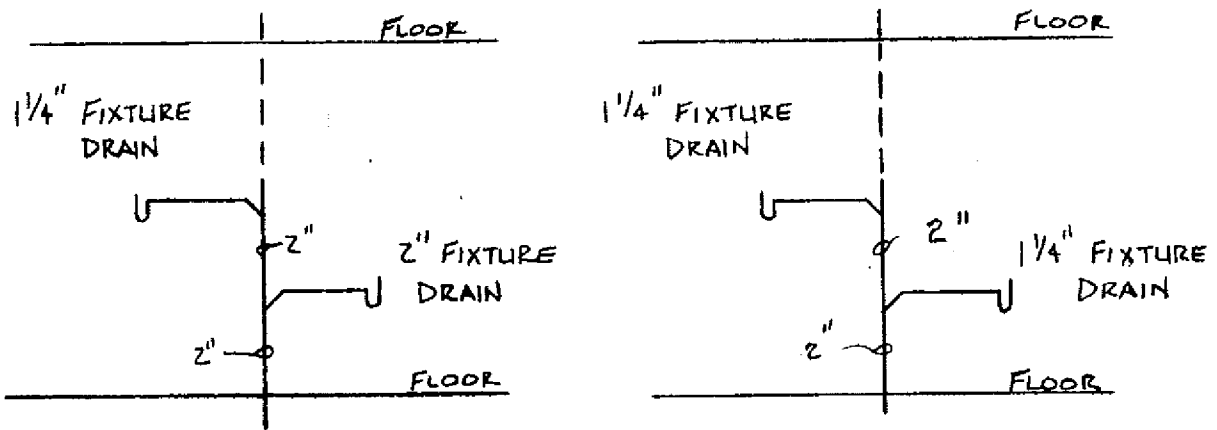

A-82.31 (13) (b) HORIZONTAL WET VENTS.

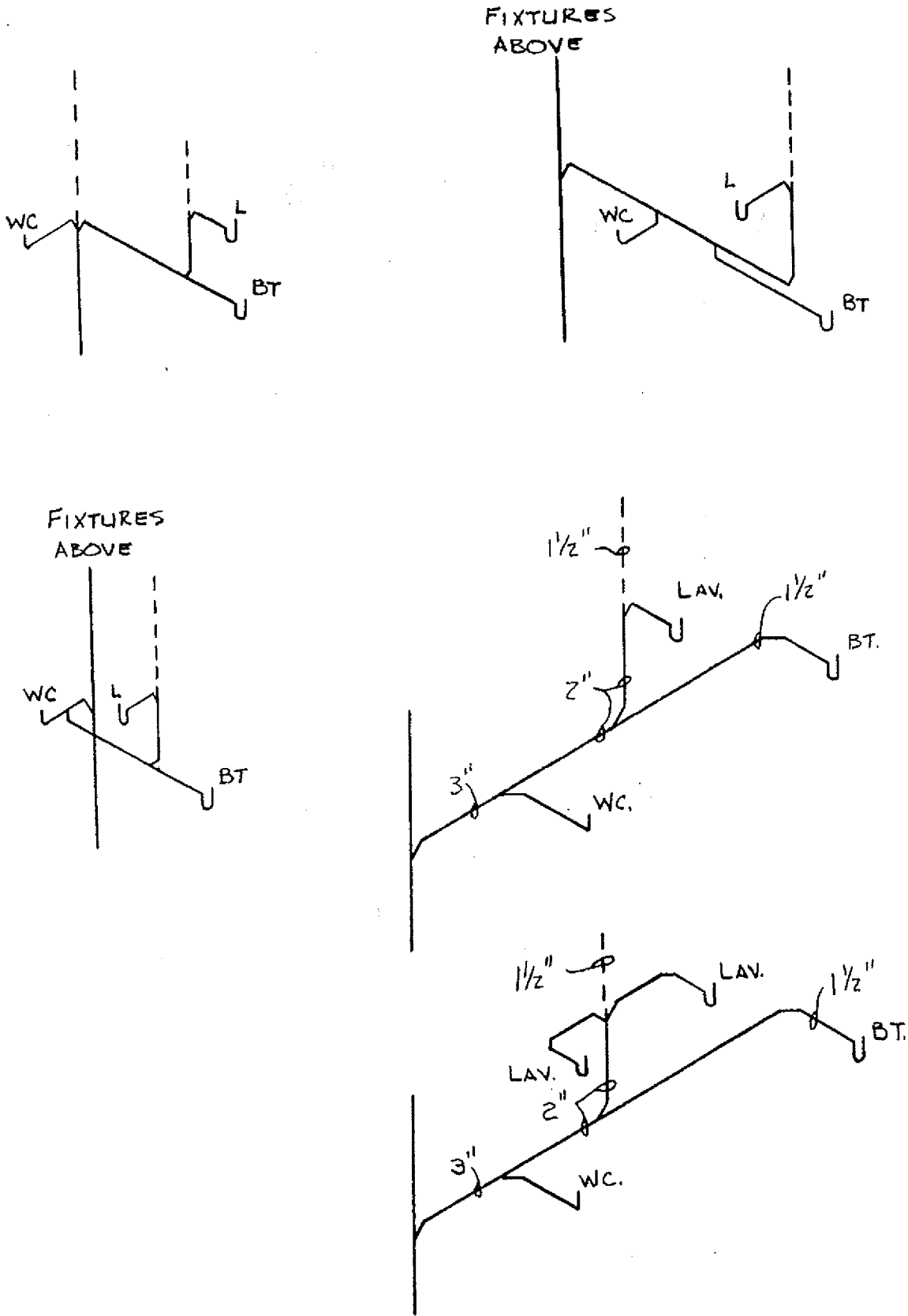

A-82.31 (13) (b) HORIZONTAL WET VENTS.

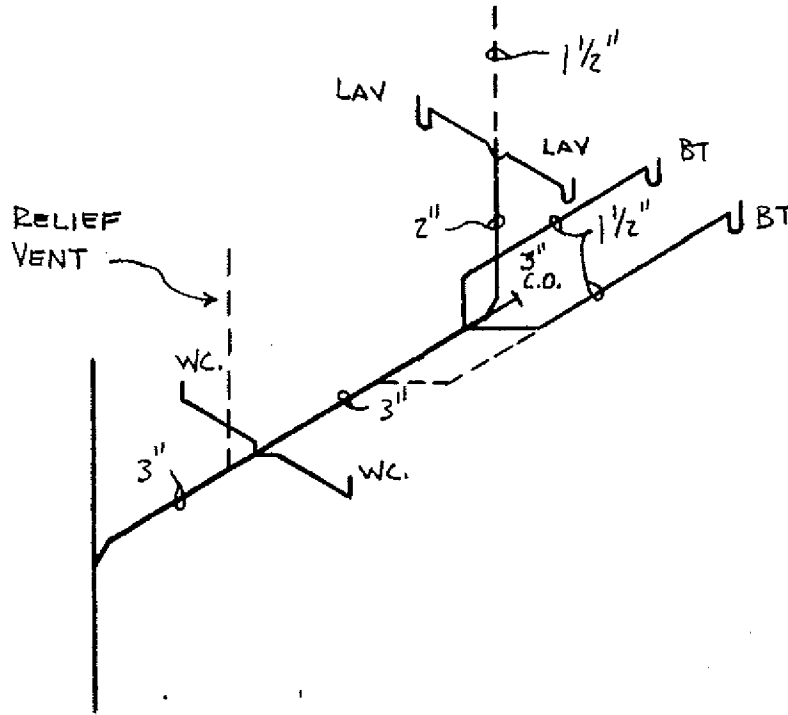

HORIZONTAL WET VENTS

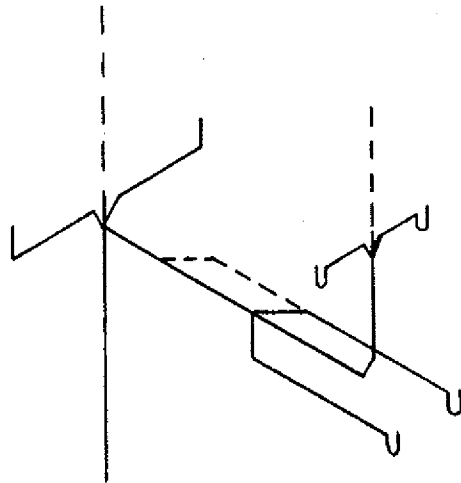

A-82.31 (13) (c) WET VENTING - FLOOR OUTLET FIXTURES.

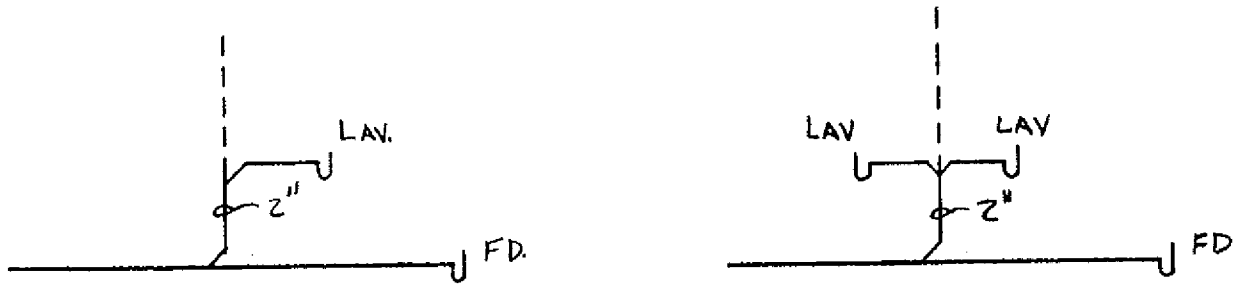

INDIVIDUAL VENT FOR FLOOR OUTLET FIXTURE
SERVING AS A WET VENT

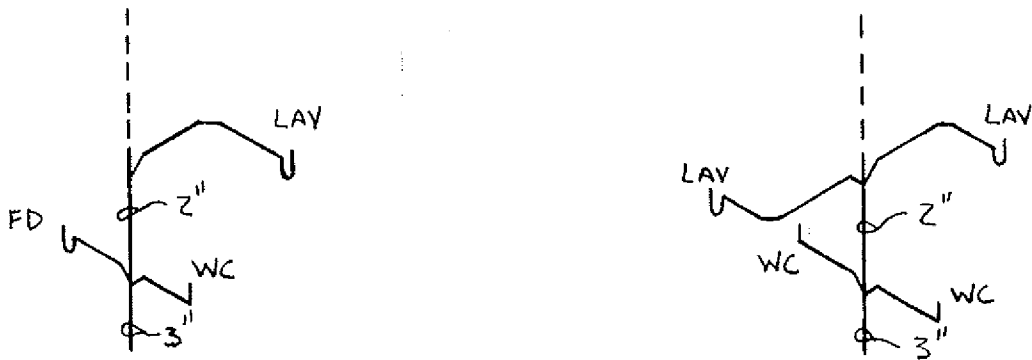

COMMON VENT FOR FLOOR OUTLET FIXTURES
SERVING AS A WET VENT

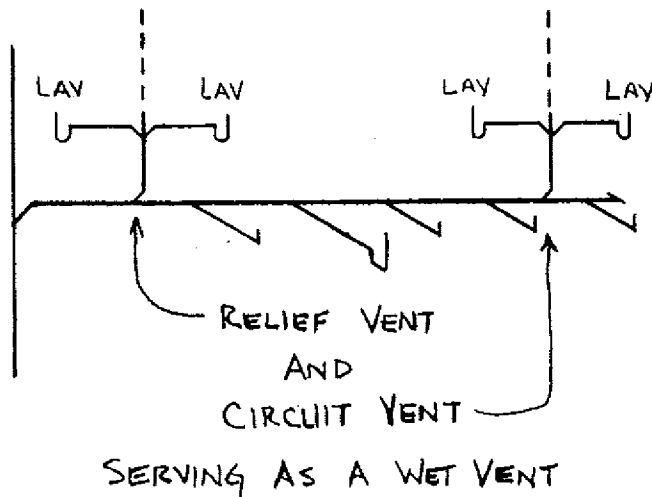

A-82.31 (14) (a) and (b) SIZING VENT STACKS AND STACK VENTS.

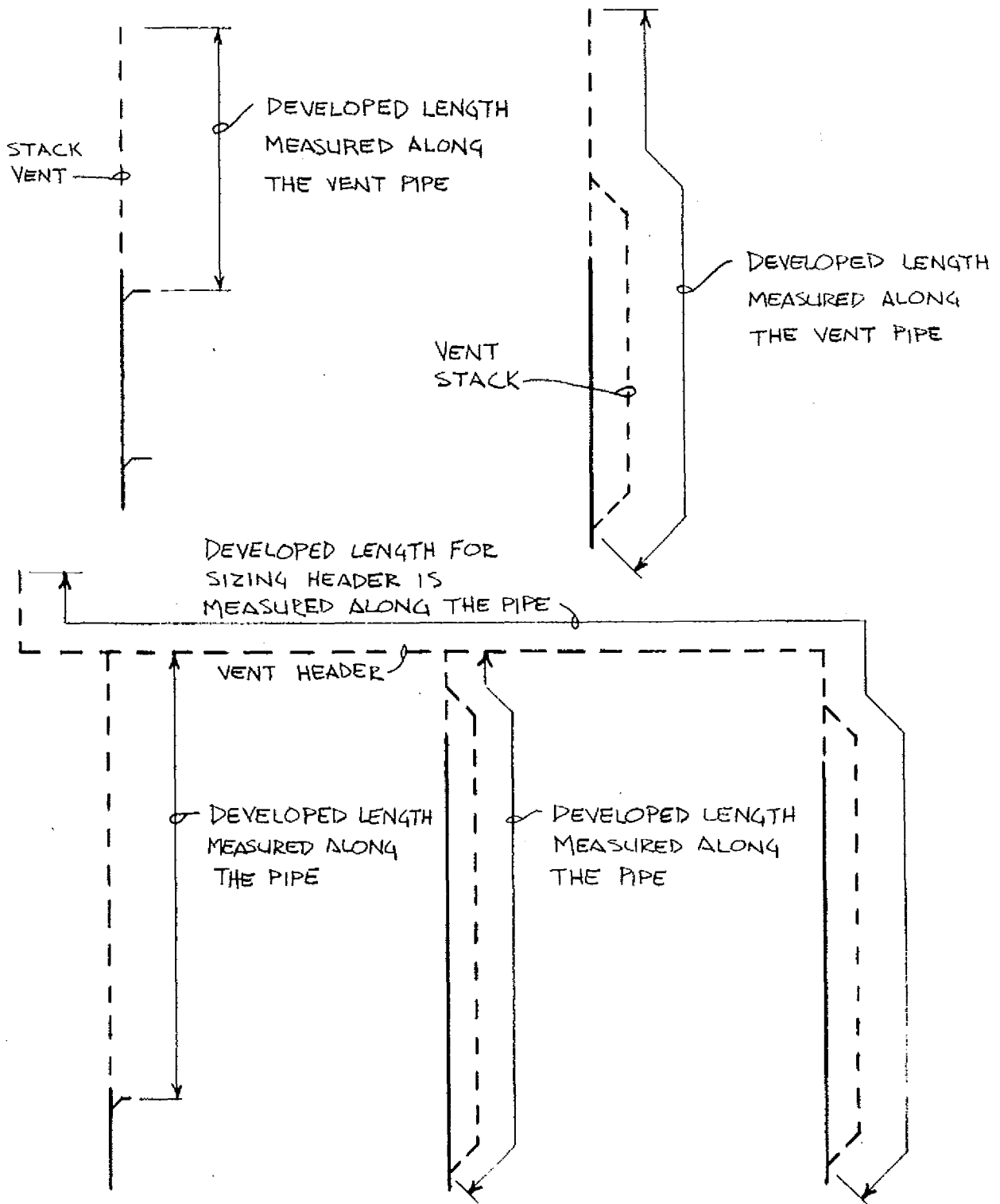

A-82.31 (14) (c) SIZING BRANCH VENTS.

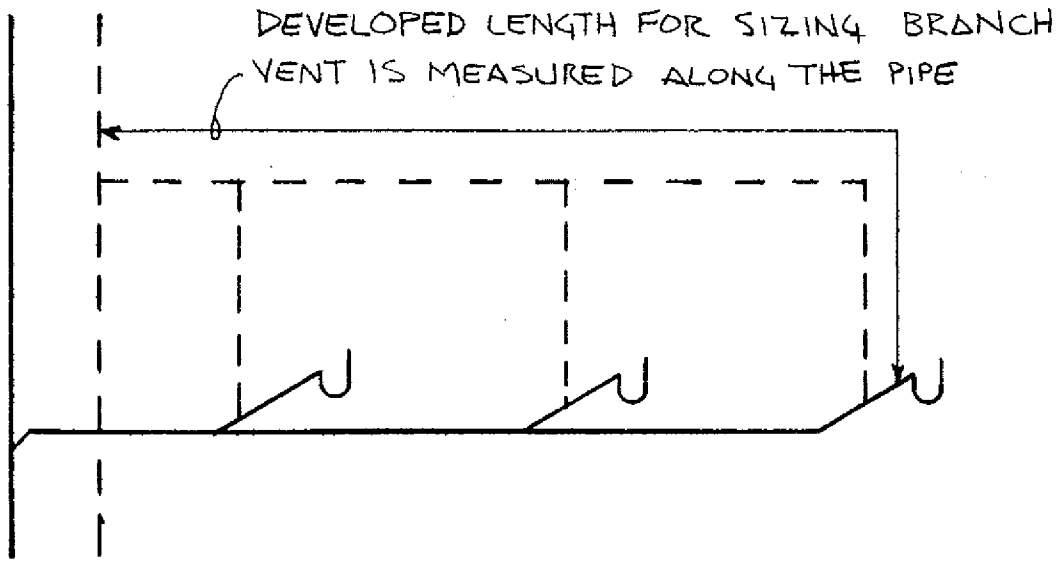

A-82.31 (14) (d) SIZING INDIVIDUAL VENTS.

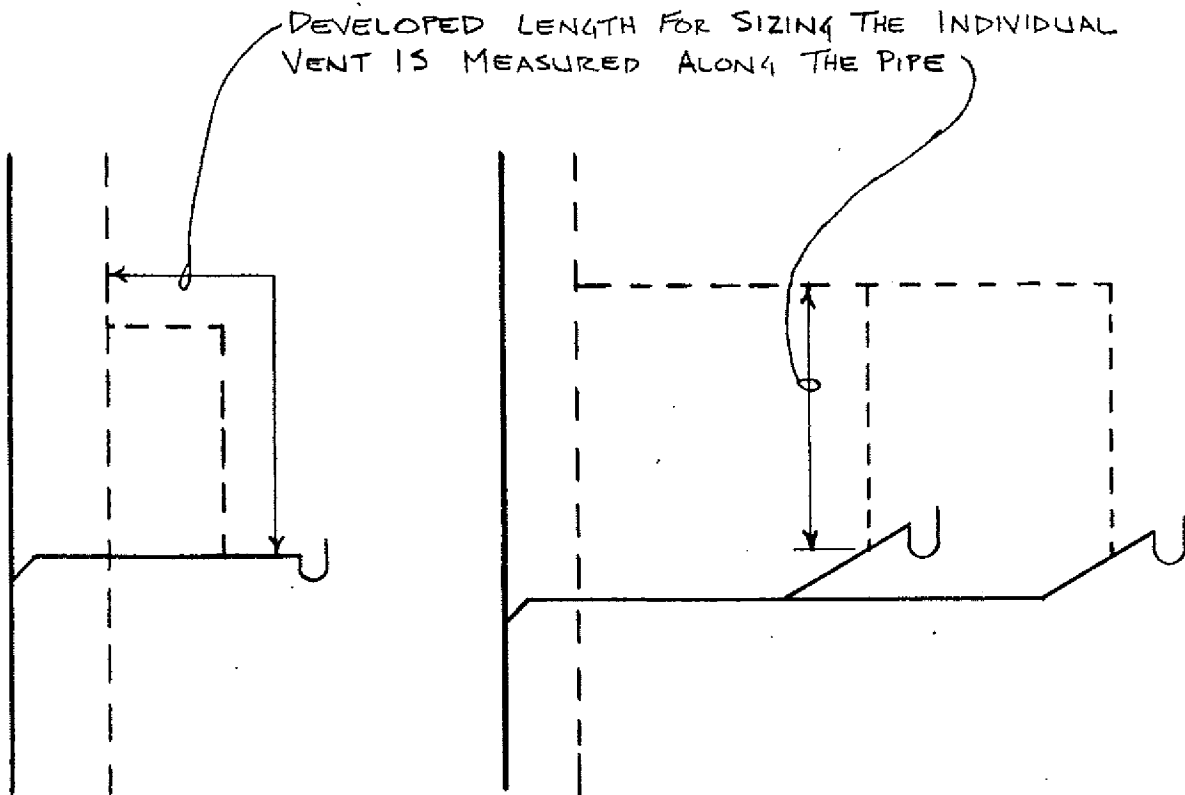

A-82.31 (14) (c) SIZING BRANCH VENTS SERVING A WET VENT.

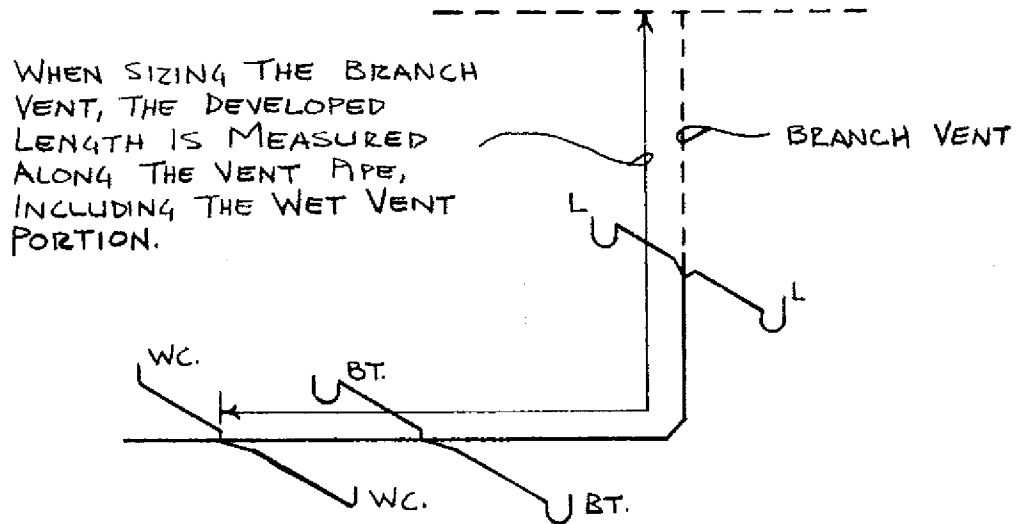
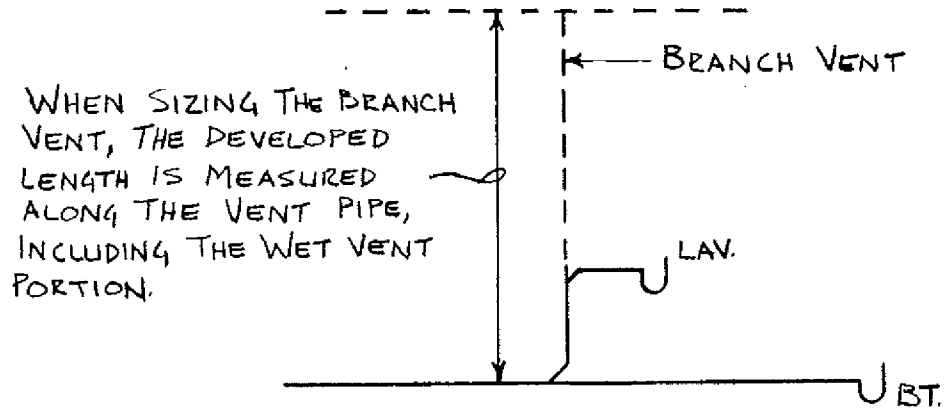

A-82.31 (15) (a) VENT GRADES AND CONNECTIONS.

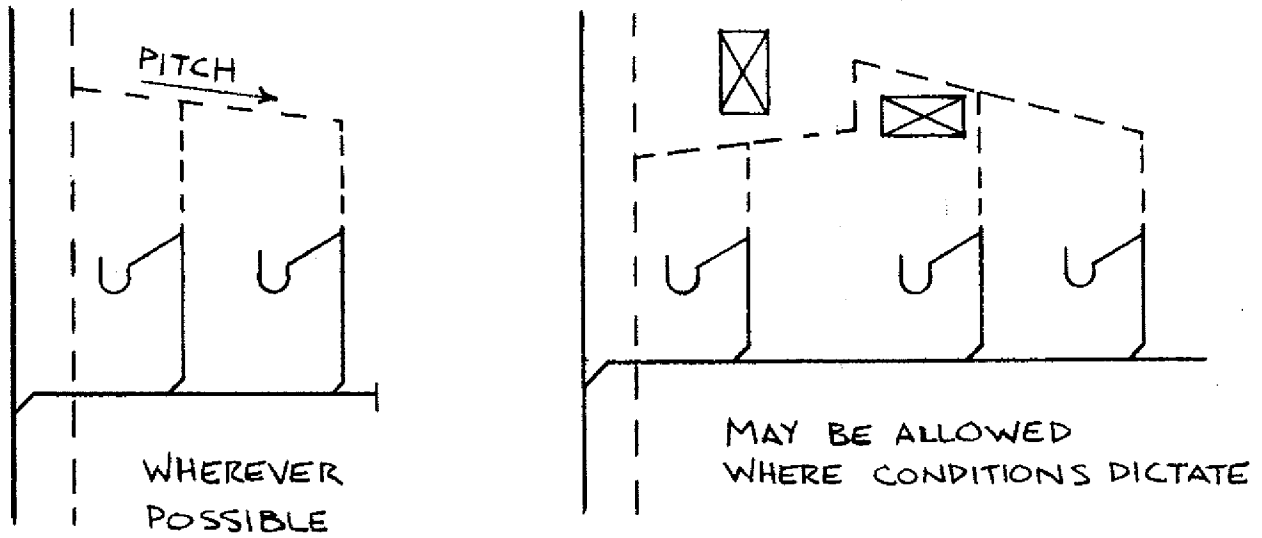

A-82.31 (15) (b) VENT GRADES AND CONNECTIONS.

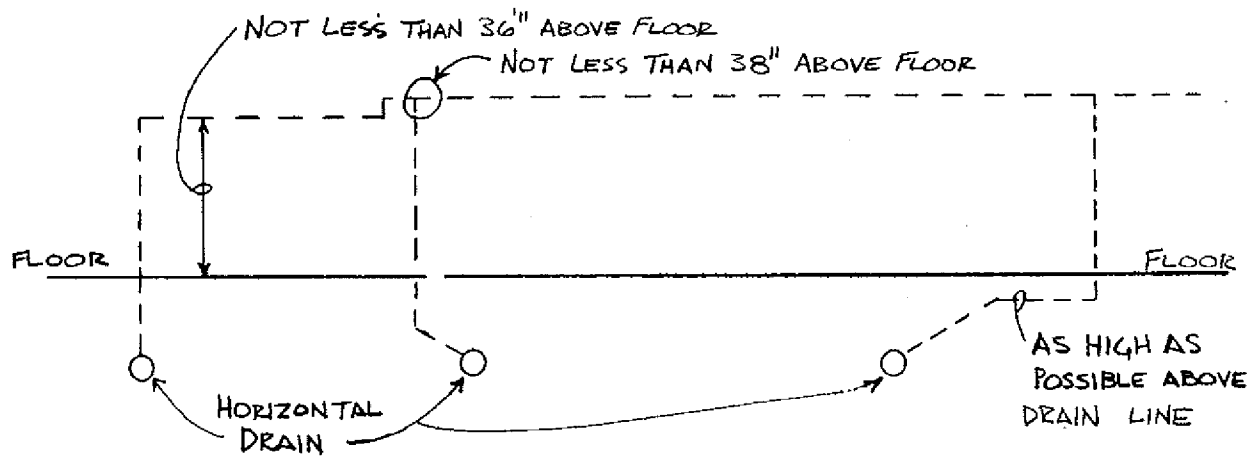

A-82.31 (16) VENT TERMINALS.

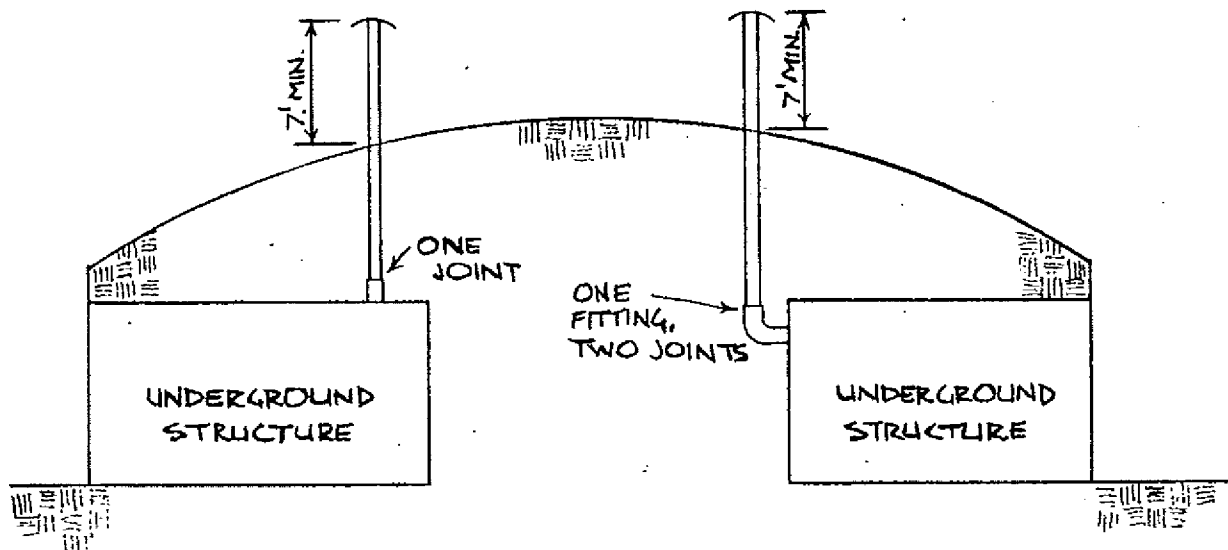
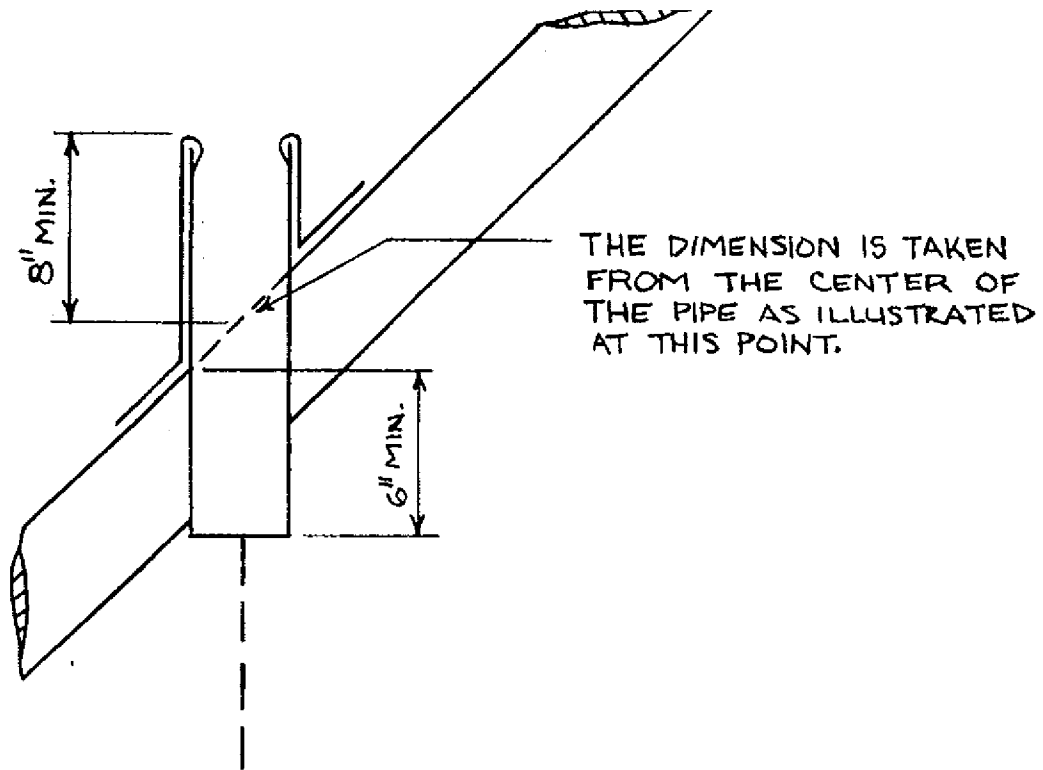

VENT TERMINALS FOR UNDERGROUND STRUCTURES

A-82.31 (17) (a) COMBINATION DRAIN AND VENT STACKS.

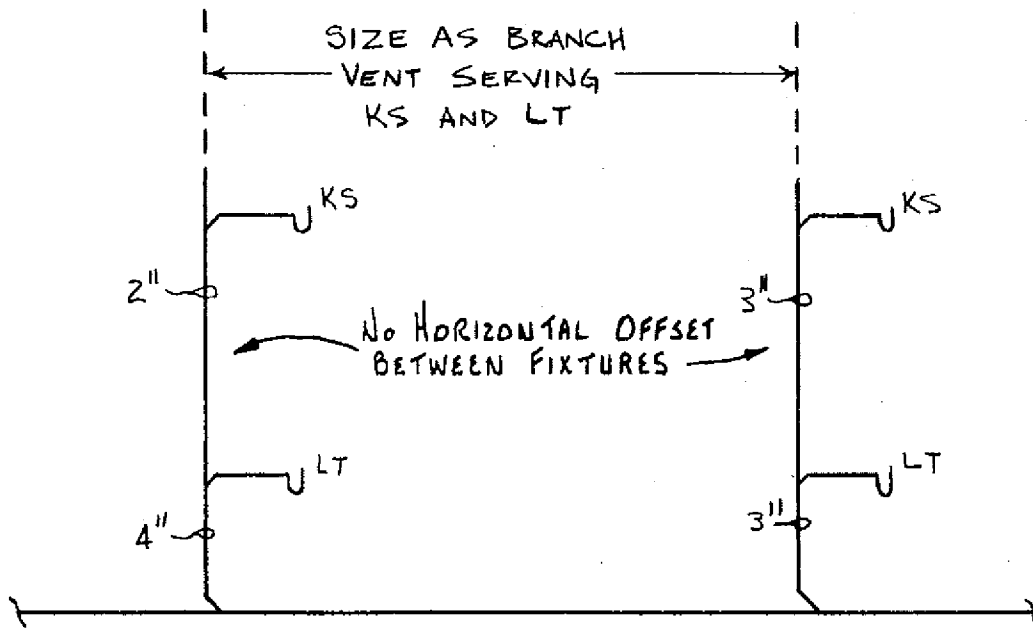
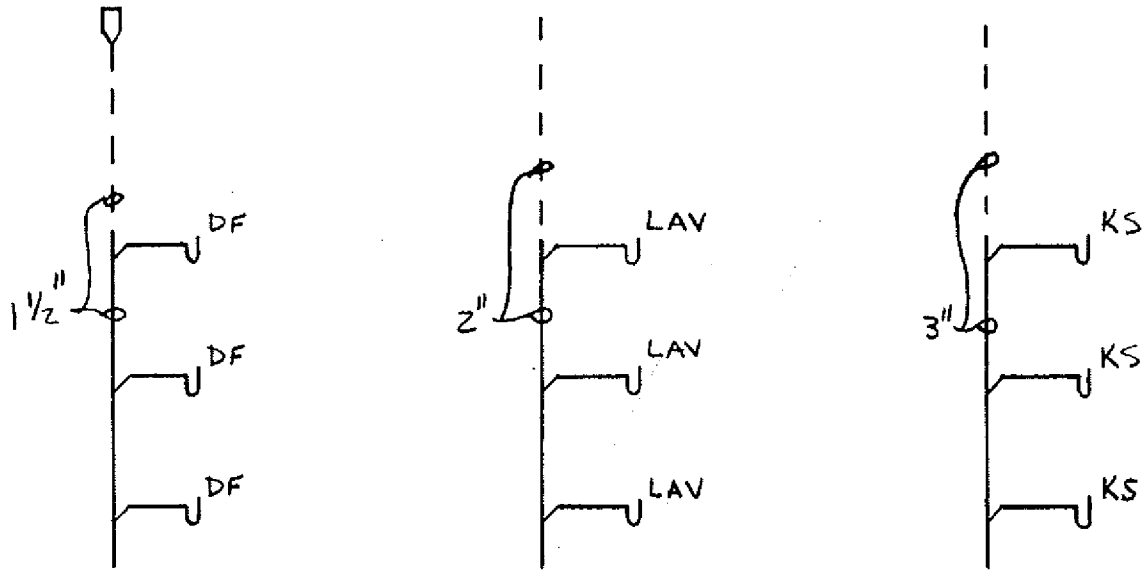

A-82.31 (17) (b) COMBINATION DRAIN AND VENT BUILDING DRAIN.

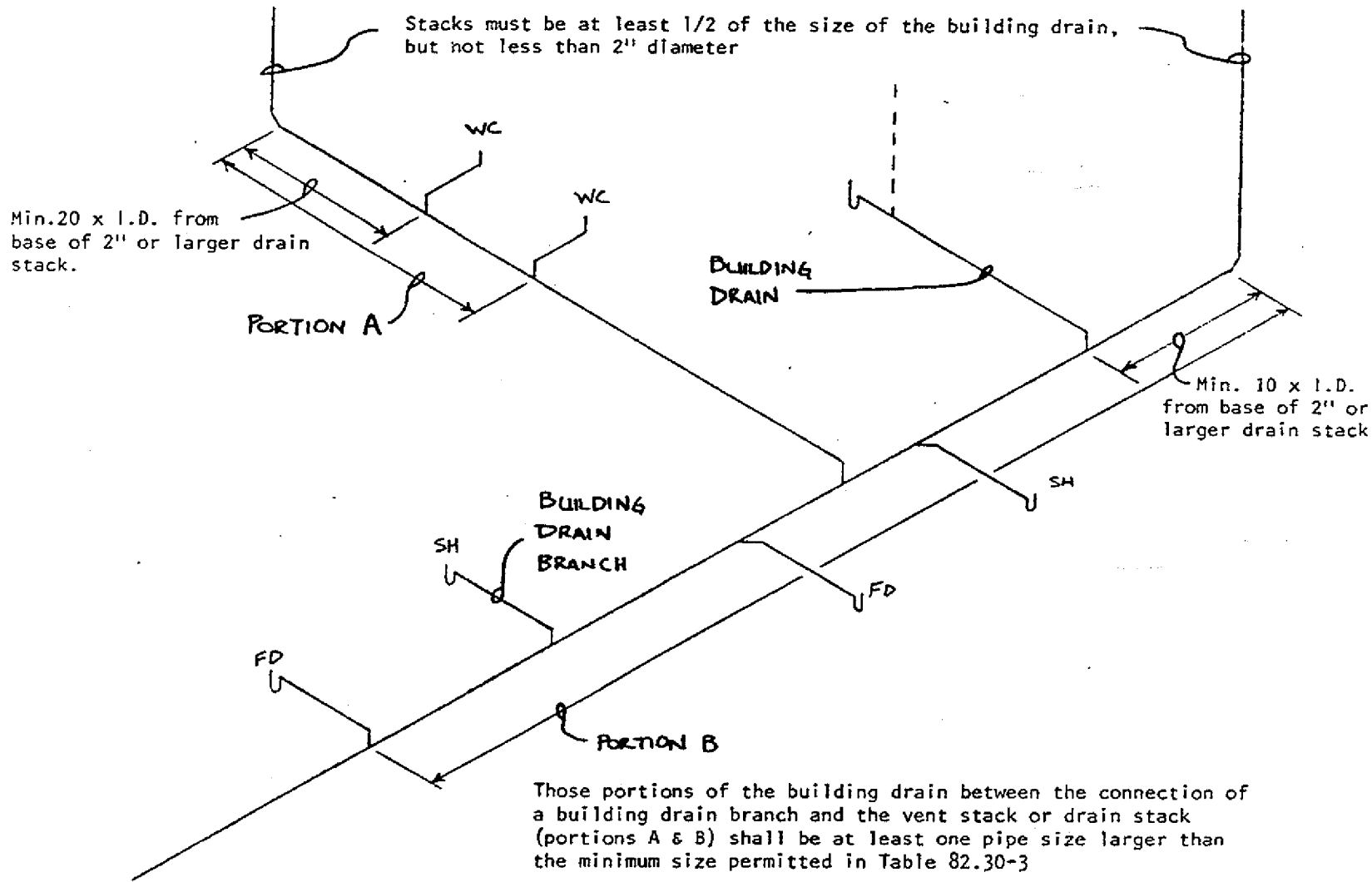

A-82.31 (17) (c) COMBINATION DRAIN AND VENT LABORATORY SINK VENTING.

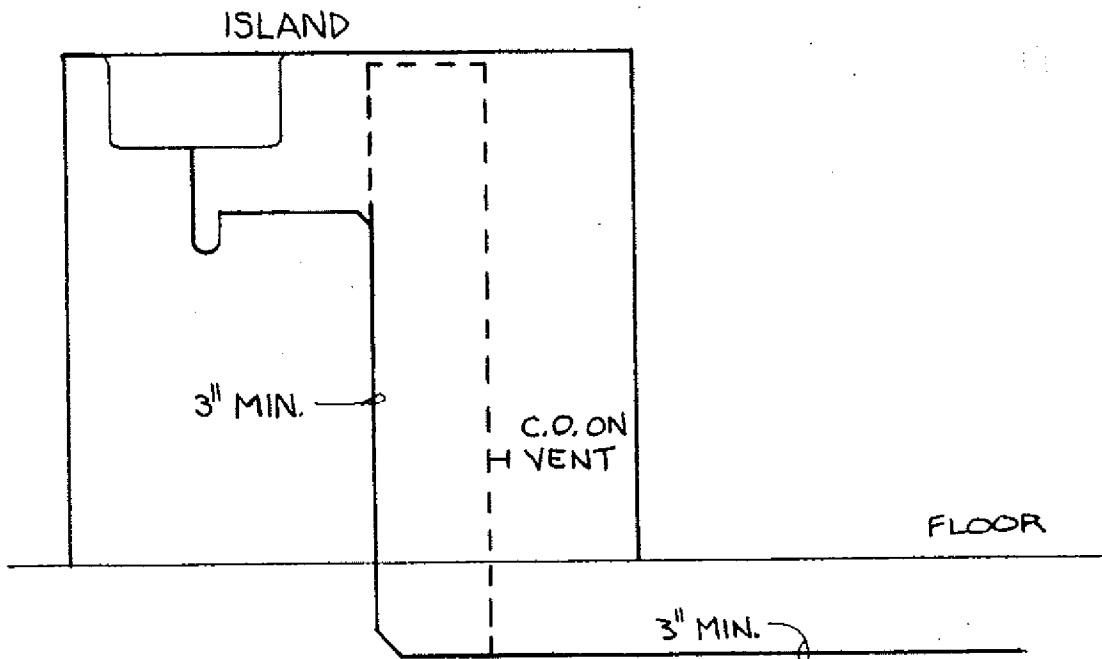
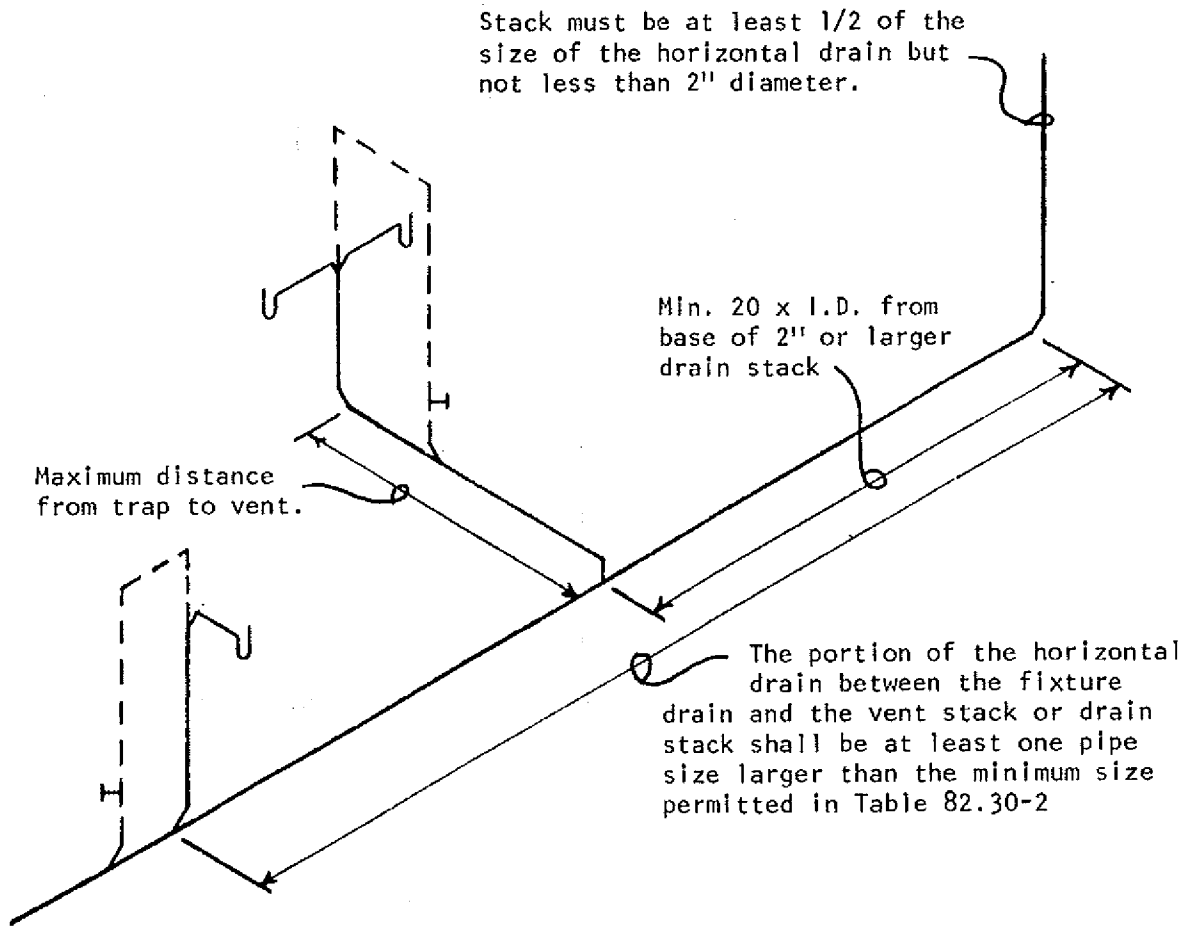

A-82.32 (4) (b) INSTALLATION OF TRAPS.

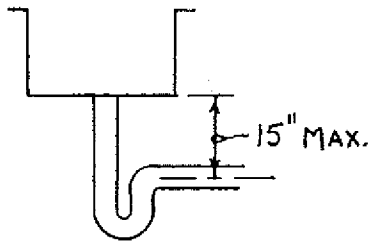

MOST FIXTURES

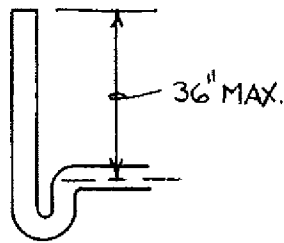

STANDPIPE

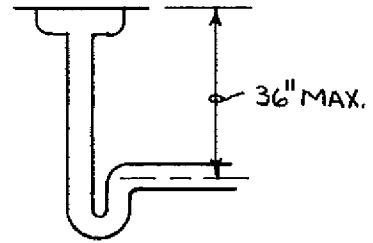

FLOOR DRAIN

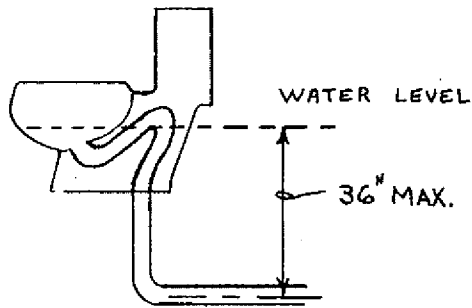

VERTICAL DISTANCE BETWEEN FIXTURE DRAIN OUTLET AND TRAP

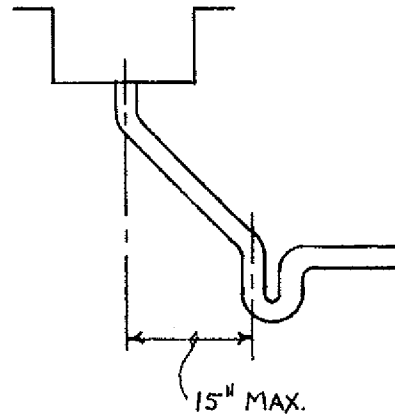
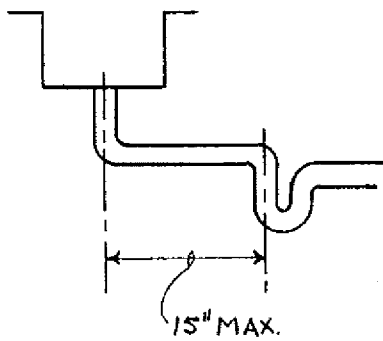

HORIZONTAL DISTANCE BETWEEN FIXTURE DRAIN OUTLET AND TRAP

A-82.33 (6) INDIRECT AND LOCAL WASTE PIPING.

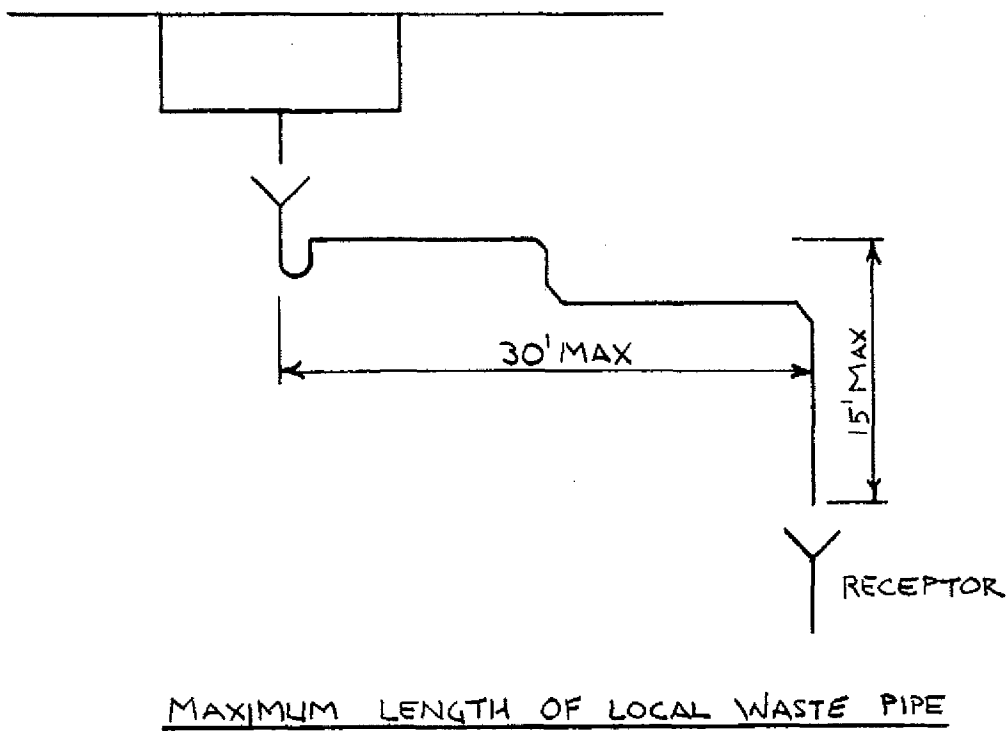
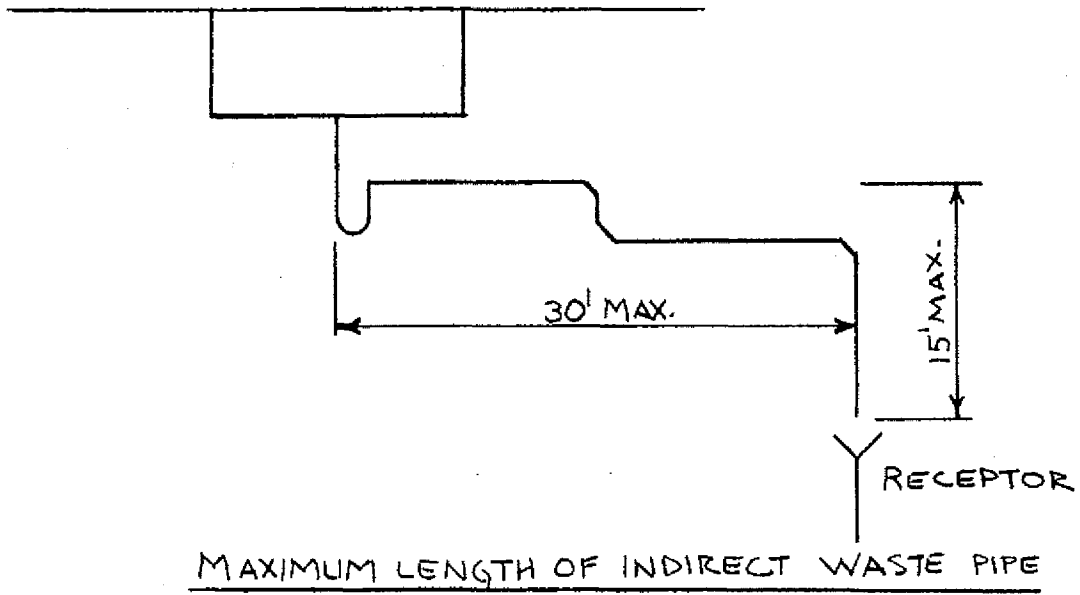

A-82.33 (7) AIR-GAPS AND AIR-BREAKS.

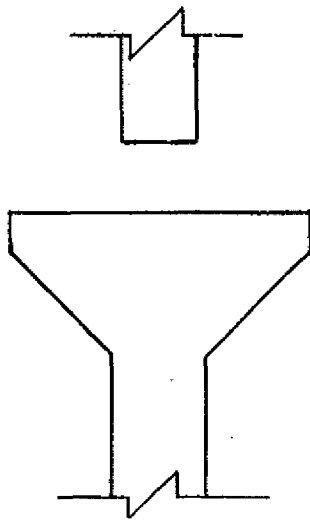

AIR GAP

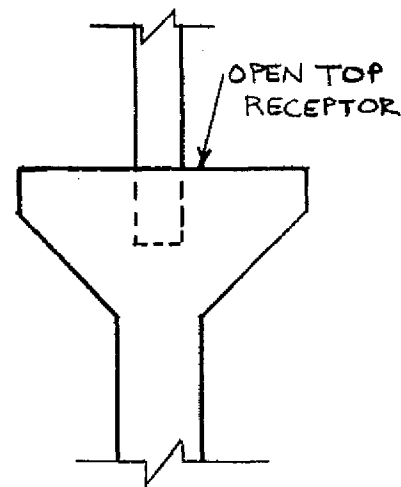

AIR BREAK

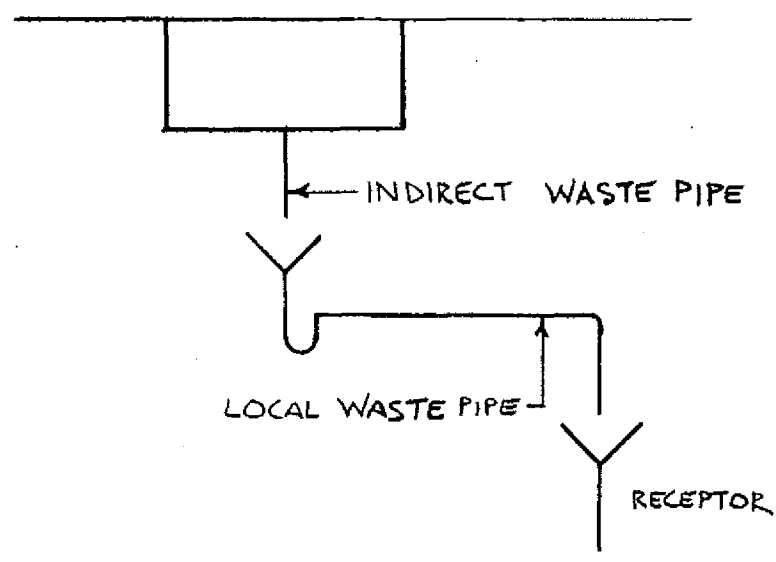

A-82.33 (8) (a) WASTE SINKS AND STANDPIPES.

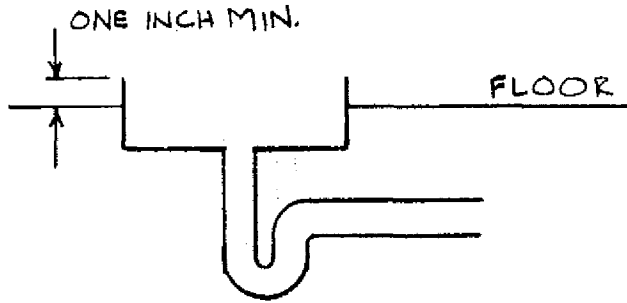

WASTE SINK IN FLOOR

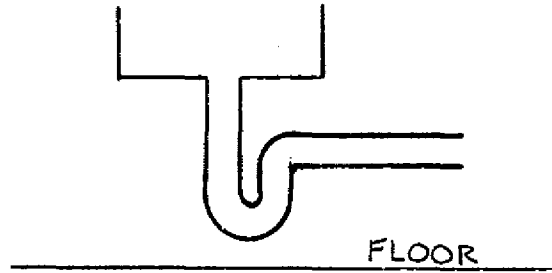

WASTE SINK ABOVE FLOOR

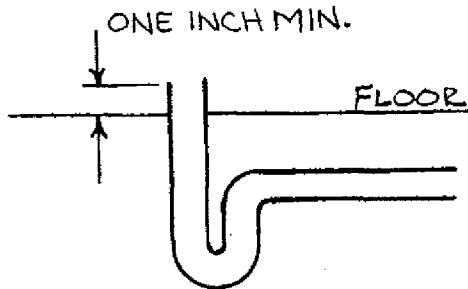

STANDPIPE IN FLOOR

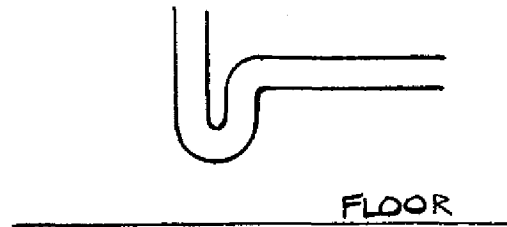

STANDPIPE ABOVE FLOOR

A-82.33 (8) (b) FLOOR SINKS.

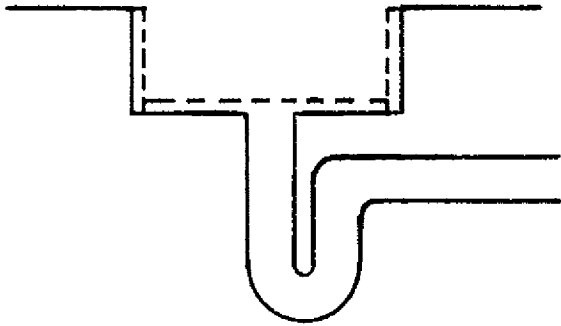

FLOOR SINK WITH BASKET

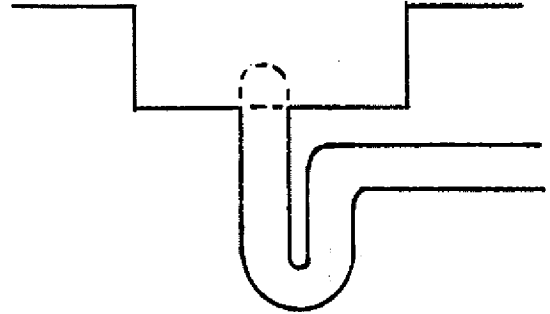

FLOOR SINK WITH DOME STRAINER

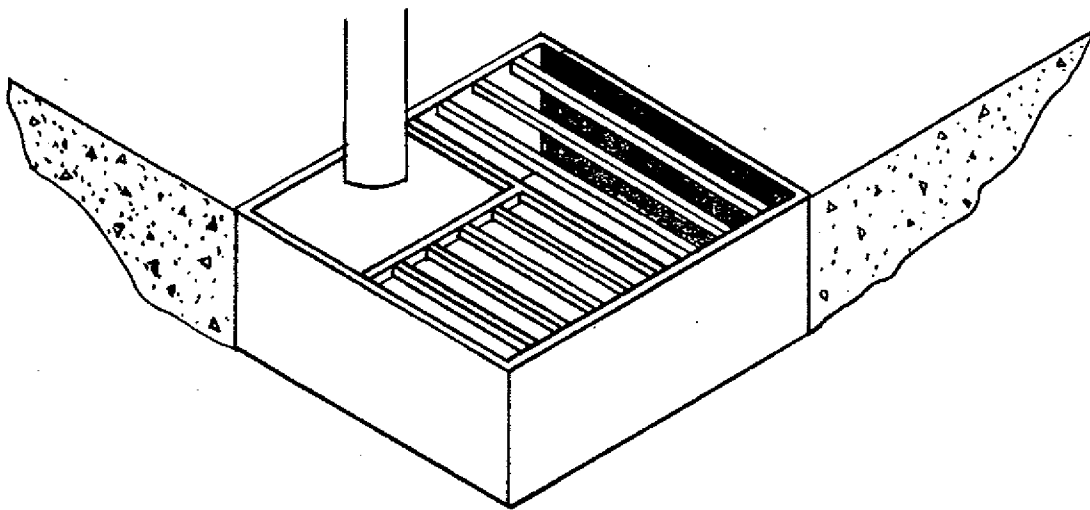

FLOOR SINK WITH GRATE OPENING
FOR AIR GAP

A-82.33 (8) (e) LOCAL WASTE PIPING.

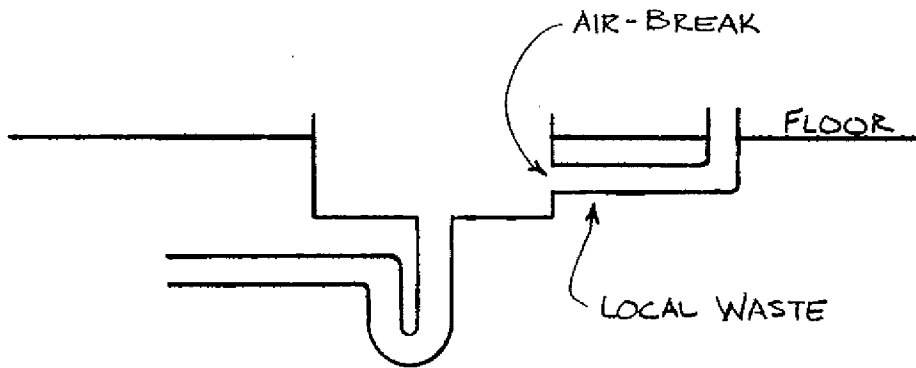

LOCAL WASTE LEADING TO A WASTE SINK,
FLOOR SINK OR FLOOR DRAIN

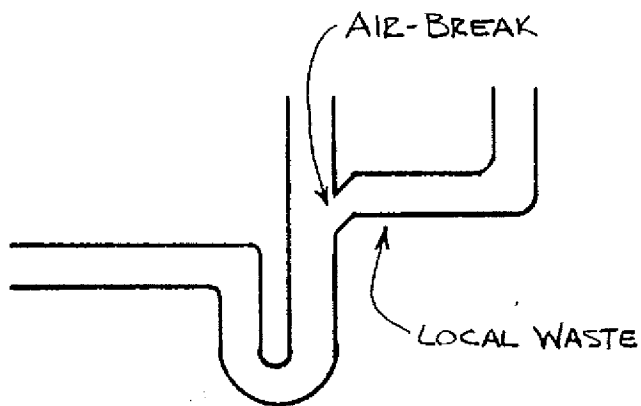

LOCAL WASTE LEADING TO A STANDPIPE

A-82.33 (8) (c) LOCAL WASTE PIPING SERVING WATER HEATER RELIEF VALVES.

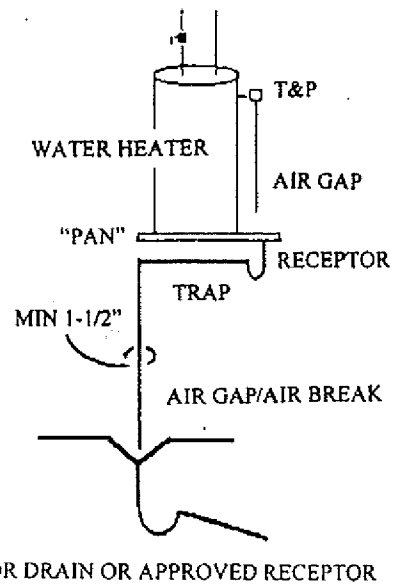
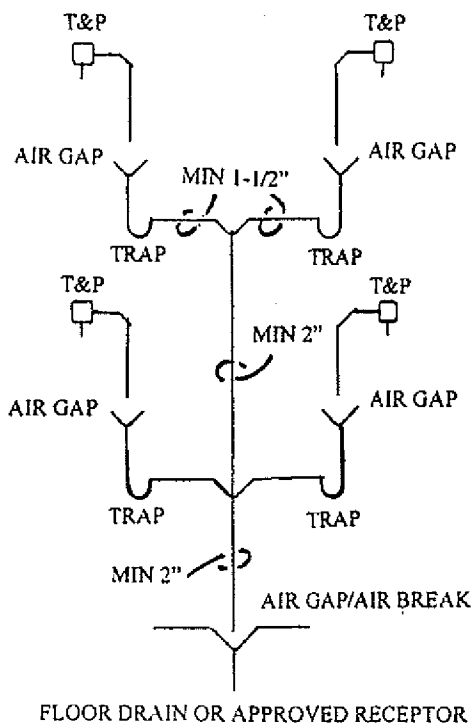
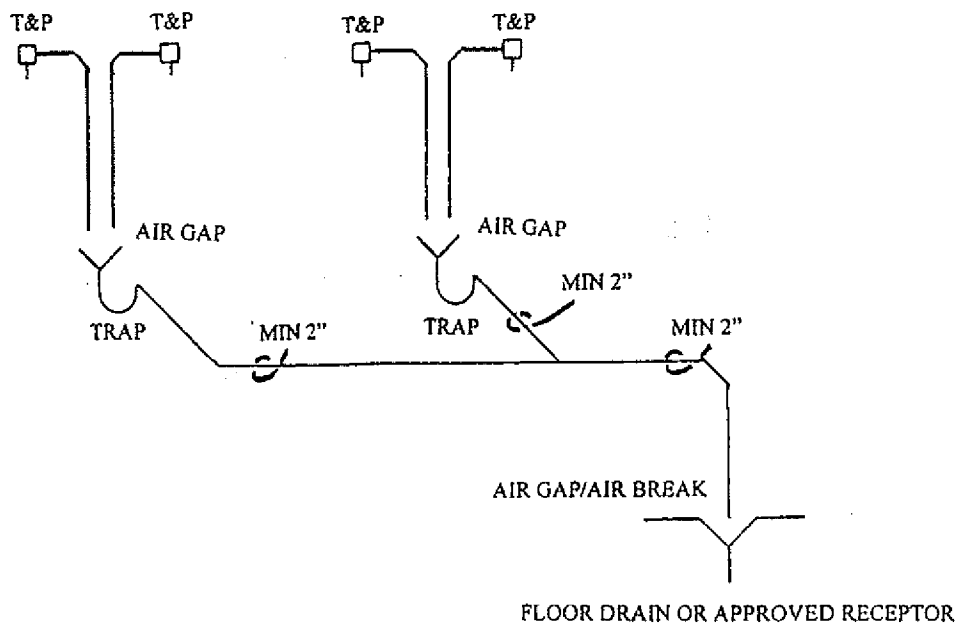

A-82.33 (9) (c) COMMERCIAL GRAVITY DISCHARGE-TYPE CLOTHES WASHERS.

TRENCH TYPE LAUNDRY RECEPTOR

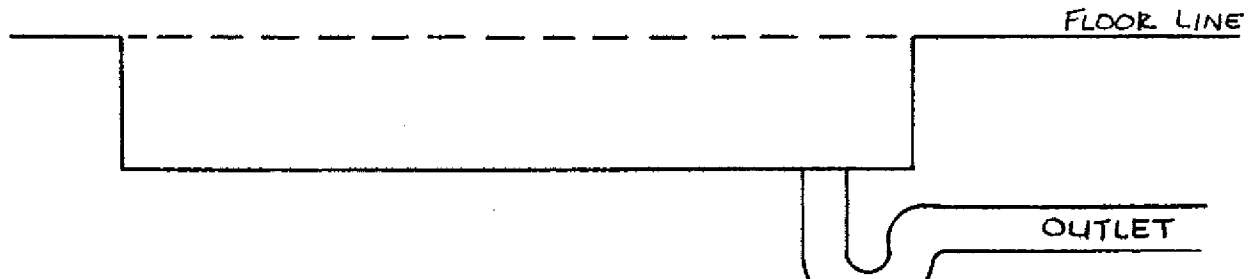

A-82.33 (9) (d) RESIDENTIAL-TYPE DISHWASHERS.

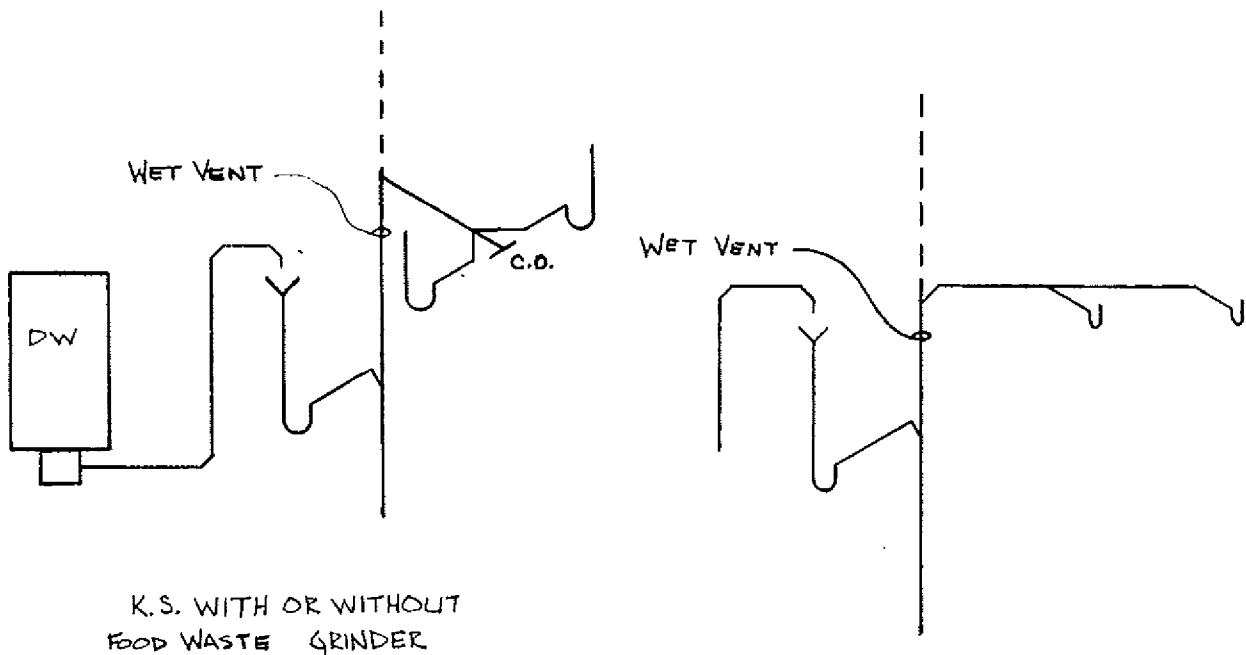

DISWASHER DISCHARGING TO A STANDPIPE
BELOW THE COUNTER TOP.

A-82.33 (9) (d) RESIDENTIAL-TYPE DISHWASHERS.

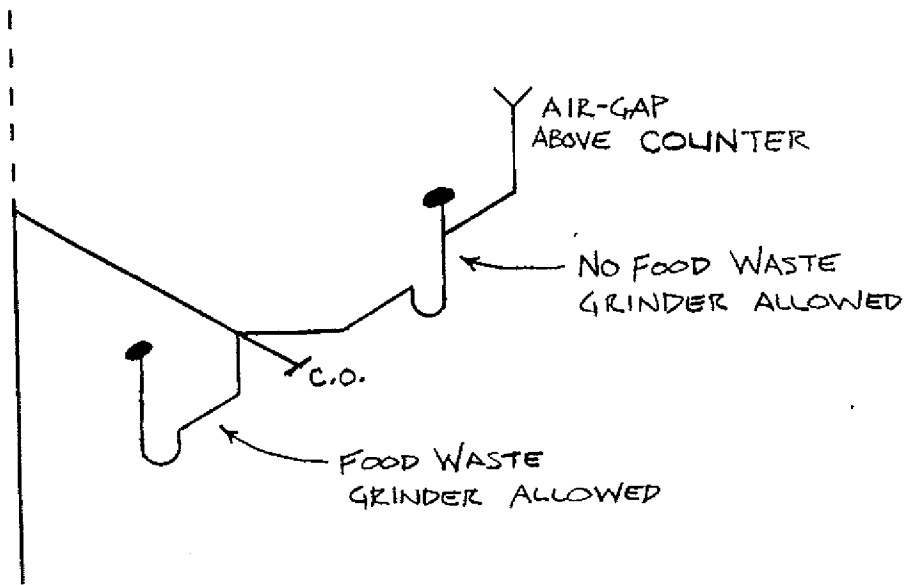
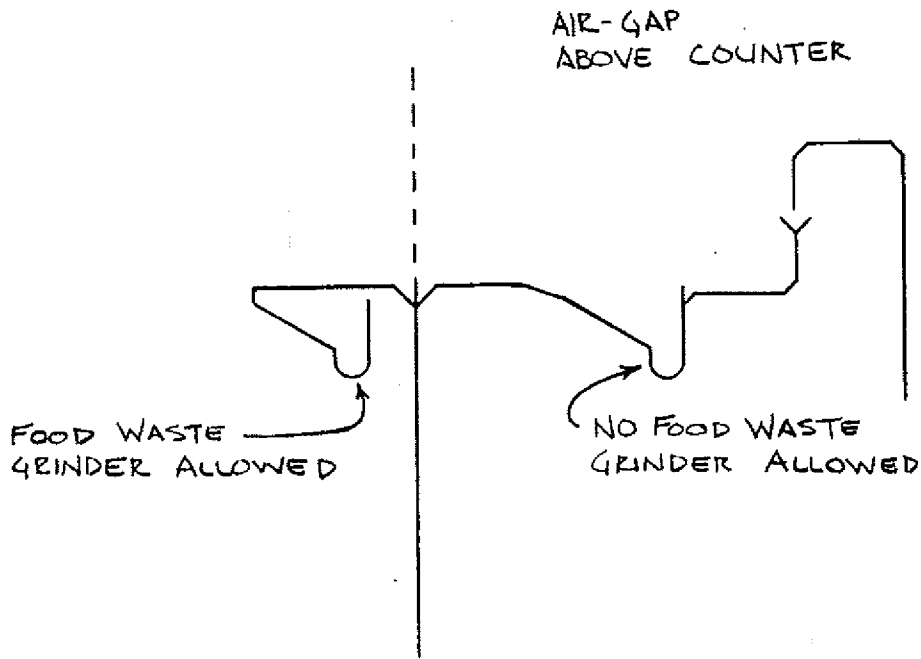

A-82.33 (9) (d) RESIDENTIAL-TYPE DISHWASHERS.

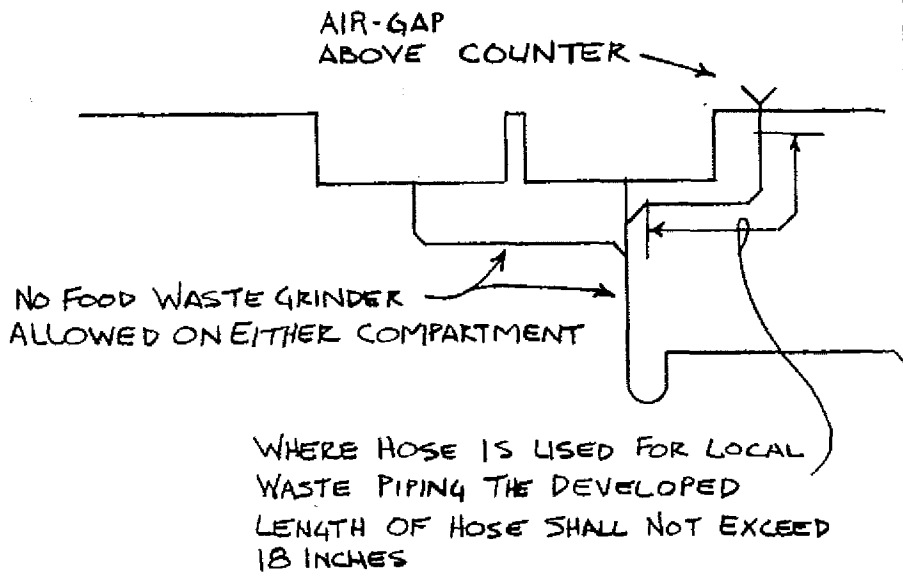
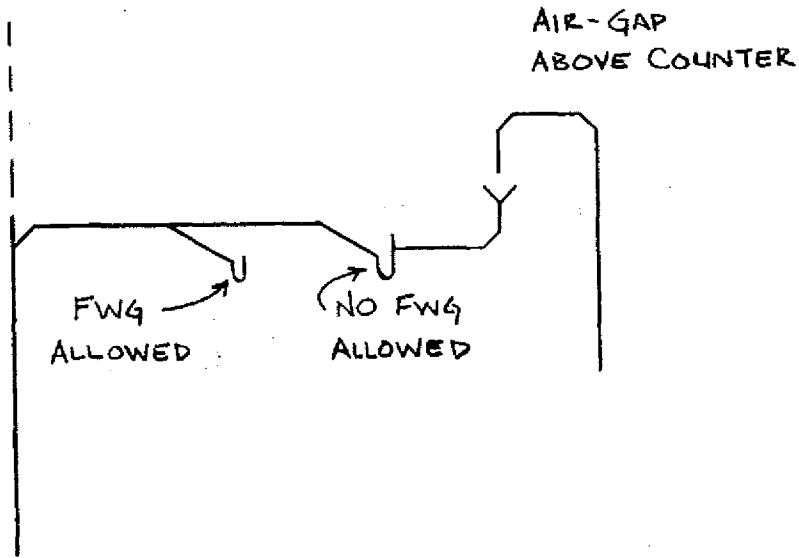

A-82.33 (9) (d) COMMERCIAL DISHWASHERS.

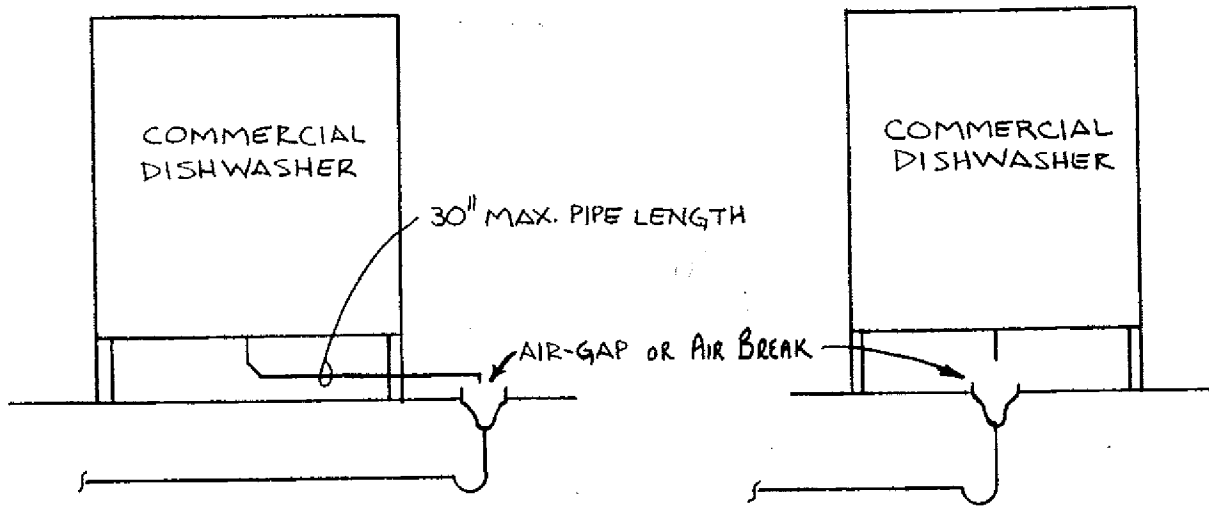

A-82.33 (9) (f) ELEVATOR PIT SUBSOIL AND FLOOR DRAINS.

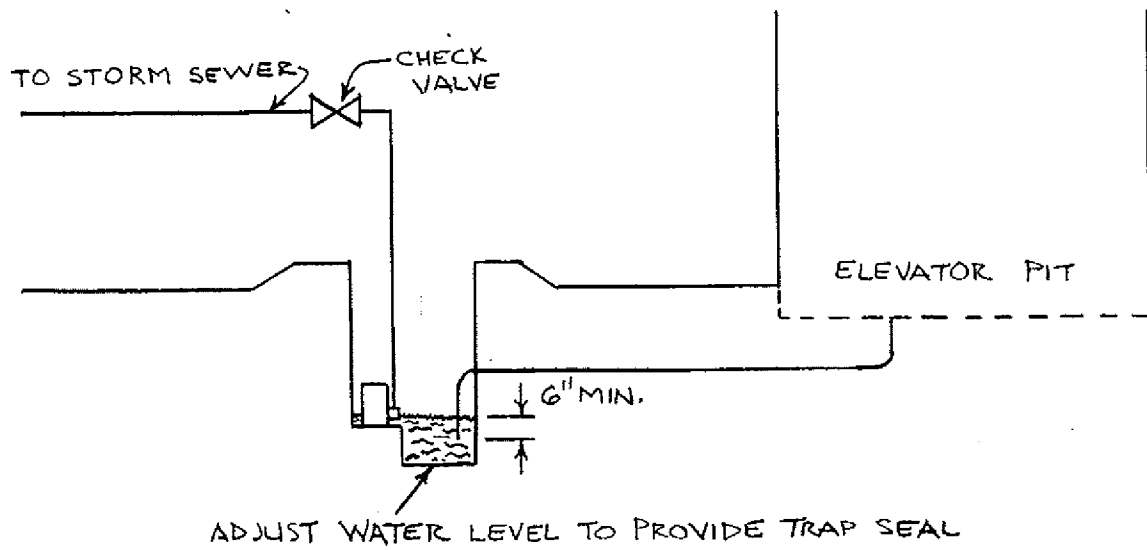

A-82.33 (9) (g) 1. BAR AND SODA FOUNTAIN SINKS.

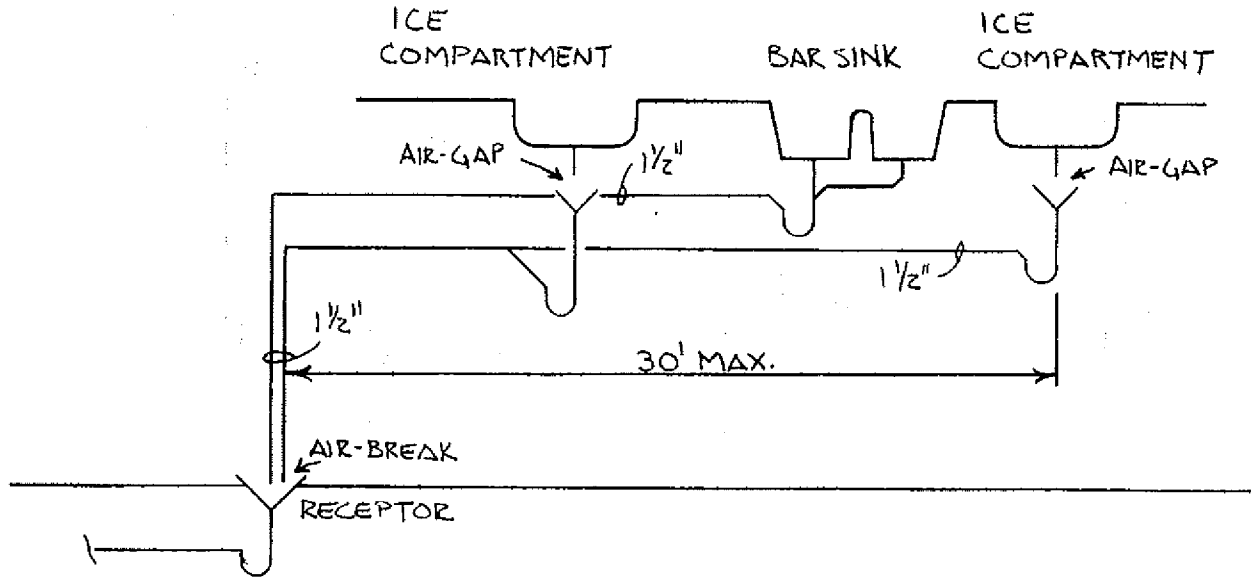

A-82.33 (9) (g) 2. BEER TAPS, COFFEE MAKERS, GLASS FILLERS AND SODA DISPENSERS.

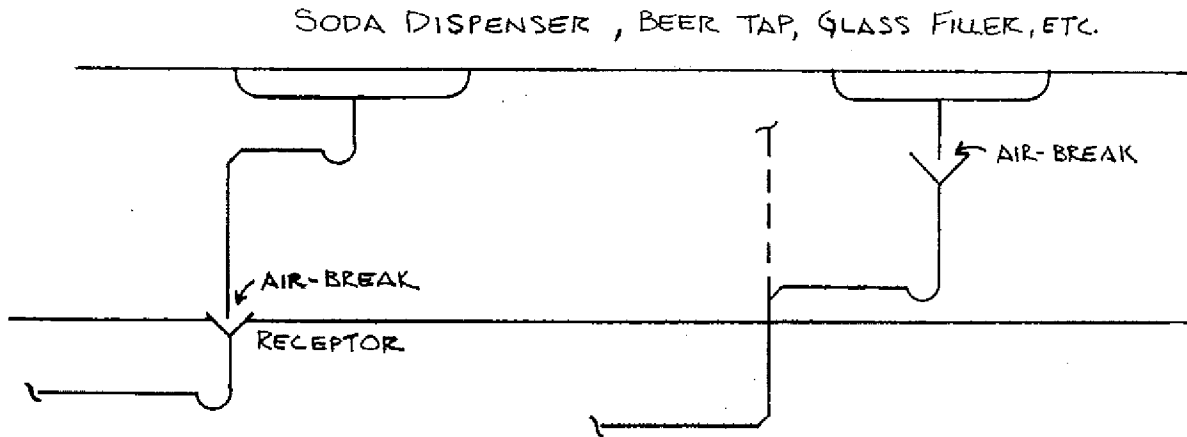

A-82.33 (9) (g) 3. NOVELTY BOXES, AND ICE COMPARTMENTS AND ICE CREAM DIPPER WELLS.

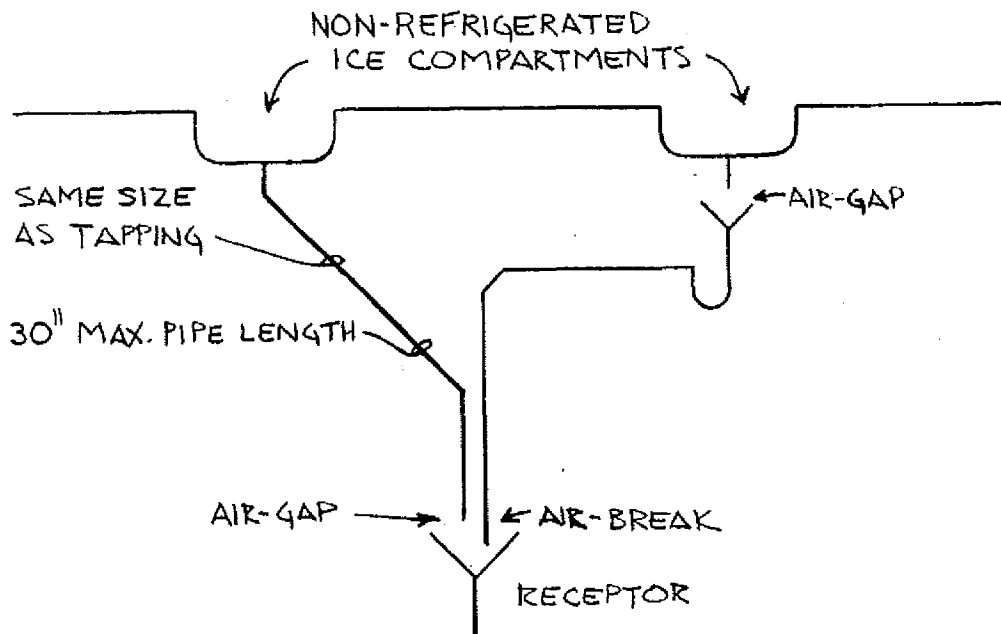
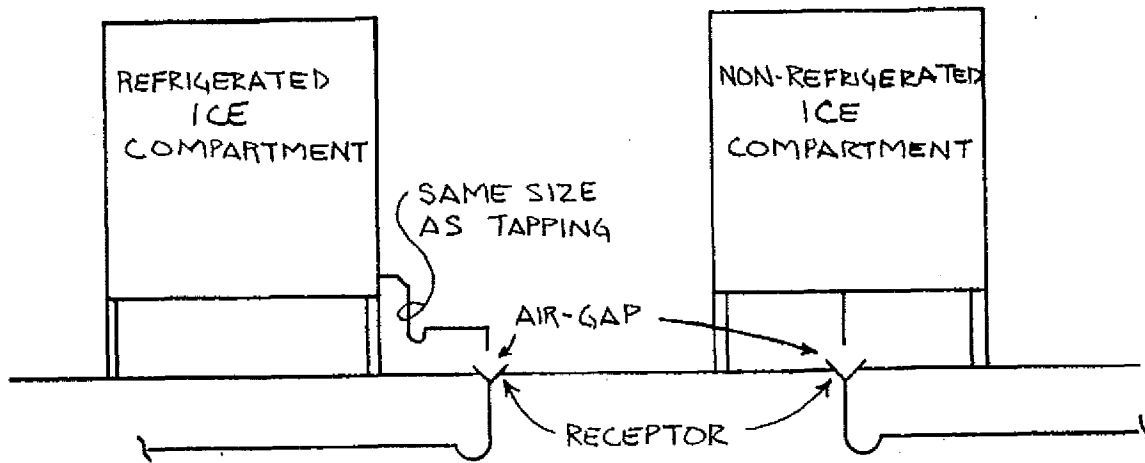

A-82.33 (9) (g) 4. REFRIGERATED FOOD STORAGE ROOMS, COMPARTMENTS, AND DISPLAY CASES.

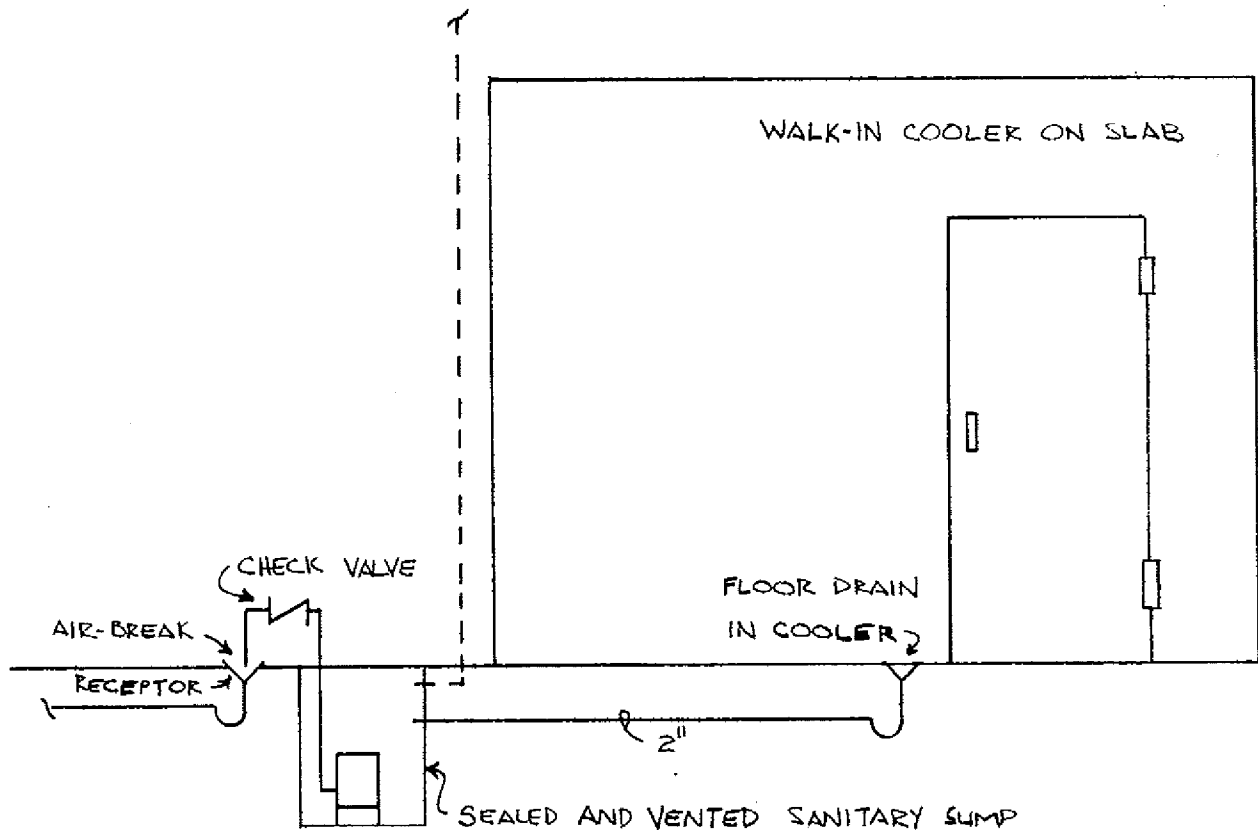
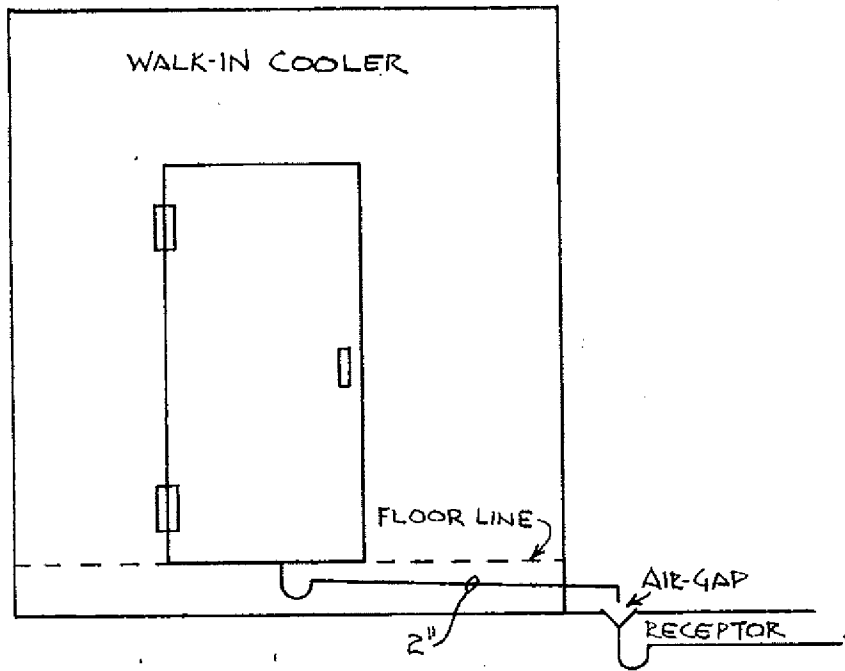

A-82.33 (9) (g) 5. MISCELLANEOUS FOOD HANDLING EQUIPMENT.

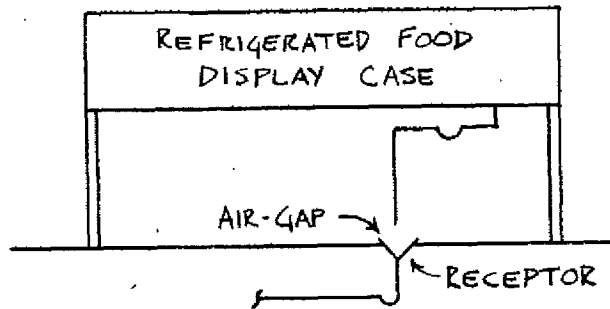
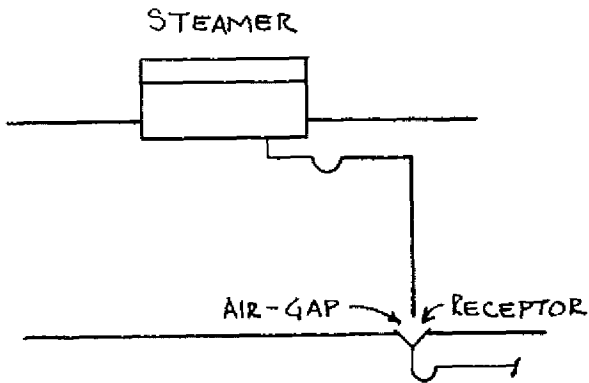
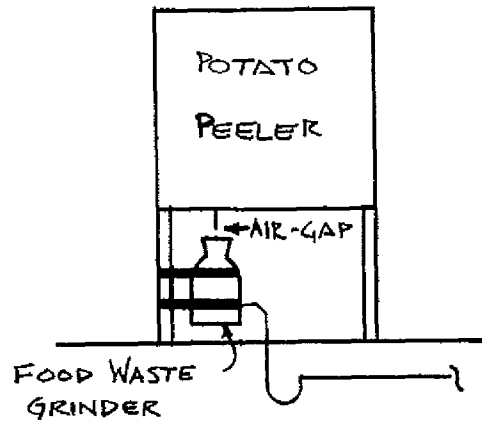
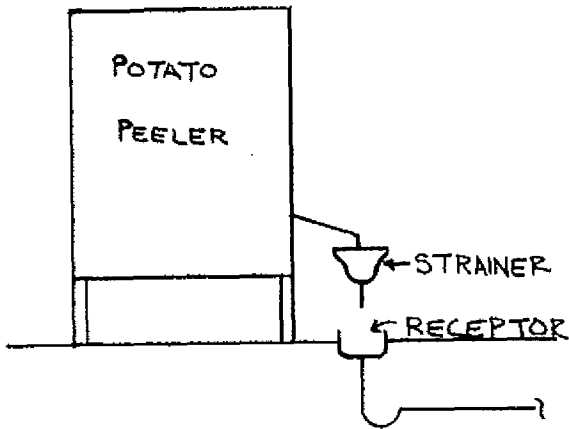

A-82.33 (9) (g) 5. MISCELLANEOUS FOOD HANDLING EQUIPMENT.

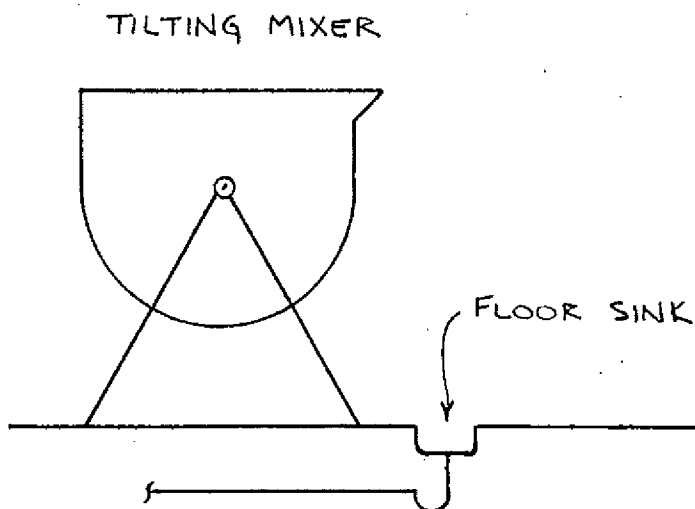
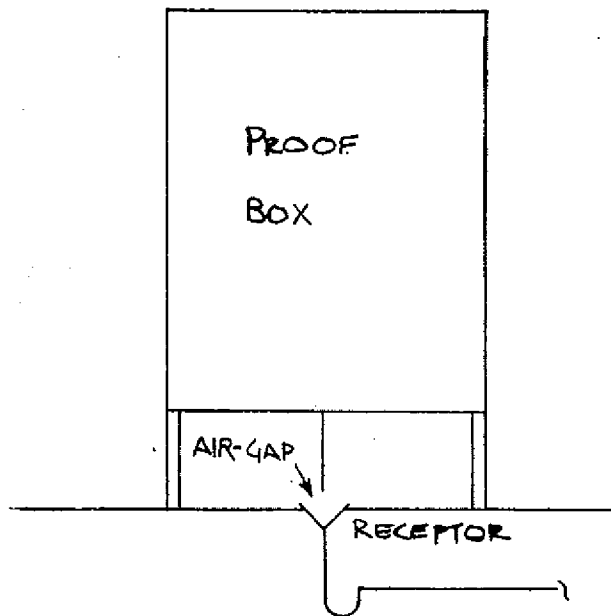

A-82.33 (9) (g) 5. MISCELLANEOUS FOOD HANDLING EQUIPMENT.

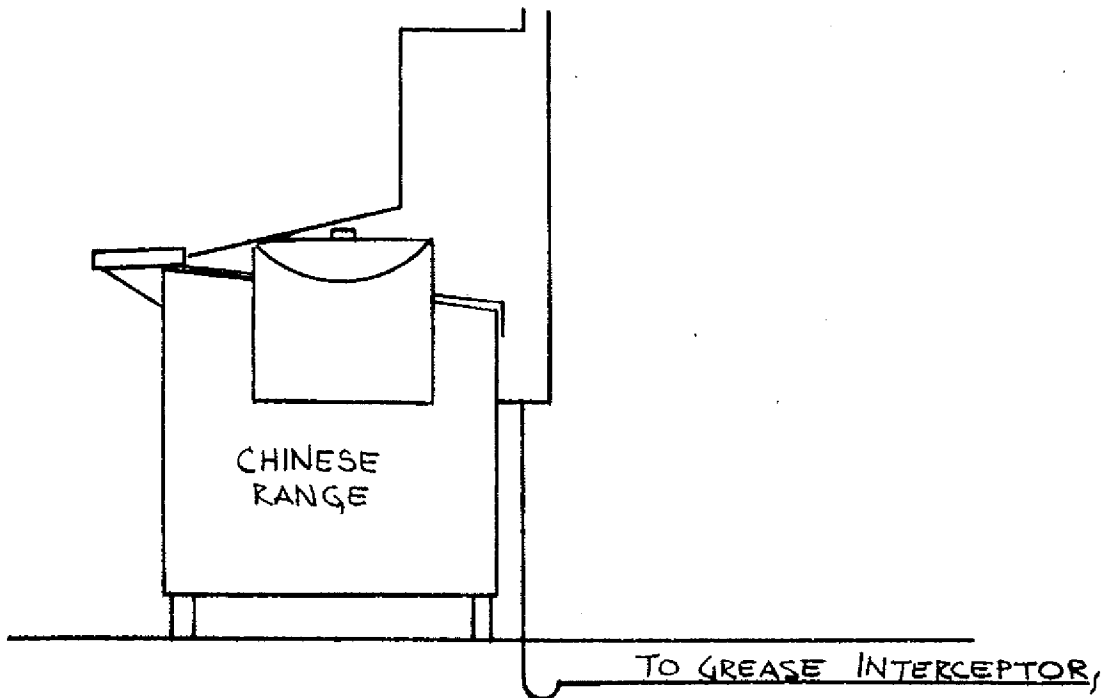
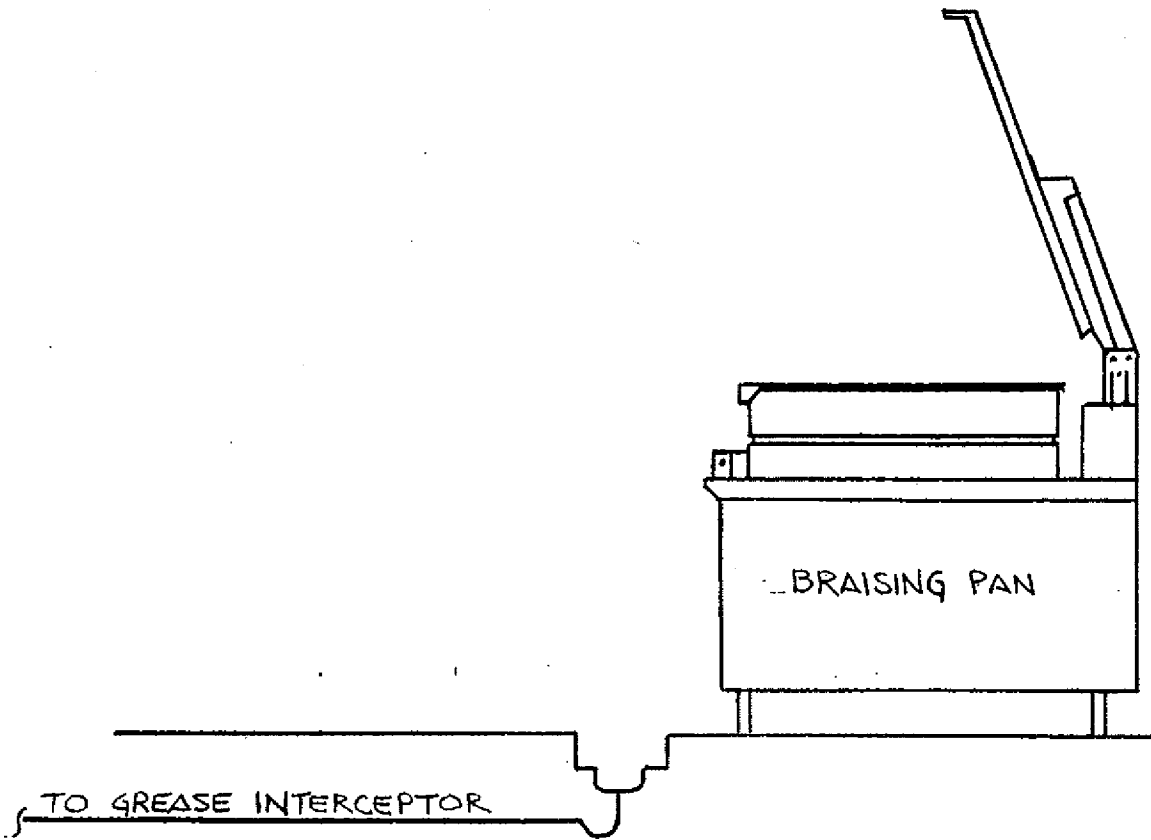

A-82.33 (9) (g) 5. MISCELLANEOUS FOOD HANDLING EQUIPMENT.

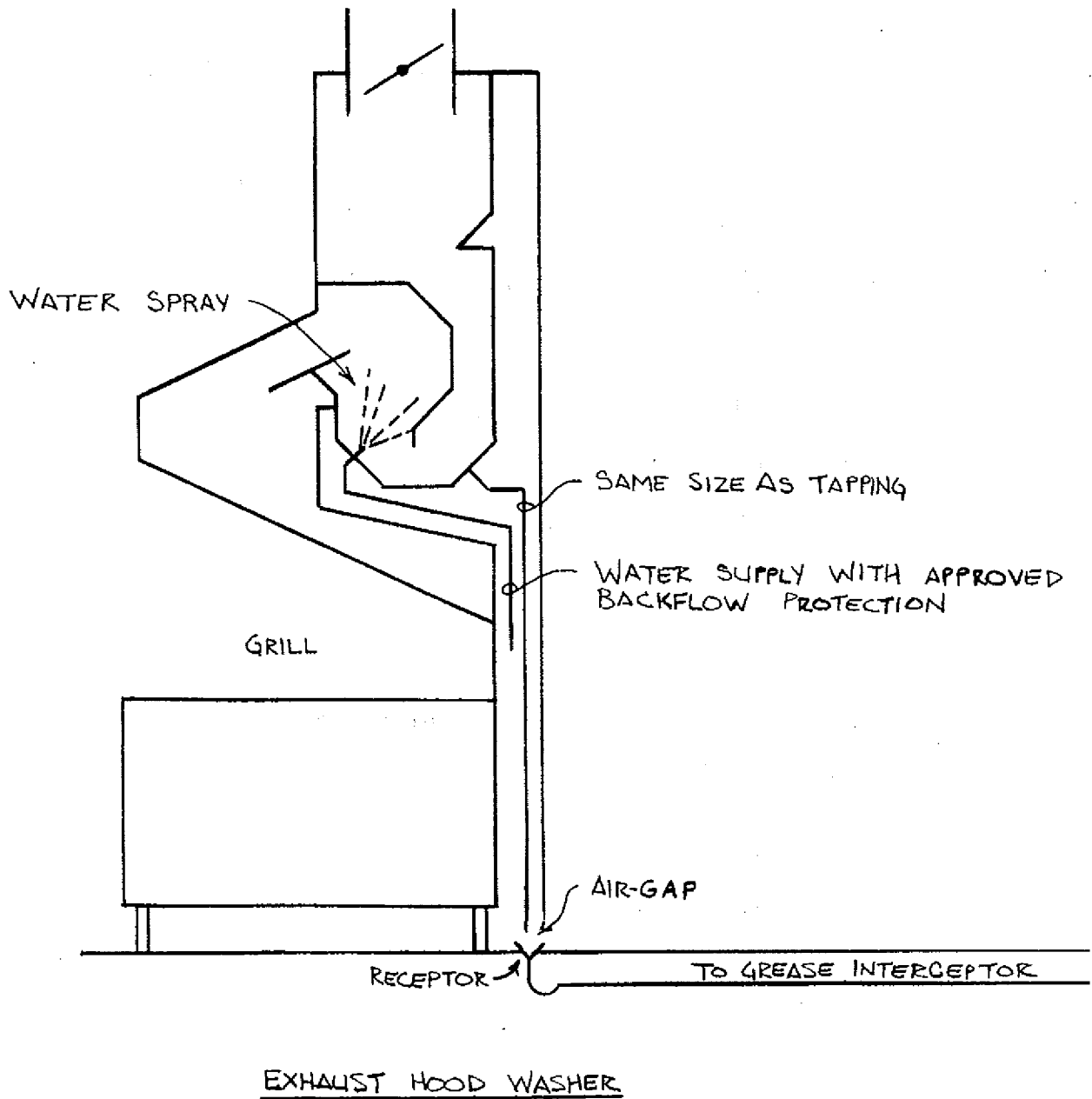

A-82.34 (4) (a) PUBLIC BUILDINGS.

GARAGE CATCH BASIN

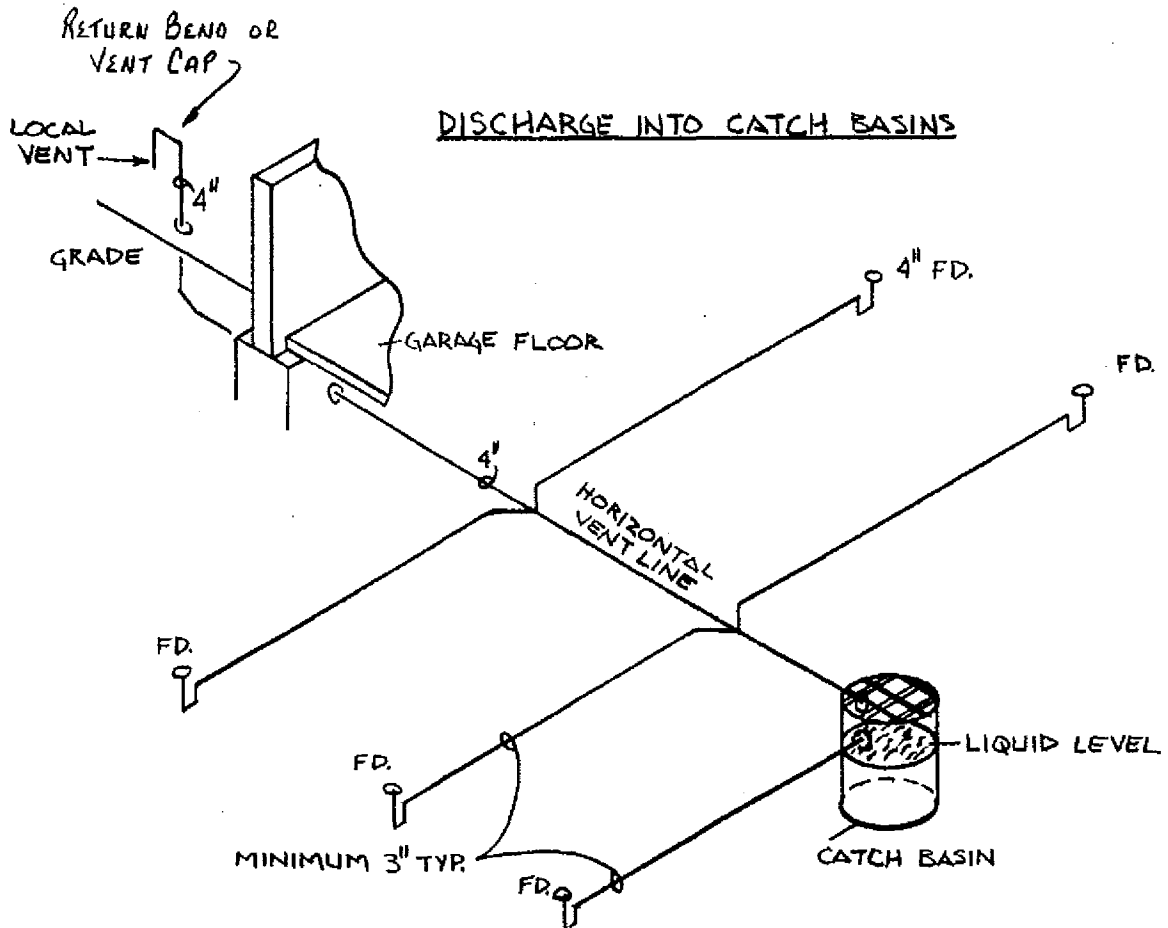
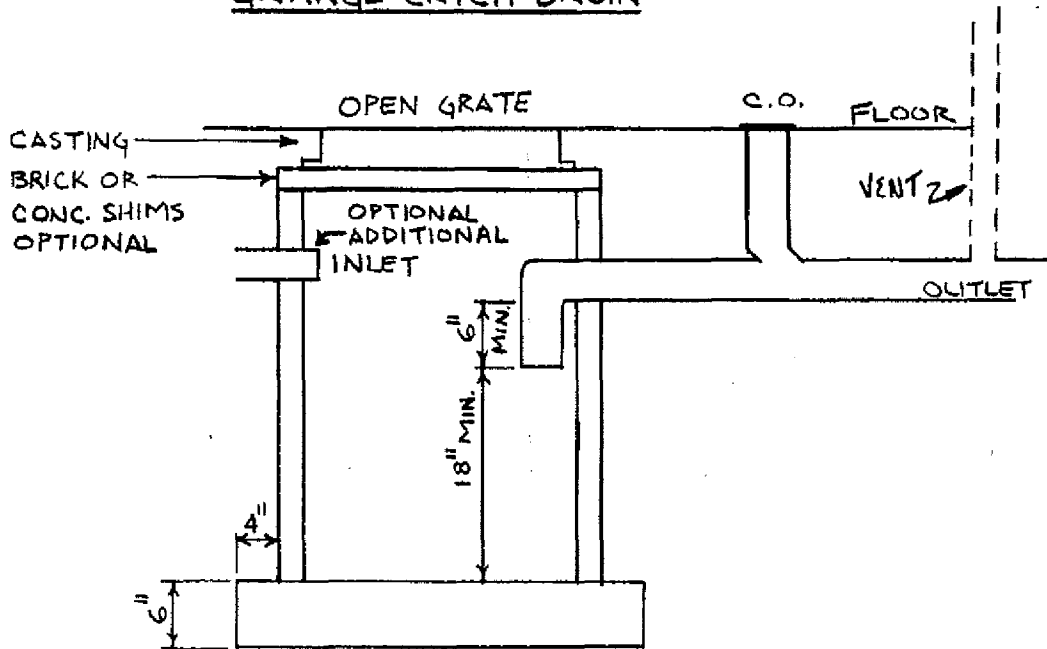

A-82.34 (4) (a) PUBLIC BUILDINGS.

Diameter of Catch Basin	Volume in cubic feet per foot of depth	Diameter of Catch Basin	Volume in cubic feet per foot of depth
36	7.1	45	11.1
37	7.5	46	11.6
38	7.9	47	12.1
39	8.3	48	12.6
40	8.7	54	15.9
41	9.2	60	19.7
42	9.7	66	23.8
43	10.1	72	28.3
44	10.6	84	38.6

A-82.34 (4) (a) PUBLIC BUILDINGS.

TRENCH DRAINS

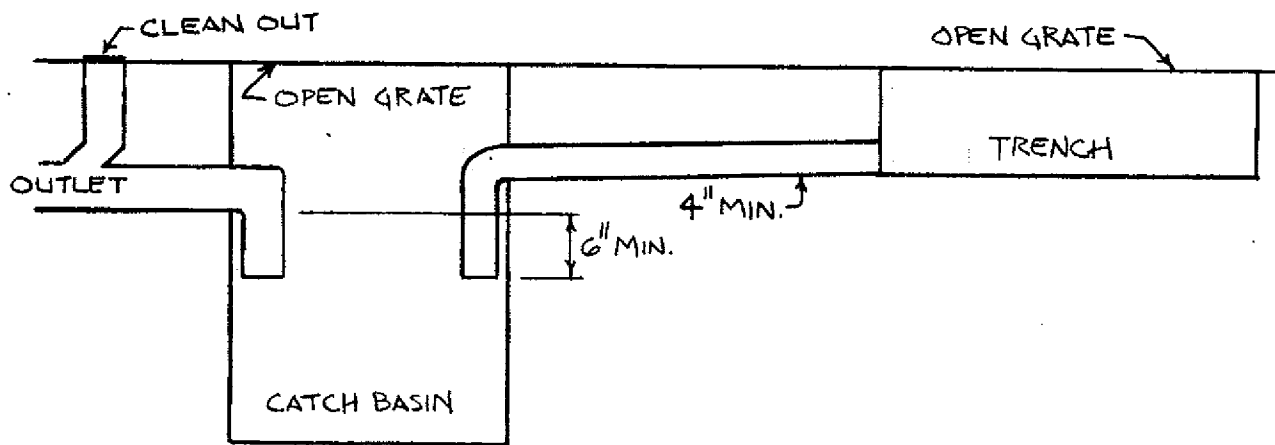

A-82.34 (4) (b) GARAGES FOR ONE- AND 2-FAMILY DWELLINGS.

TYPICAL FLOOR DRAIN WITH SOLID BOTTOM SEDIMENT BASKET

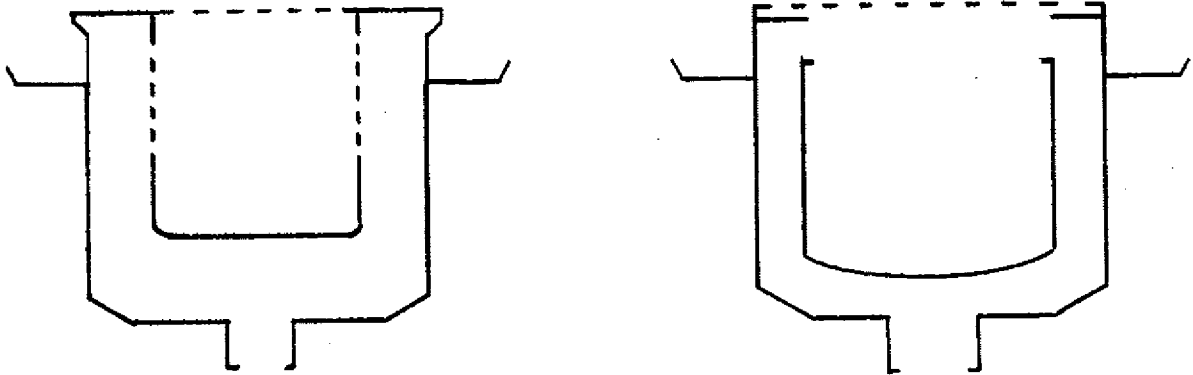

A-82.34 (5) (b) EXTERIOR GREASE INTERCEPTORS.

GREASE INTERCEPTOR MANHOLE LOCATION

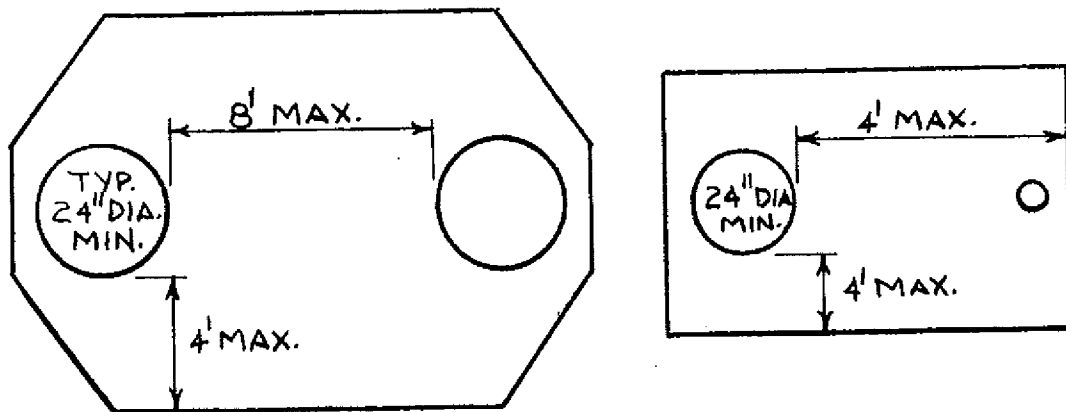

A-82.34 (5) (b) EXTERIOR GREASE INTERCEPTORS.

EXTERIOR GREASE INTERCEPTOR

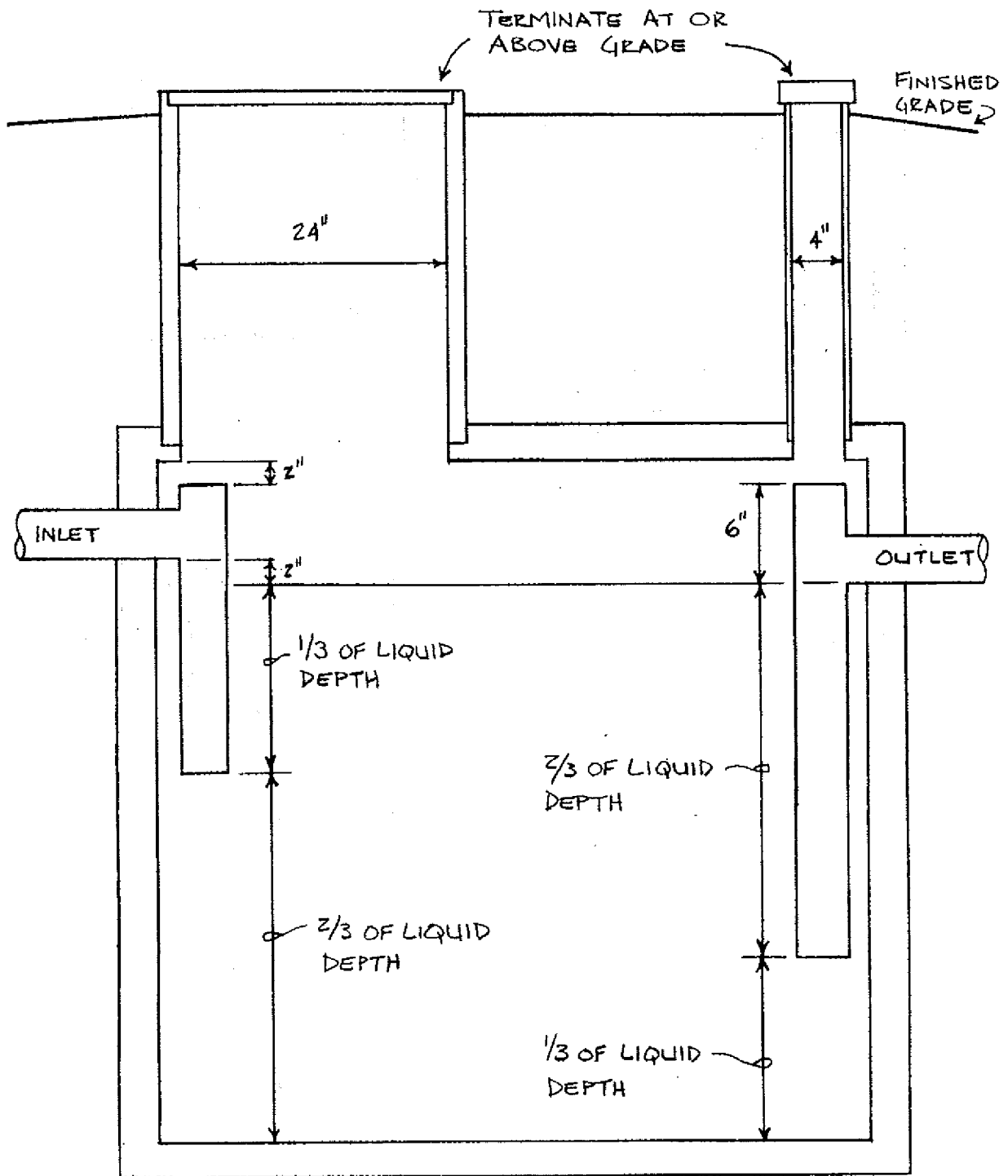

A-82.34 (5) (c) INTERIOR GREASE INTERCEPTORS.

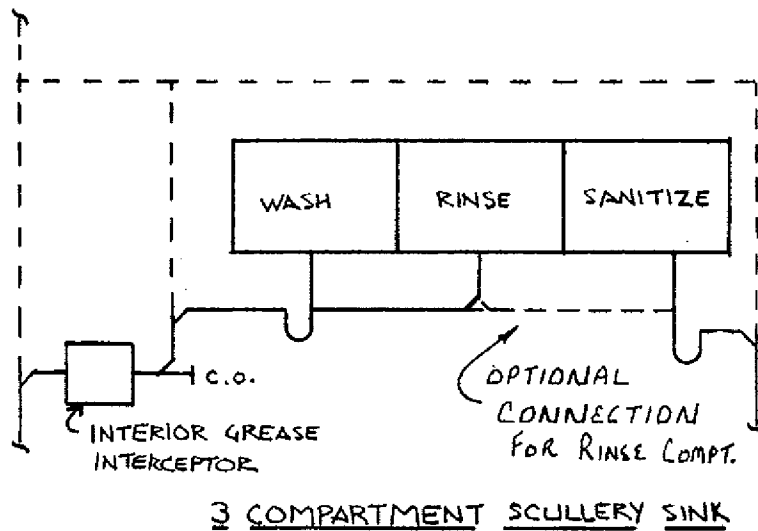
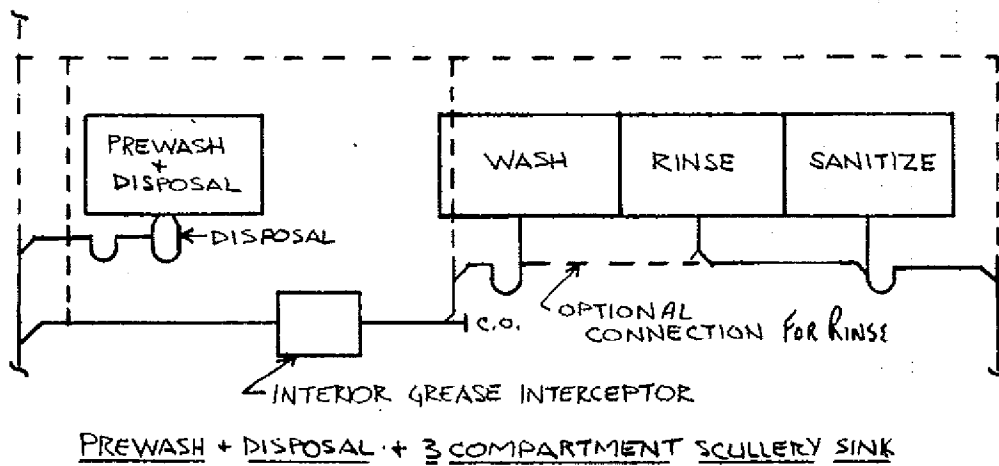
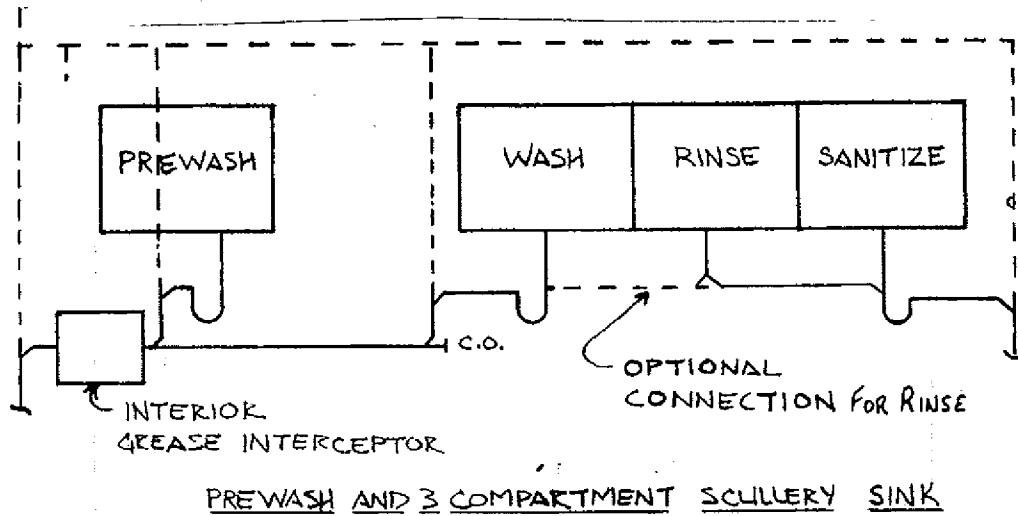

Note: Rinse and sanitize compartments and garbage disposals may discharge through interior grease interceptors.

A-82.34 (6) AUTOMATIC CAR WASHES.

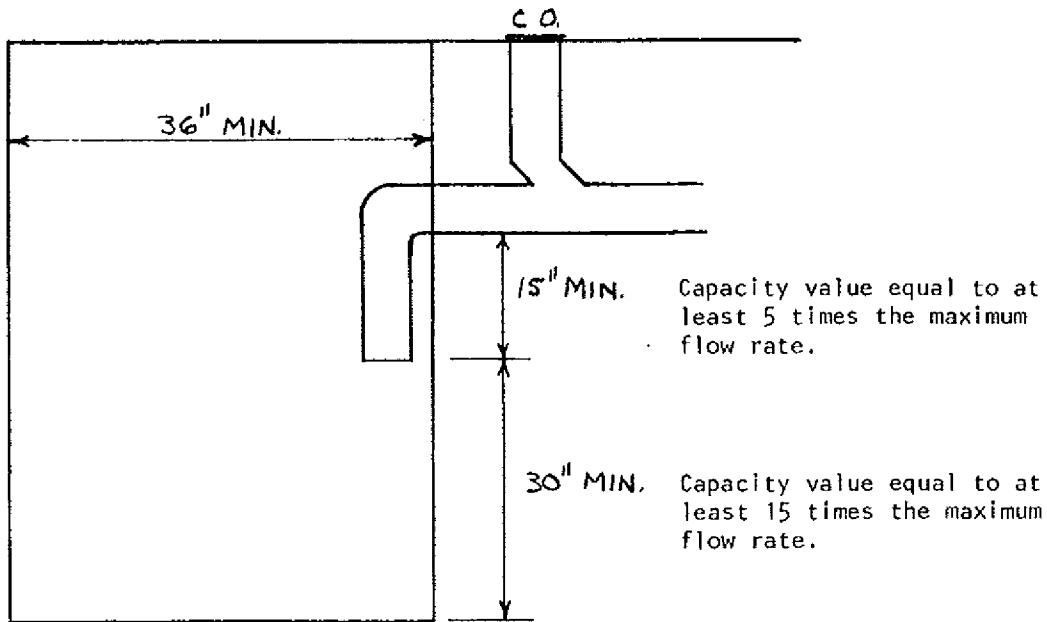

CAR WASH INTERCEPTOR WITH INVERT INSIDE OF BASIN

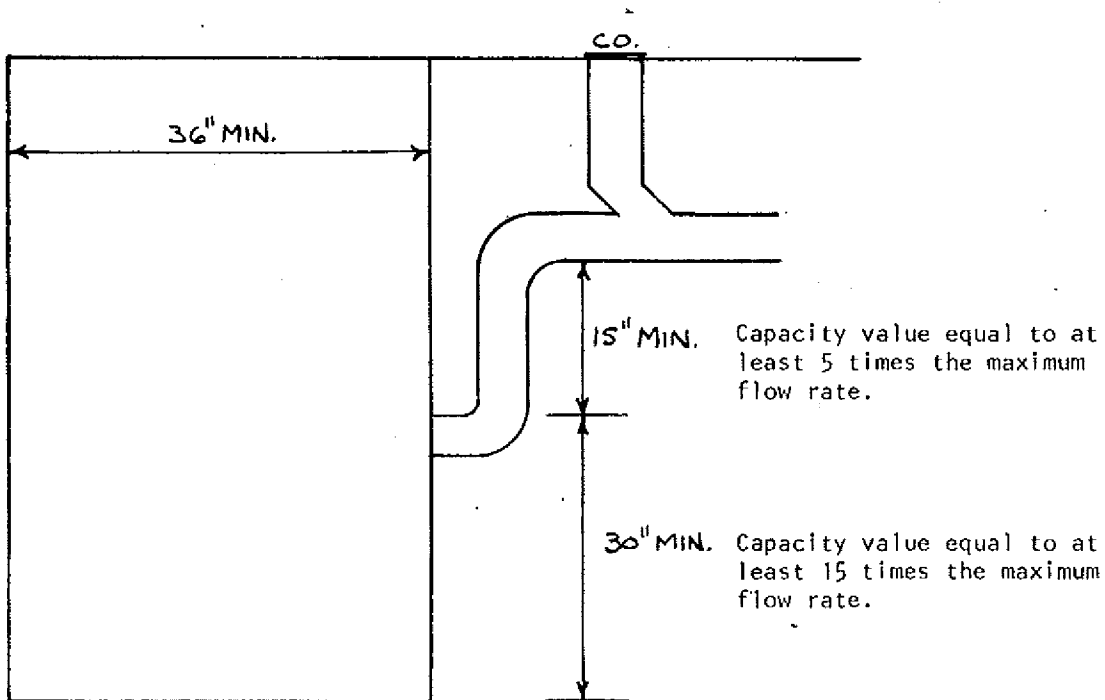

CAR WASH INTERCEPTOR WITH INVERT OUTSIDE OF BASIN

A-82.34 (7) COMMERCIAL LAUNDRIES.

TRENCH TYPE LAUNDRY INTERCEPTOR

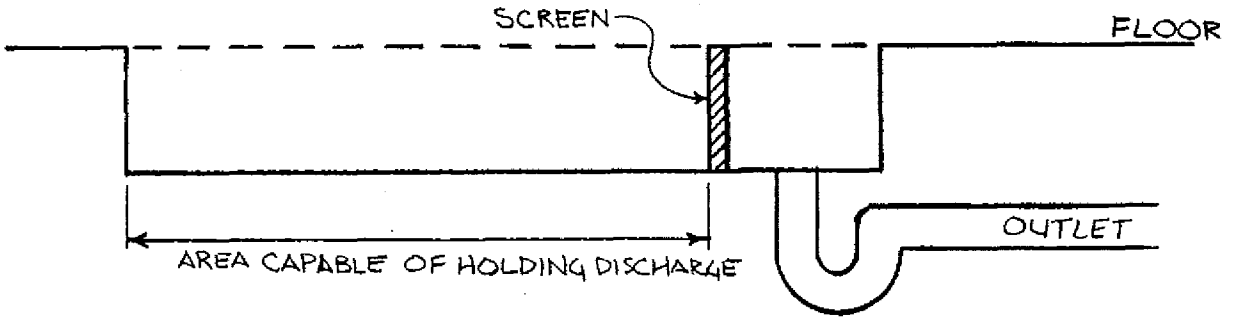

IN-LINE LAUNDRY INTERCEPTOR

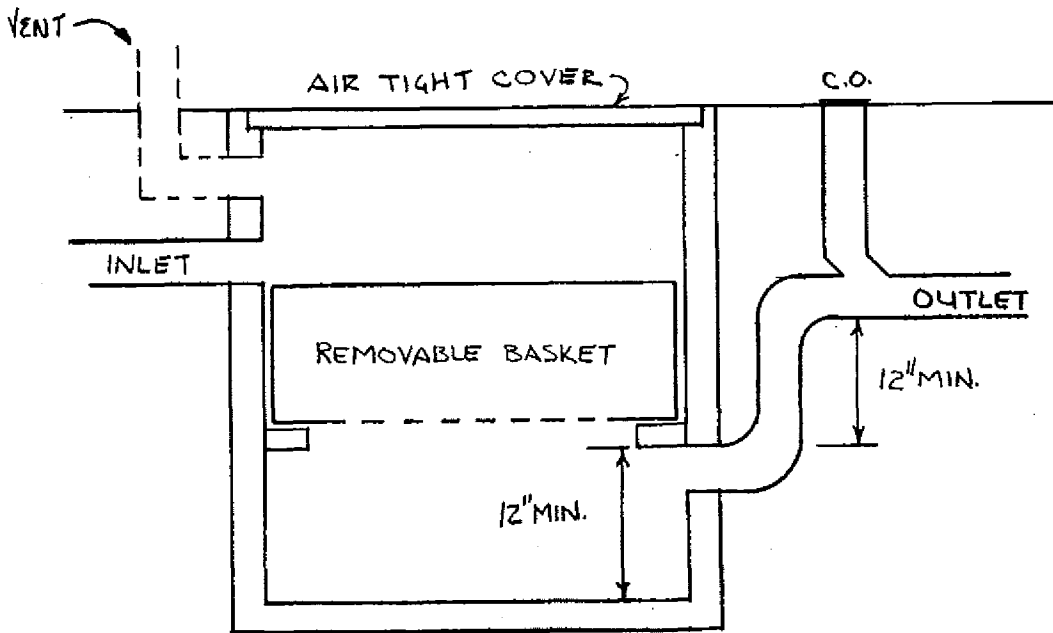

A-82.34 (8) OIL AND FLAMMABLE LIQUIDS.

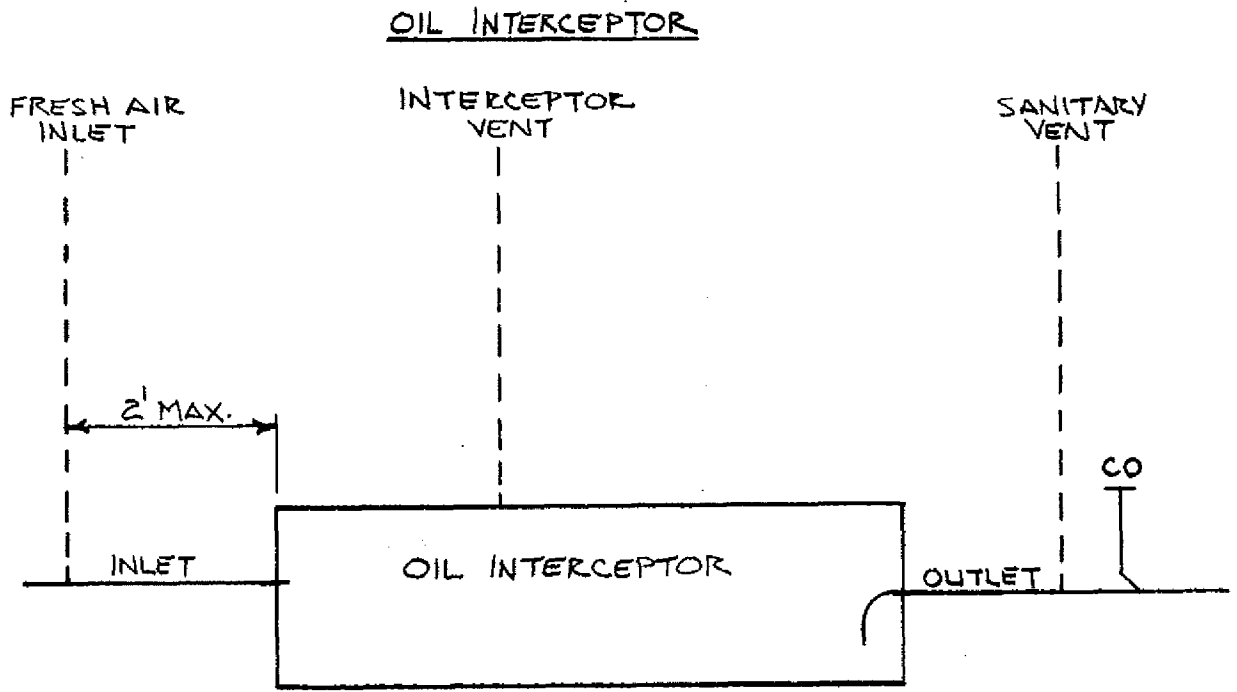

A-82.34 (13) PLASTER AND HEAVY SOLIDS TRAP TYPE INTERCEPTORS.

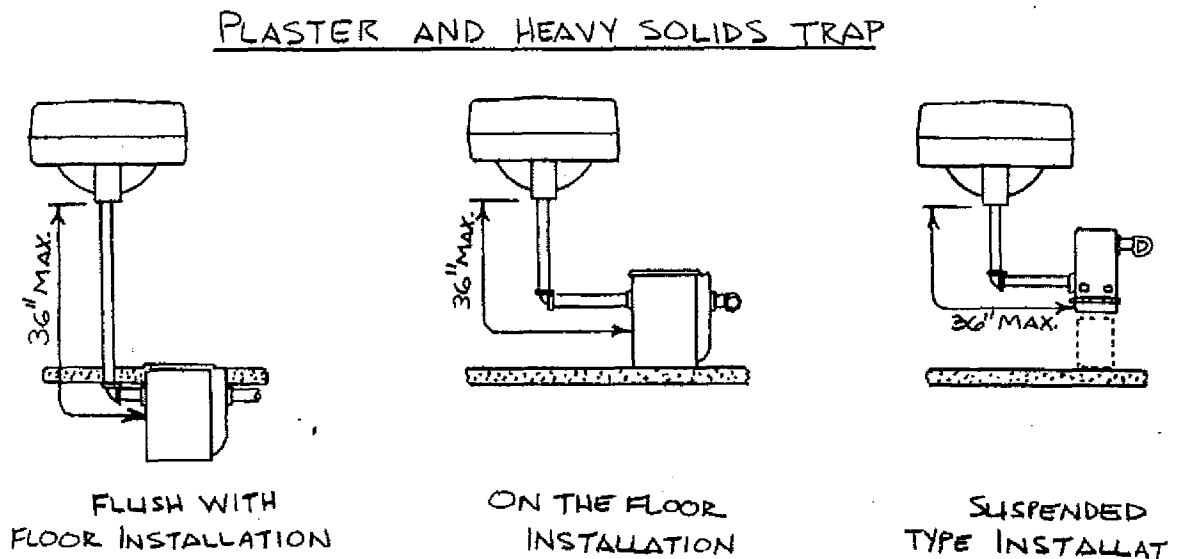

A-82.34 (14) CHEMICAL DILUTION AND NEUTRALIZING BASINS.

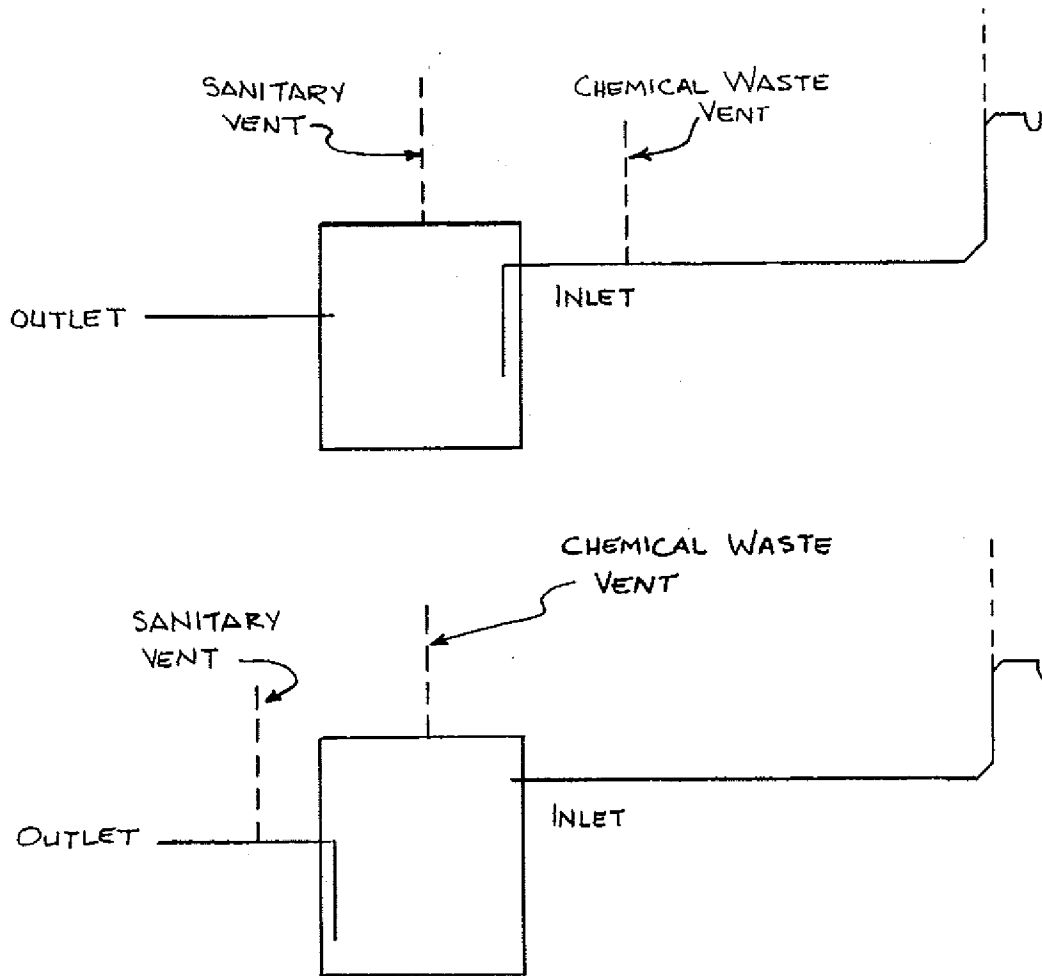

A-82.35 (3) CLEANOUTS SERVING HORIZONTAL DRAINS WITHIN OR UNDER A BUILDING.

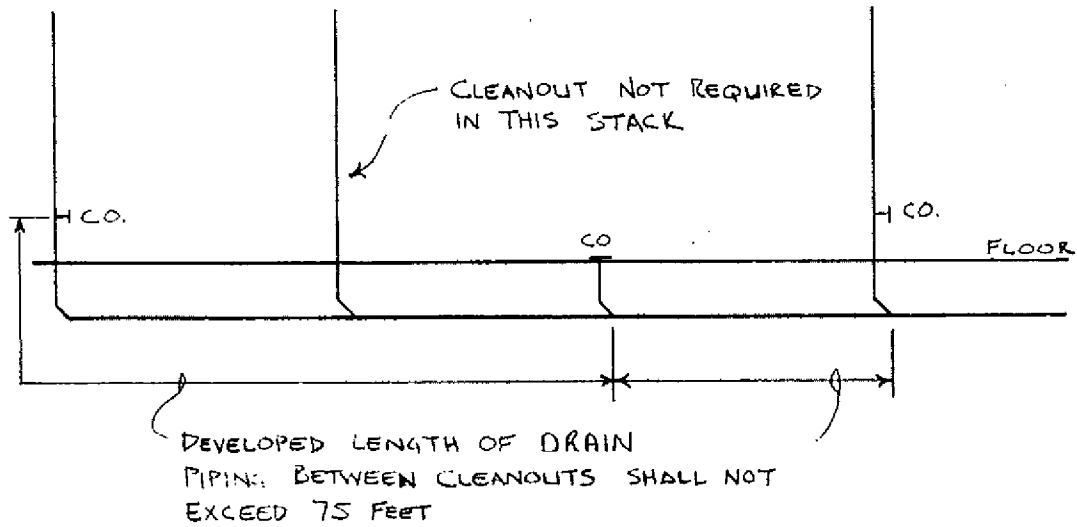

A-82.35 (3) CLEANOUTS SERVING HORIZONTAL DRAINS.

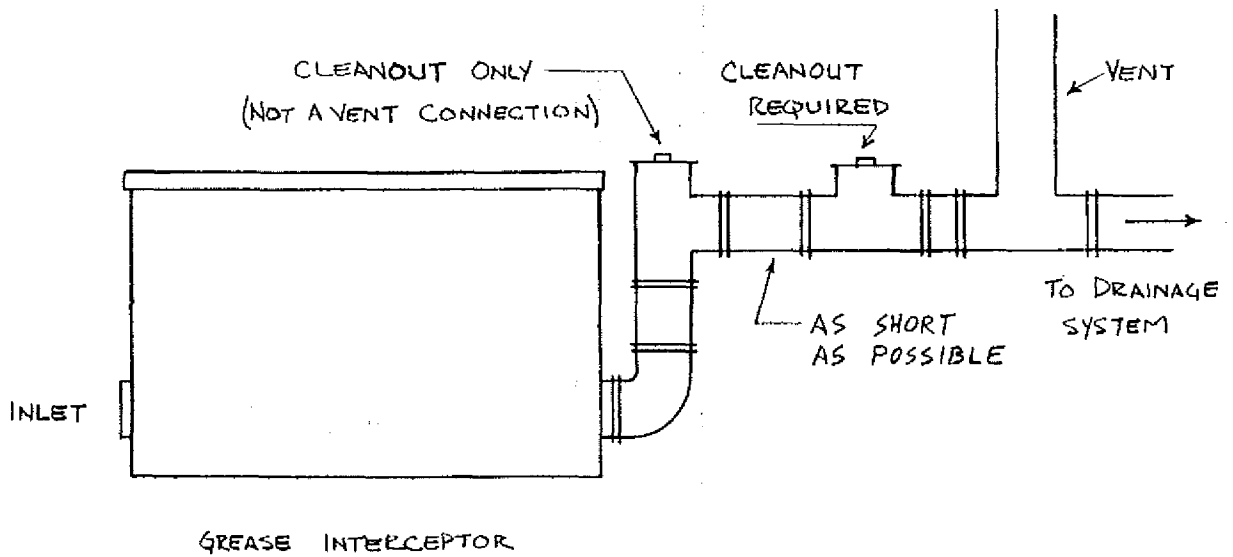
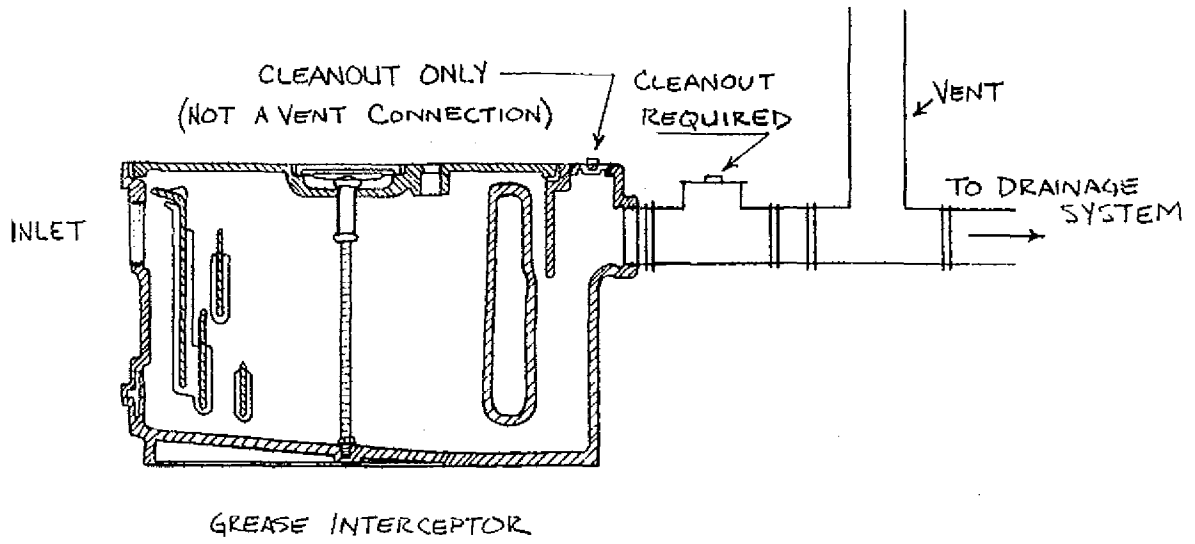

A-82.35 (5) (a) CLEANOUT EXTENSION TO GRADE.

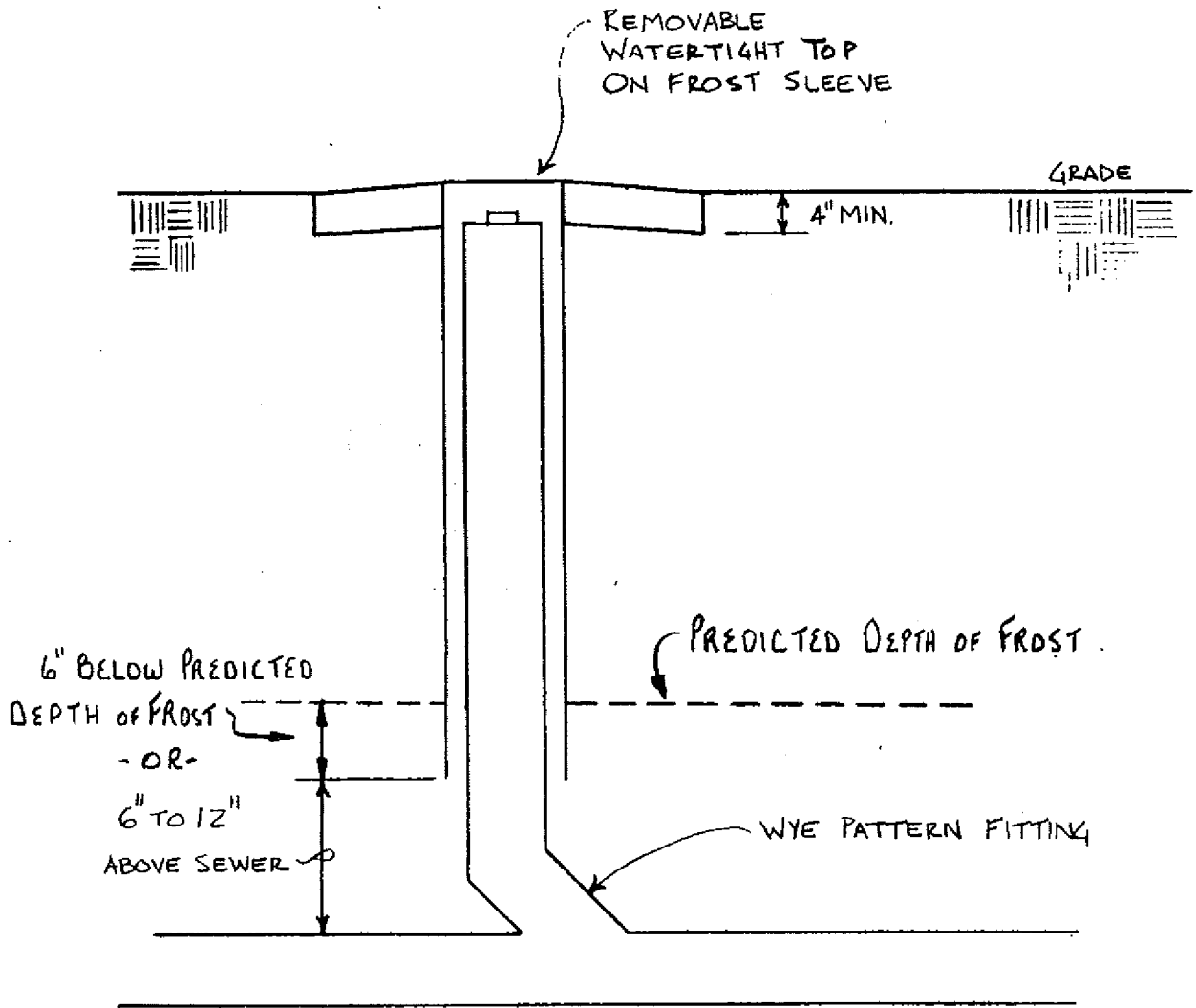
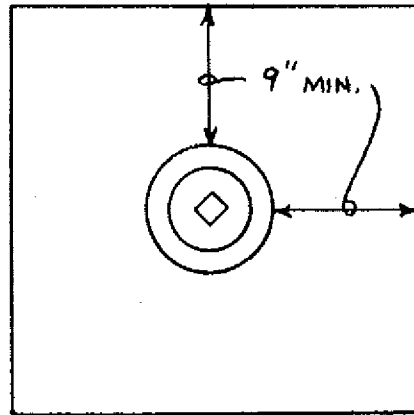

A-82.35 (8) MANHOLES.

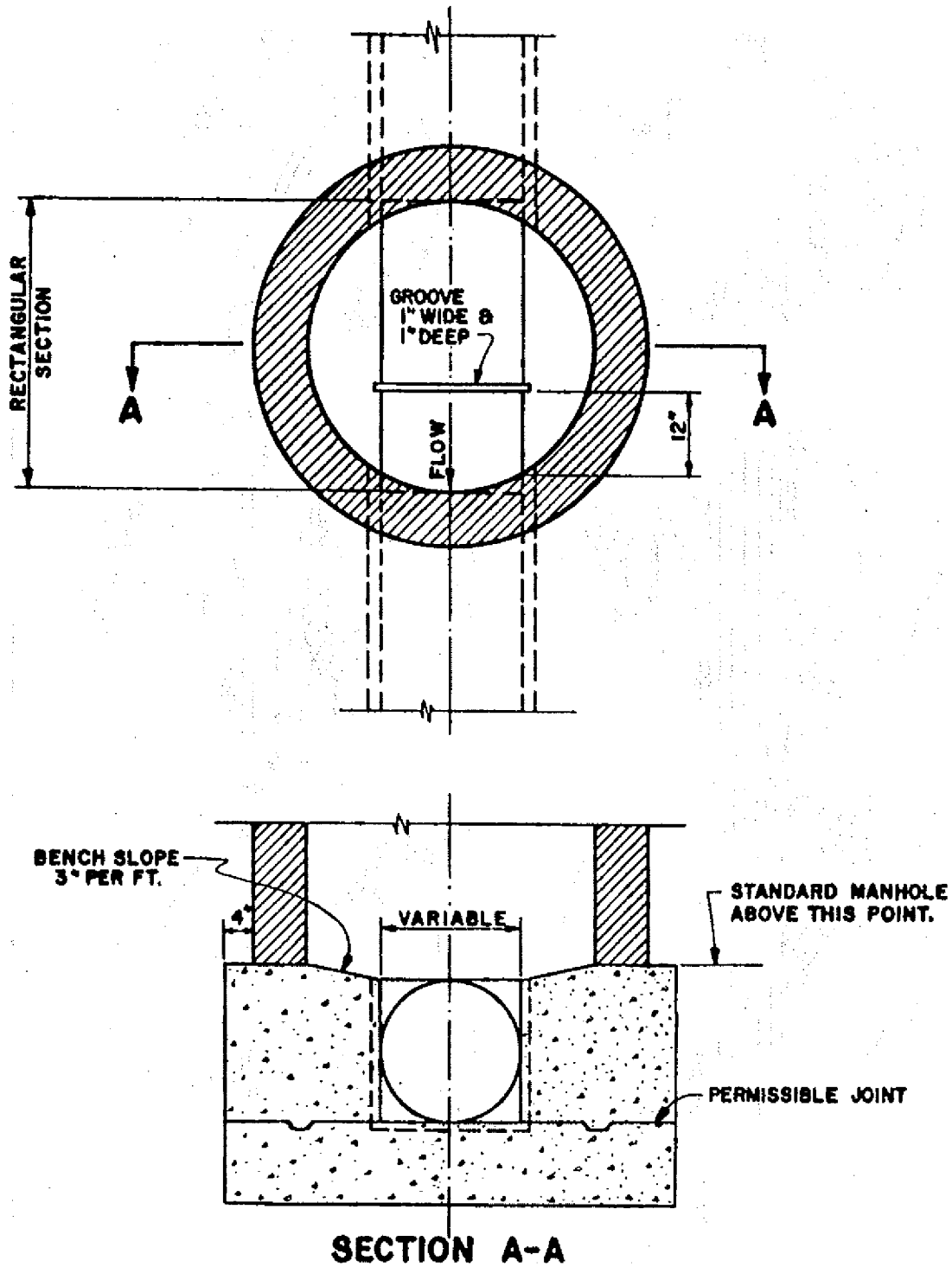

DETAIL OF SAMPLING MANHOLE

A-82.35 (8) MANHOLES.

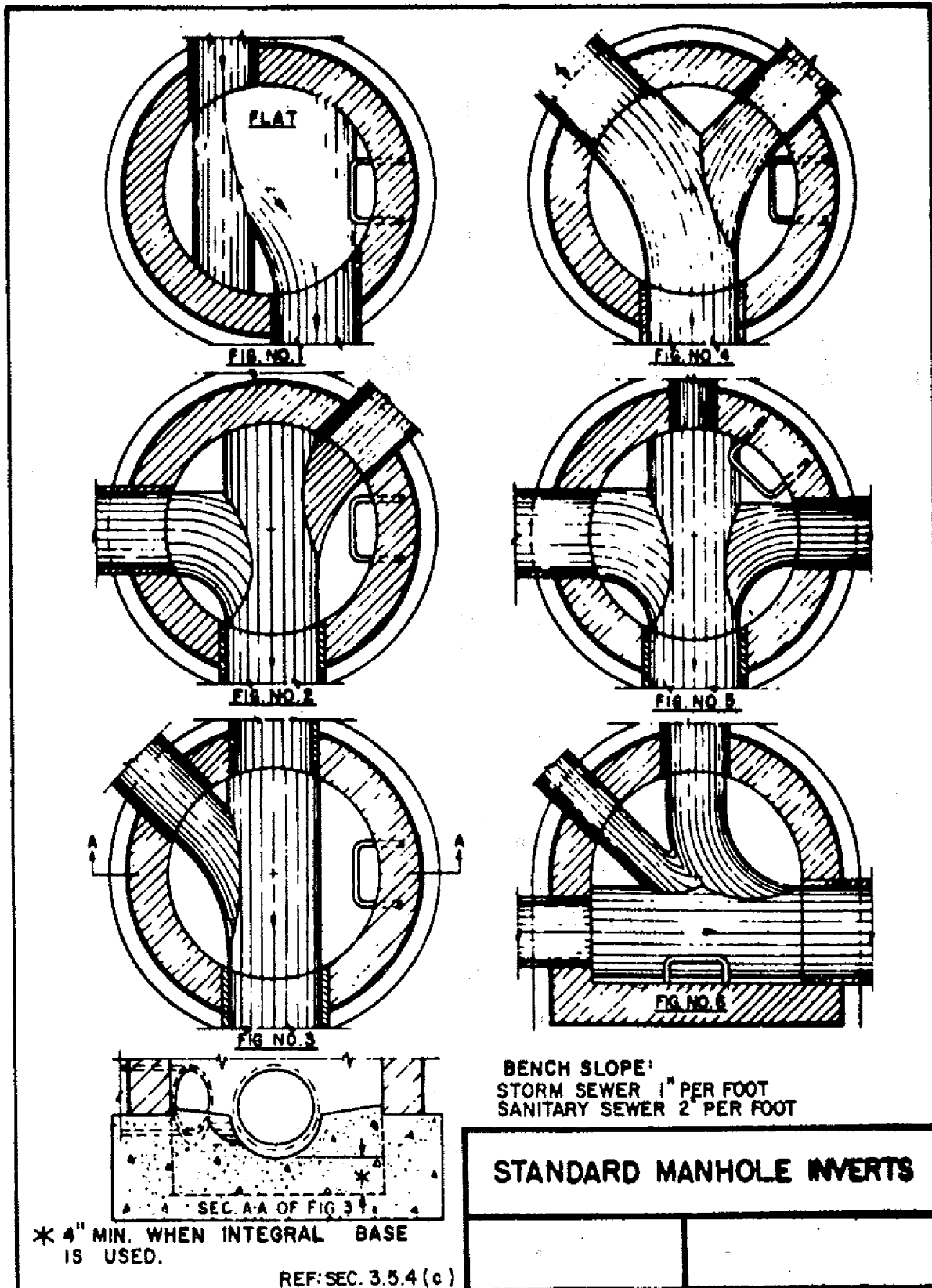

A-82.35 (8) MANHOLES.

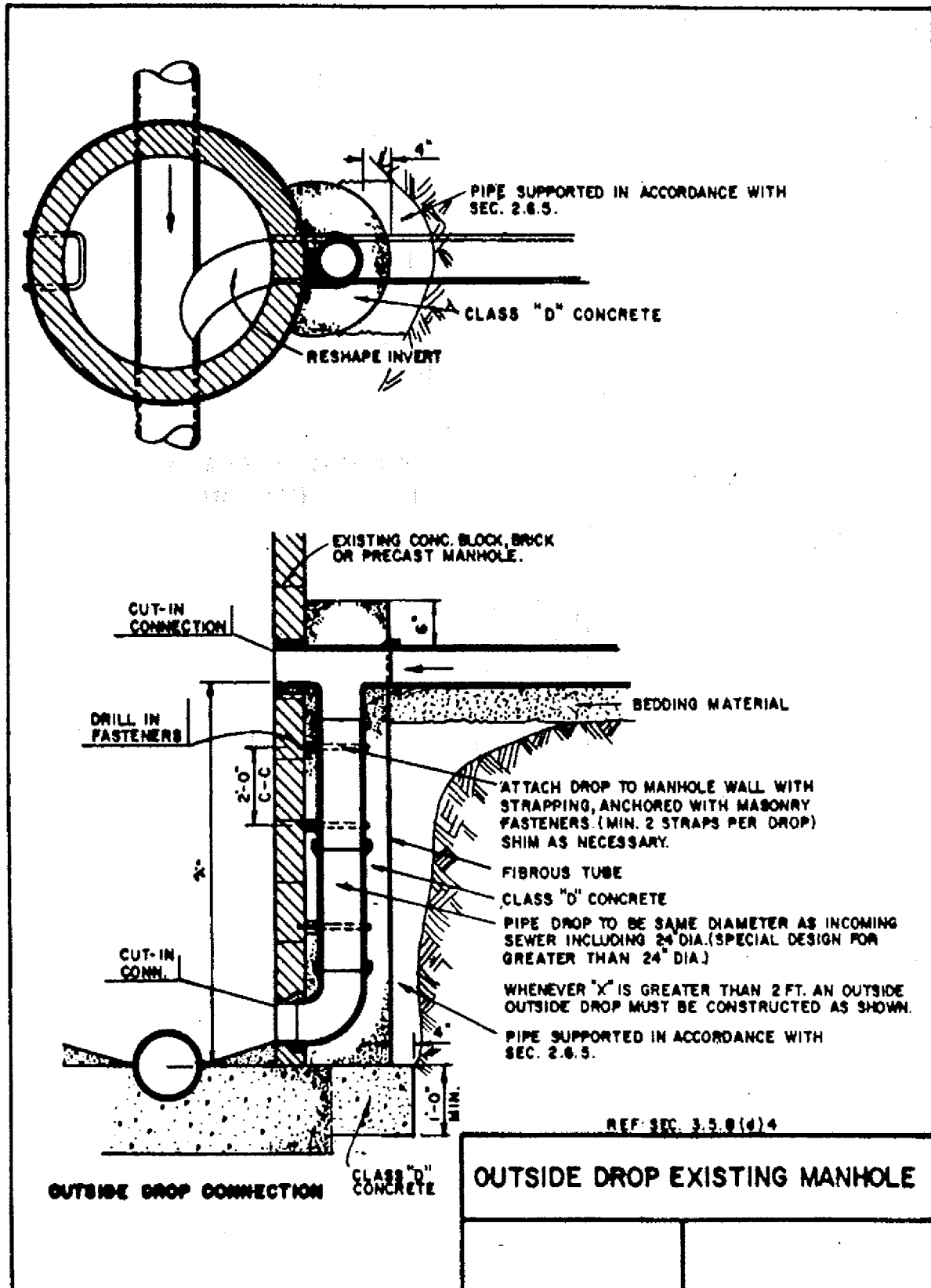

A-82.36 (17) AREA DRAIN INLETS.

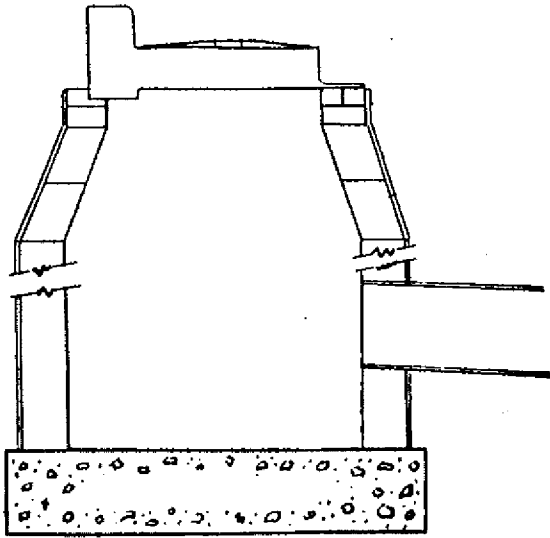

STANDARD STORM WATER
CATCH BASIN (MASONRY)

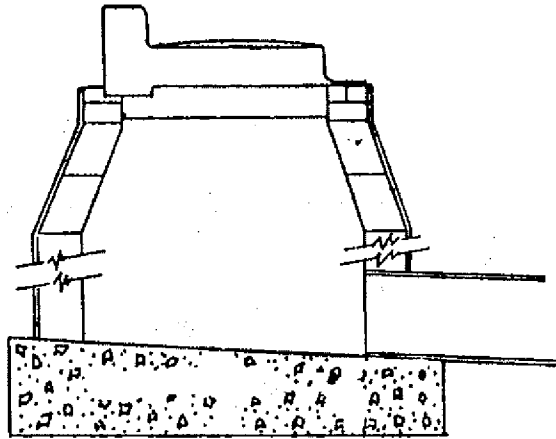

STANDARD STORM WATER
INLET (MASONRY)

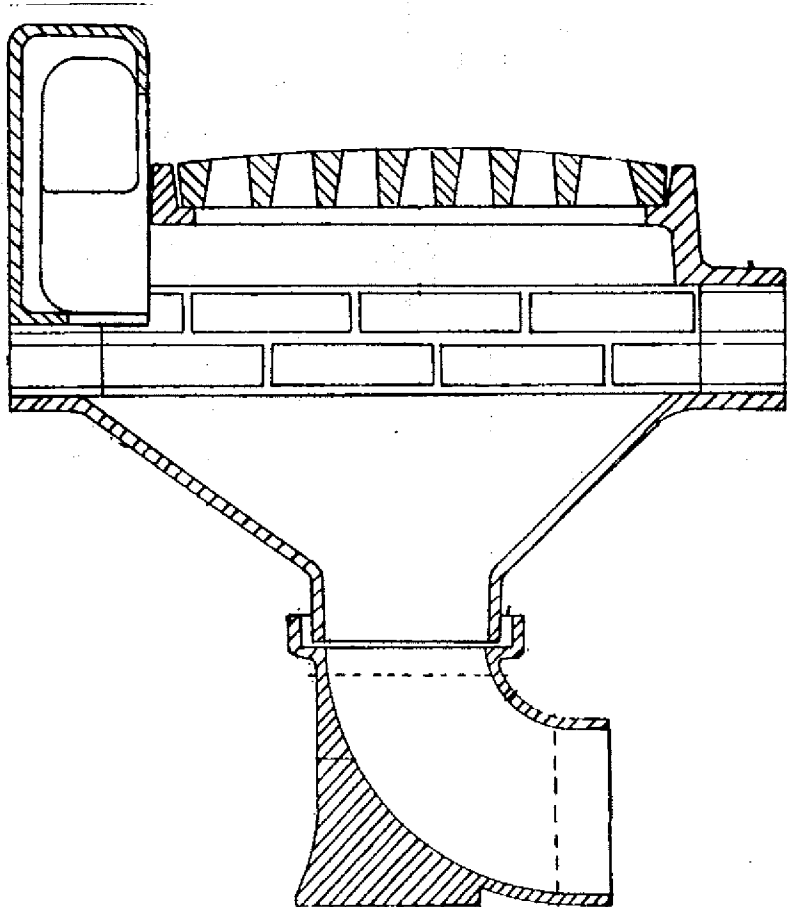

CAST IRON STORM
WATER INLET

A-82.40 (4) CONTROL VALVES.

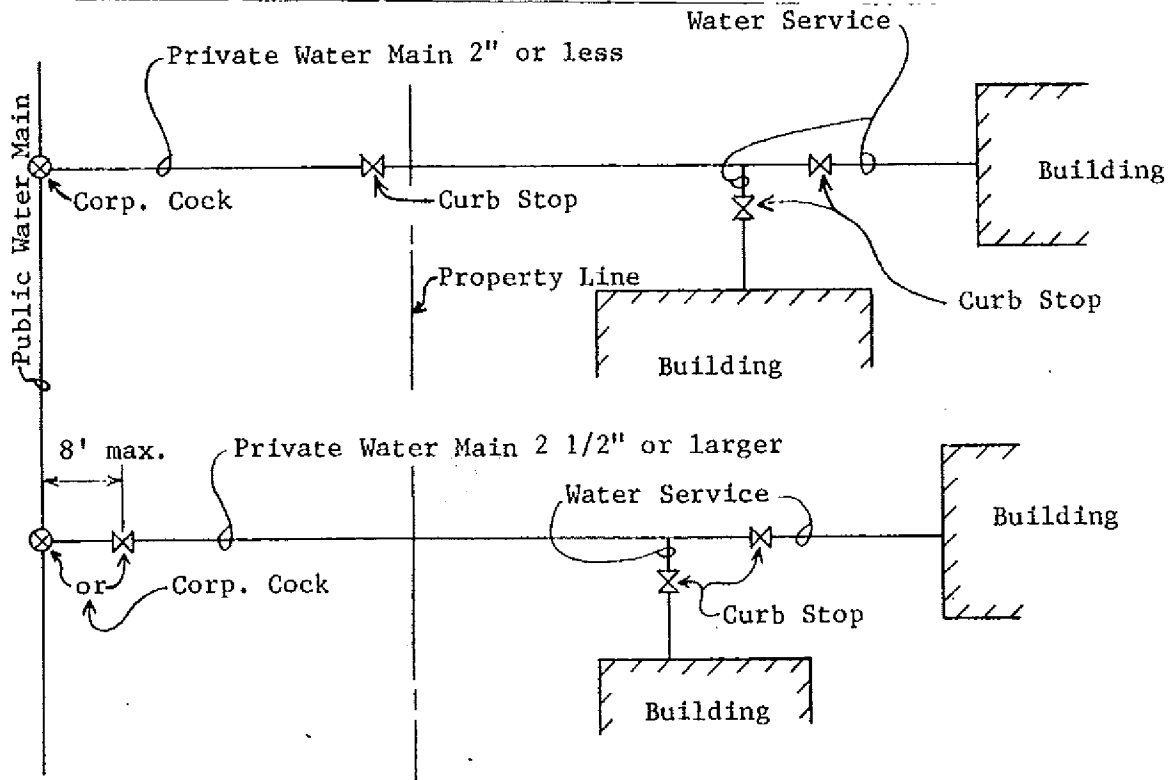

A-82.40 (4) (b) WATER SERVICES.

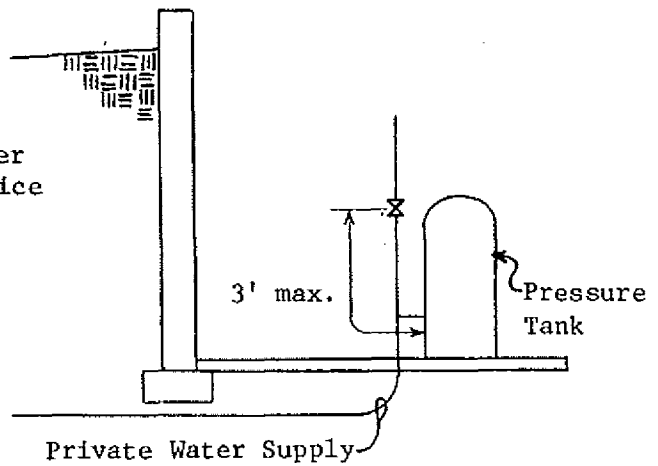
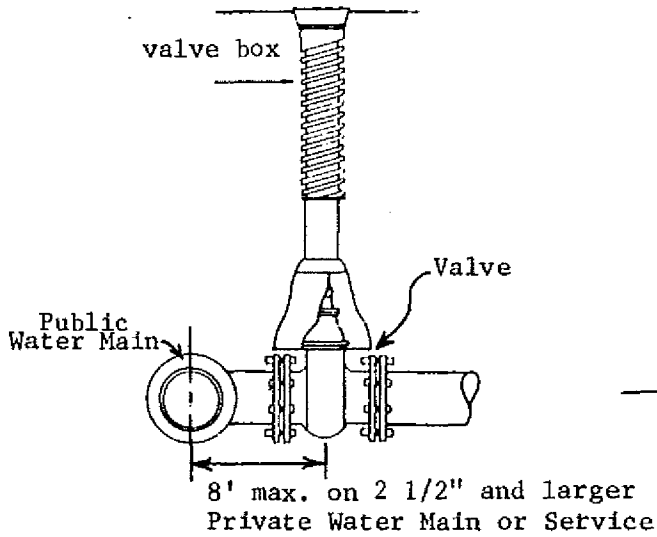
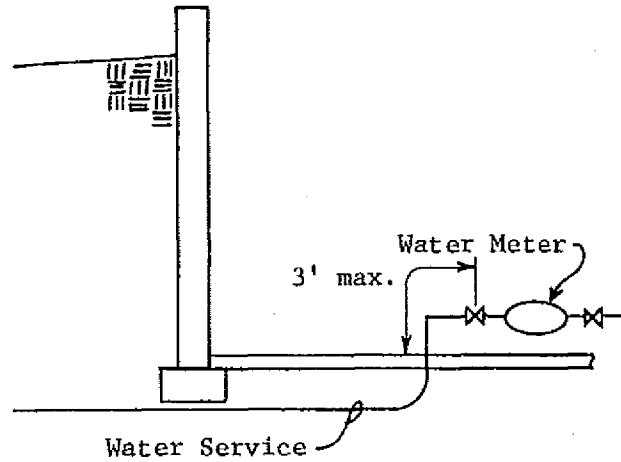
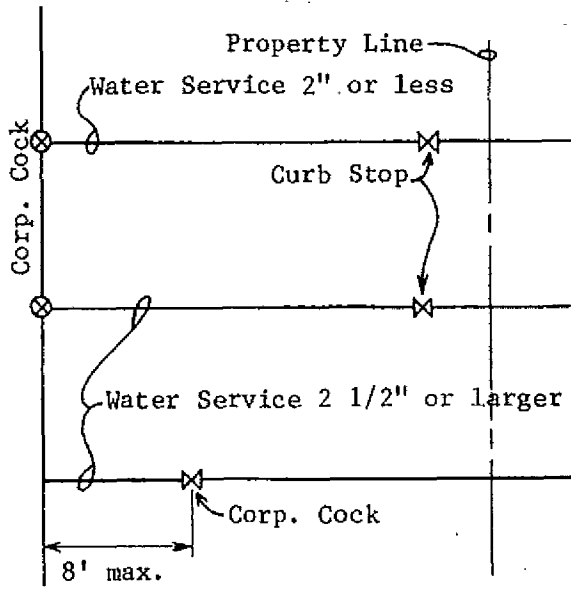

A-82.40 (5) STORAGE TANK AND PIPING INSULATION. The following is a reprint of section Comm 63.29 (1) and (2).

Comm 63.29 Insulation, materials and construction. (1) GENERAL. Insulation required by subs. (2) and (3) shall be suitably protected from damage.

Note: Insulation should be installed in accordance with practices acceptable to the department such as MICA Commercial and Industrial Insulation Standards.

(2) **PIPING INSULATION.** Except as provided in pars. (a) to (c), recirculating plumbing system piping, plumbing piping in the first 8 feet from storage tanks for noncirculating systems, any piping served by a self-regulating electric heating cable, HVAC system piping, and related HVAC fluid conveying conduit, such as heat exchanger bodies, shall be thermally insulated in accordance with Table 63.29-1 or equivalent. The following piping or conduit is exempted from this subsection:

(a) Factory-installed piping or conduit within HVAC equipment tested and rated in accordance with s. Comm 63.20;

(b) Piping or conduit for which no insulation is specified in Table 63.29-1.

(c) Where it can be shown that the heat gain or heat loss to or from piping or conduit without insulation will not increase building energy use.

Note: For equivalent insulation levels using alternative insulation types, the calculation procedure specified in A63.29 of Appendix A is acceptable to the department.

Table 63.29-1

Plumbing and HVAC Piping Minimum Insulation (in.)^{a,b}

Fluid Operating Temperature Range, °F	Nominal Pipe Diameter (in.)					Insulation Conductivity	
	1 and Less	1-1 1/4 to 2	2 1/2 to 4	5 and 6	8 and up	Conductivity Range Btu·in./(h·ft ² ·°F)	Mean Rating Temperature °F
Hot Systems (Steam, Steam Condensate, and Hot Water)							
Above 350	2.5	2.5	3.0	3.5	3.5	0.32 - 0.34	250
251 - 350	2.0	2.5	2.5	3.5	3.5	0.29 - 0.31	200
201 - 250	1.5	1.5	2.0	2.0	3.5	0.27 - 0.30	150
141 - 200	1.5	1.5	1.5	1.5	1.5	0.25 - 0.29	125
105 - 140	1.0	1.0	1.0	1.5	1.5	0.24 - 0.28	100
80 - 104	0.5	0.5	0.5	1.0	1.0	0.24 - 0.28	100
Cold Systems (Chilled Water, Brine, and Refrigerant)^c							
40 - 55	0.5	0.75	1.0	1.0	1.0	0.23 - 0.27	75
Below 40	1.0	1.5	1.5	1.5	1.5	0.23 - 0.27	75

^a For minimum thicknesses of alternative insulation types, see Appendix A.

^b Plumbing piping systems without a heat trap to prevent circulation due to natural convection shall be considered circulating systems.

^c The required minimum thicknesses do not consider water vapor transmission and condensation. Additional insulation, vapor retarders, or both, may be required to limit water vapor transmission and condensation.

A-82.40 (7) (a) METHODOLOGY.

Where equipment such as an instantaneous or tankless water heater, water treatment device, water meter, and backflow preventer is provided in the design, the friction loss in such equipment, corresponding to the GPM demand, should be determined from the manufacturer or other reliable source.

Where a direct fired pressurized tank type water heater is provided in the design, the friction loss for such equipment can be assumed as part of the pressure losses due to flow through piping, fittings, valves and other plumbing appurtenances when the developed length of piping is multiplied by 1.5.

The pressure losses due to flow friction through displacement type cold-water meters may be calculated from Graph A-82.40 (7)-1.

Graph A-82.40 (7) - 1
PRESSURE LOSS IN COLD-WATER METERS, DISPLACEMENT TYPE

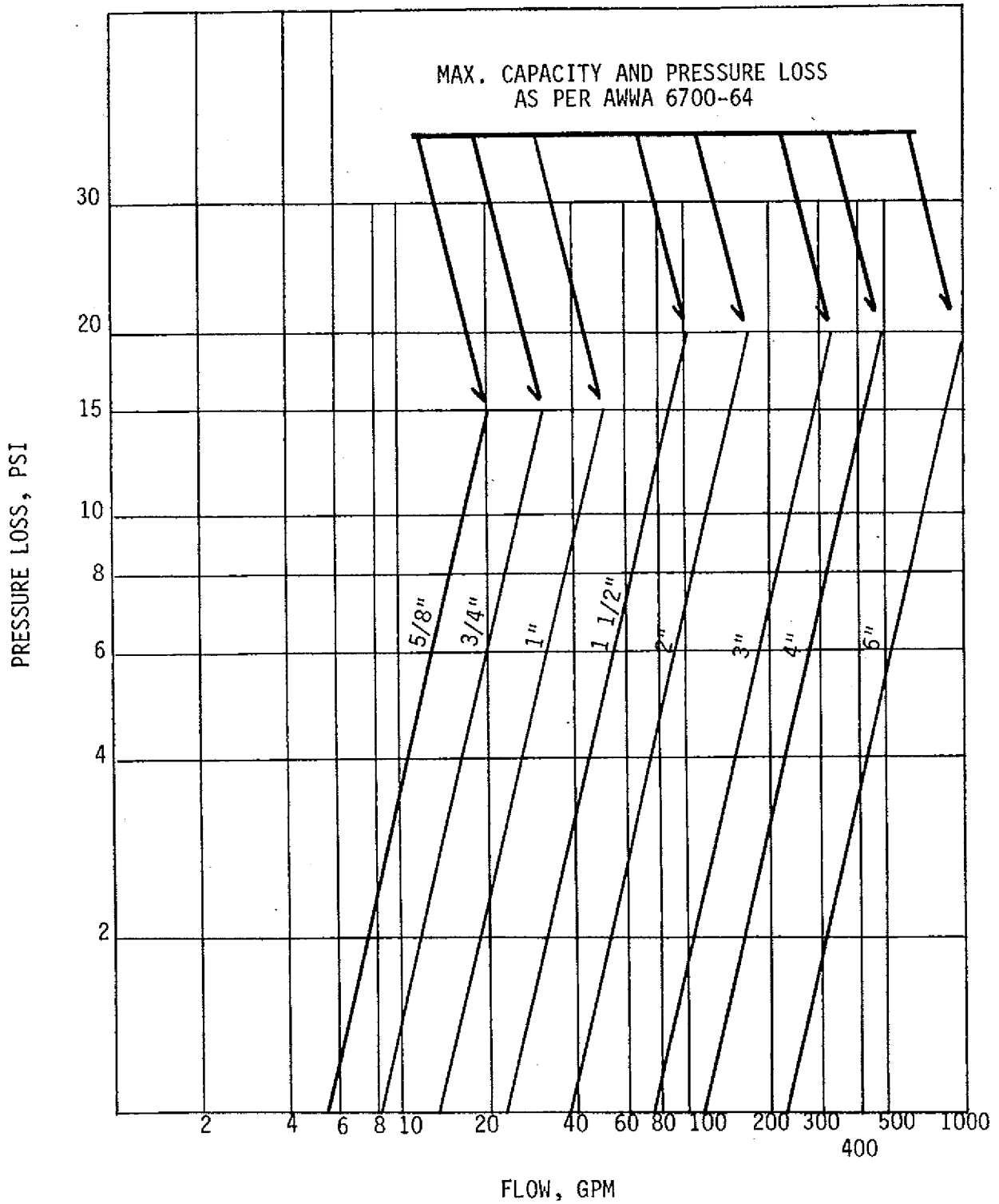

A-82.40 (7) (b) PRIVATE WATER MAINS AND WATER SERVICES.

Graphs A-82.40 (7)-2 to A-82.40 (7)-6 may be used to size private water mains and water services.

Graph A-82.40 (7)-2

Pressure losses due to flow friction

Material: Copper Tube-Type K, ASTM B88

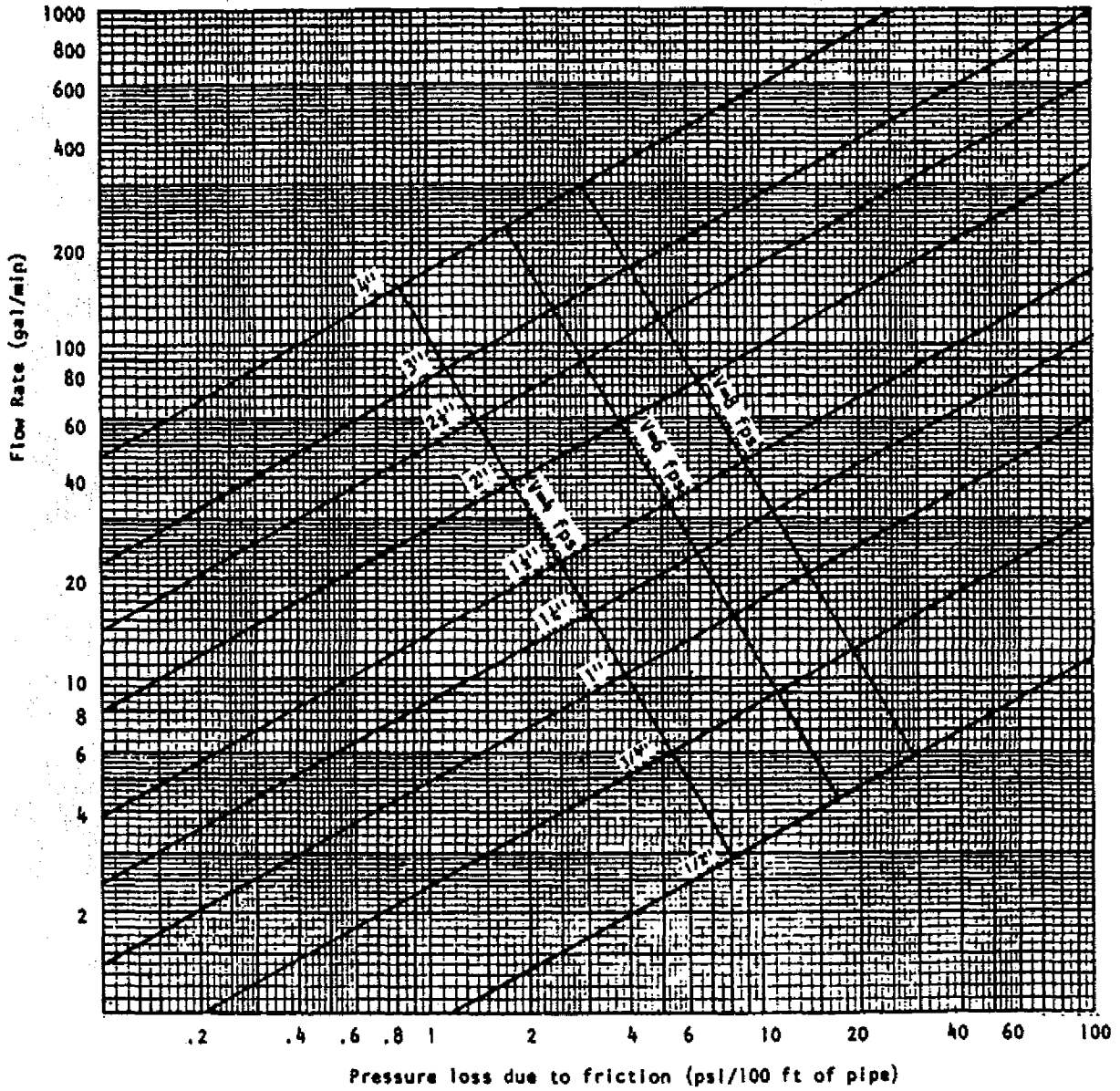

Graph A-82.40 (7)-3
Pressure losses due to flow friction
Material: Copper Tube-Type L, ASTM B88

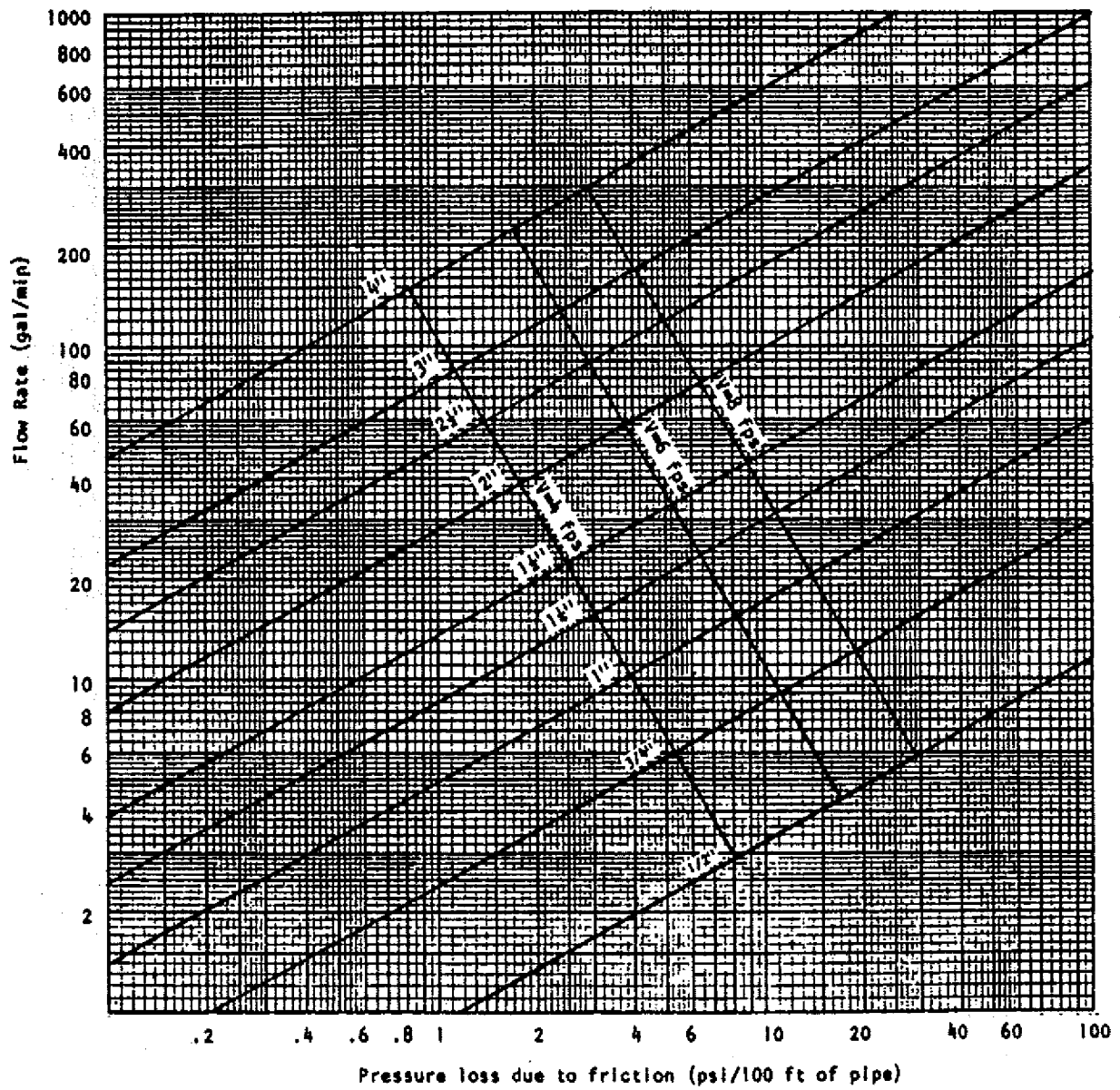

Graph A-82.40 (7)-4

Pressure losses due to flow friction

Material: Galvanized Steel Pipe—Schedule 40, ASTM A53, ASTM A120;
ABS Pipe—Schedule 40; ASTM D1527; or
CPVC Pipe—Schedule 40; ASTM F441; or
PE Pipe—Schedule 40; ASTM D2104; ASTM D2447; or
PVC Pipe—Schedule 40; ASTM D1785; ASTM D2672

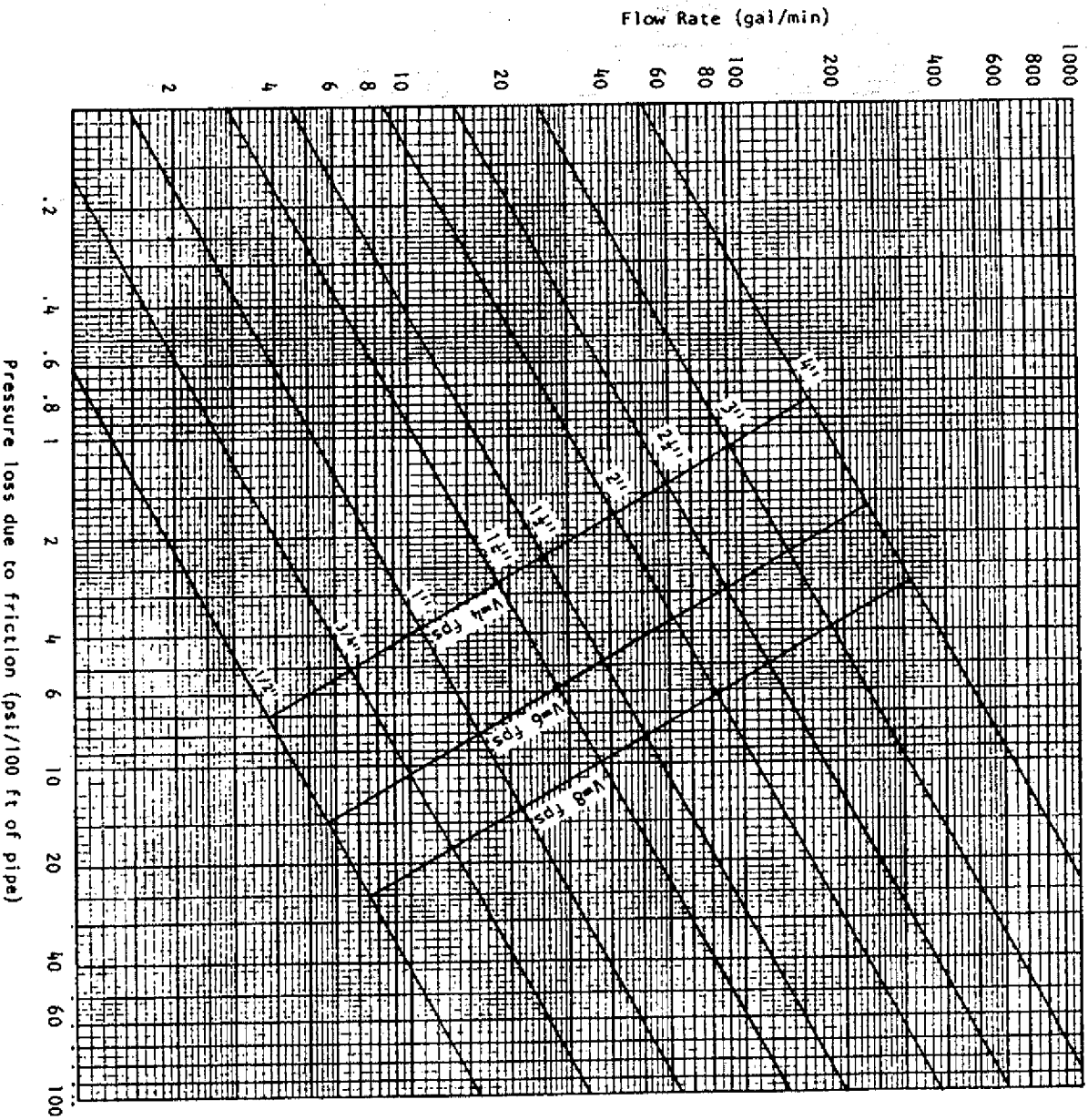

Graph A-82.40 (7)-5

Pressure losses due to flow friction
Material: Polybutylene Tubing, ASTM D3309; or
CPVC Tubing; ASTM D2846

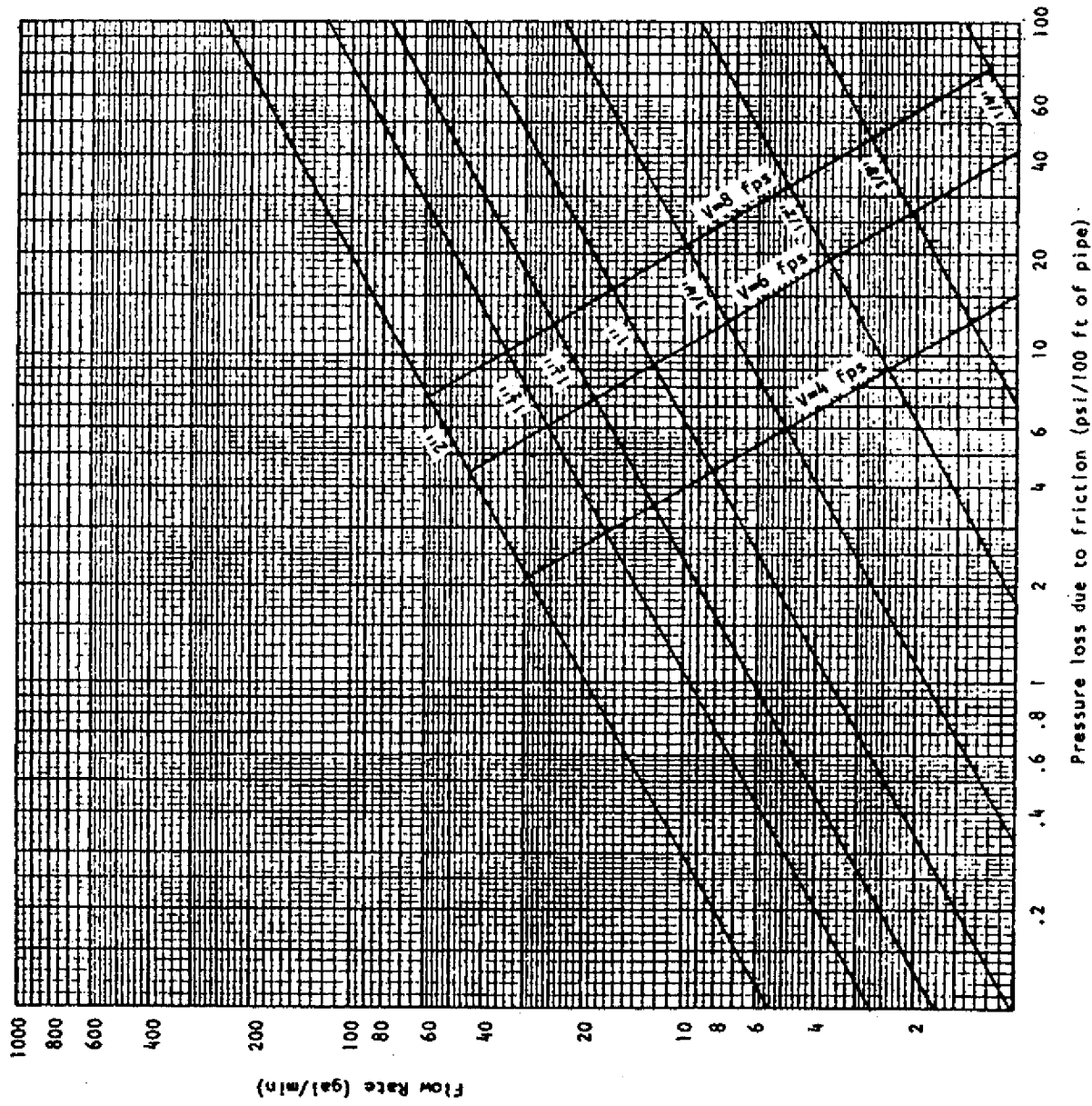

Graph A-82.40 (7)-6
 Pressure losses due to flow friction
 Material: Crosslinked Polyethylene (PEX) Tubing, ASTM F876

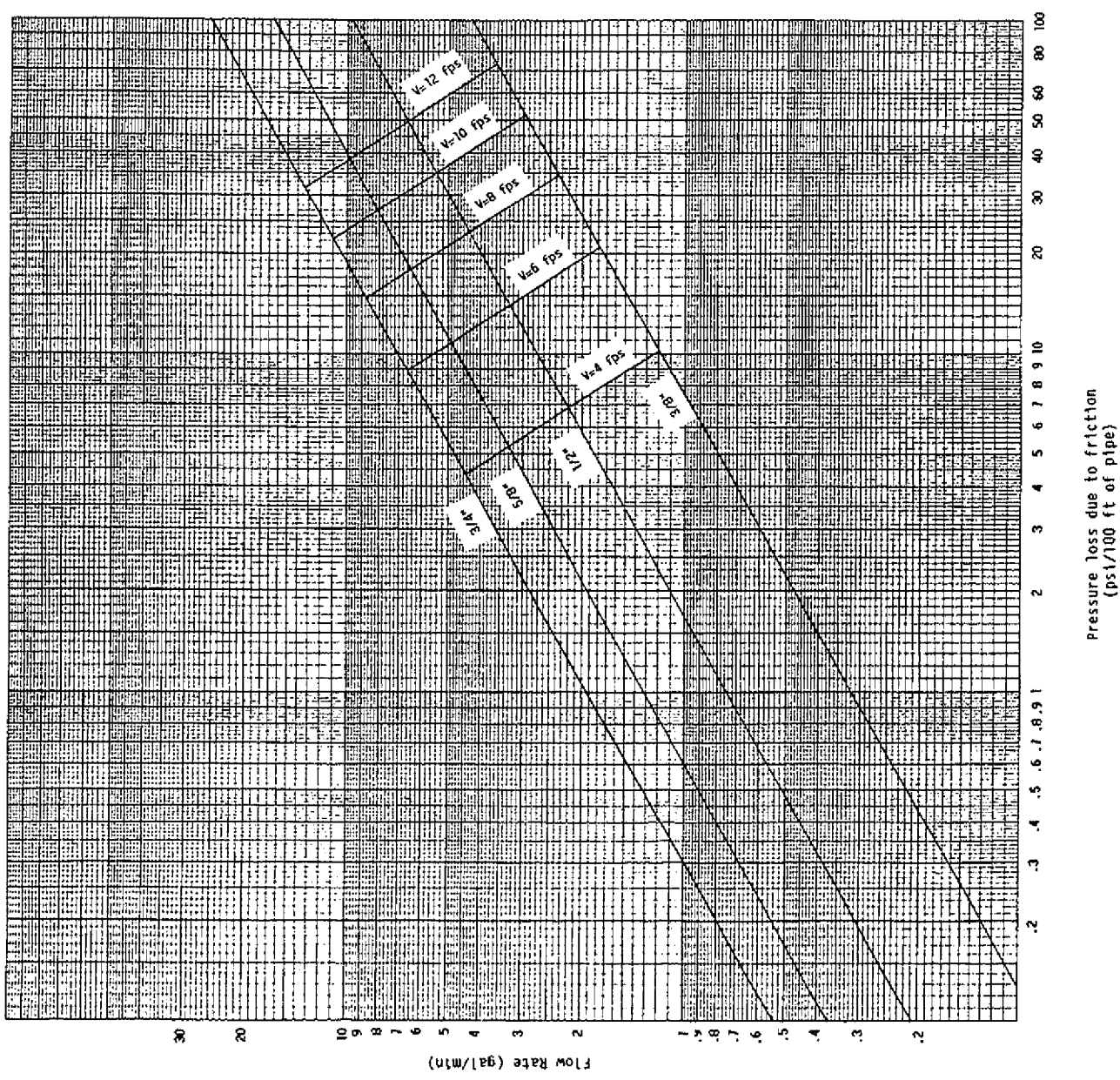

A82.41 (4) (g) 2. TEST OUTLET

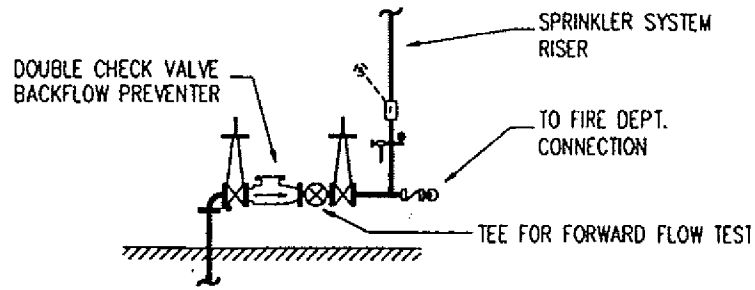

SINGLE WET SYSTEM ARRANGEMENT

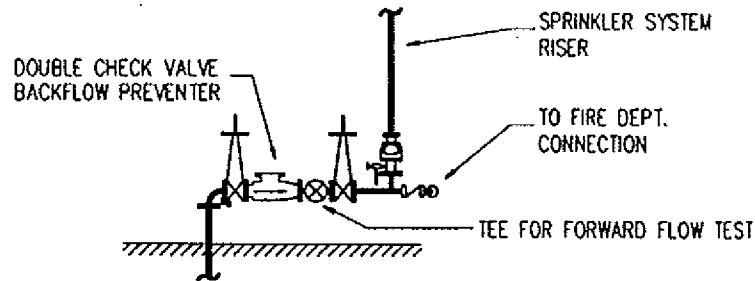

SINGLE DRY SYSTEM ARRANGEMENT

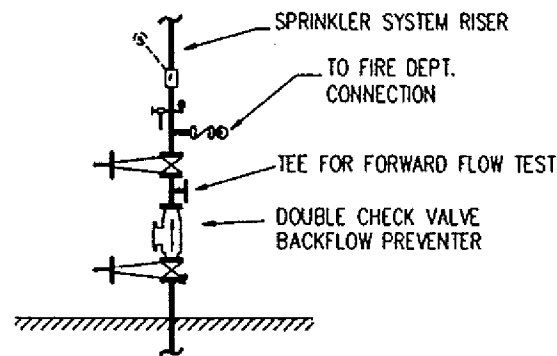

SINGLE WET SYSTEM ARRANGEMENT

A-82.41 (5) (a) AIR GAP

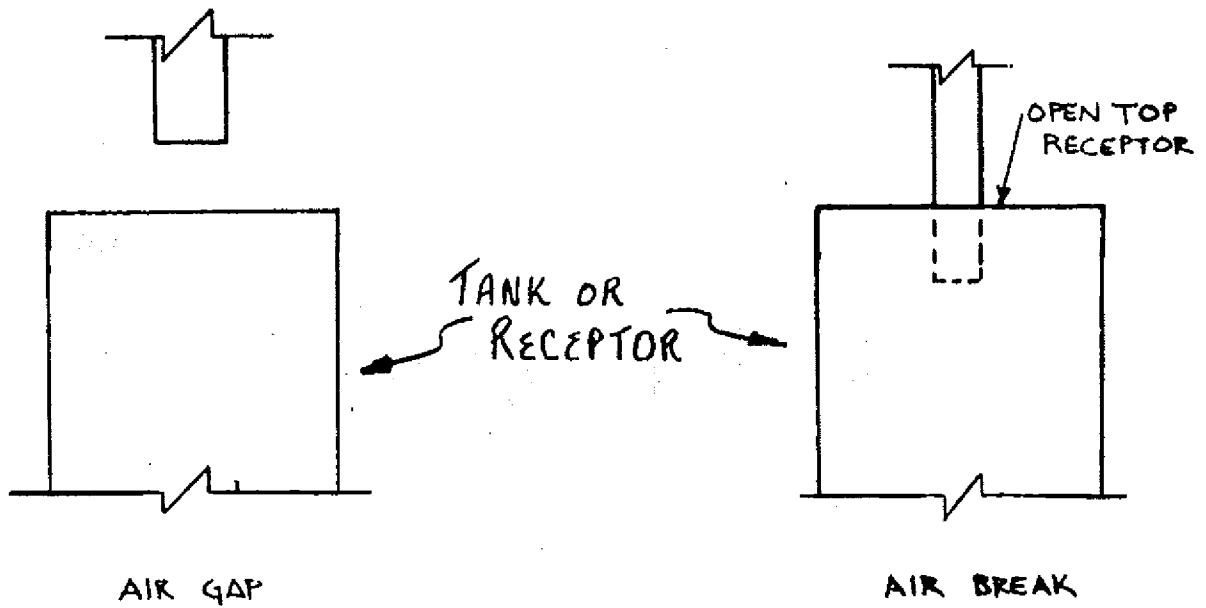

ANSI STANDARD A112.1.2 DESCRIBES OTHER ACCEPTABLE TYPES OF AIR GAPS.

A-82.41 (5) (f) CROSS CONNECTION CONTROL DEVICE INSTALLATION.

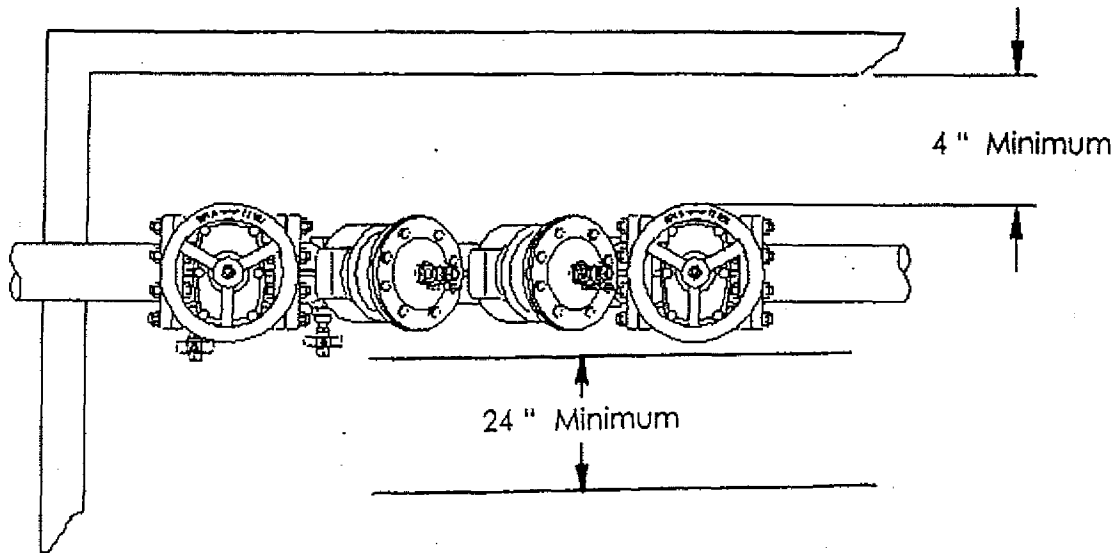

NOTE: ASSEMBLIES SHALL BE INSTALLED IN ACCORDANCE WITH THE MANUFACTURER'S WRITTEN INSTALLATION SPECIFICATIONS OR WITHIN THE DIMENSIONS SHOWN.

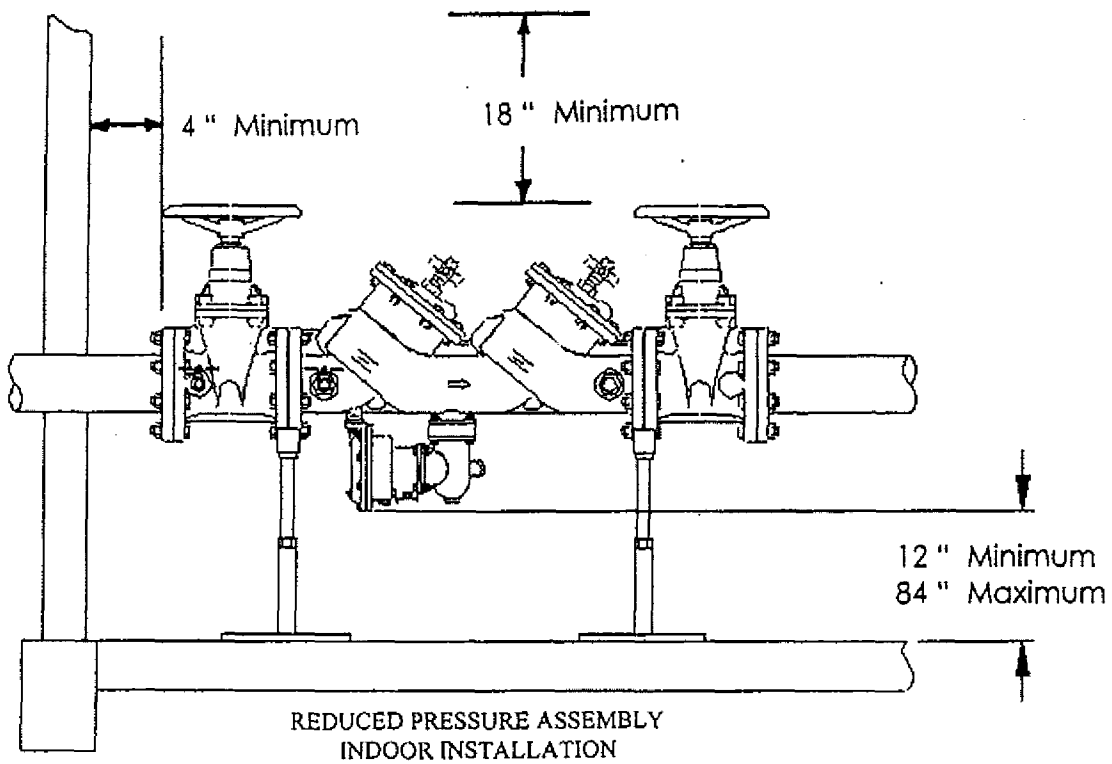

A-82.41 (5) (f) CROSS CONNECTION CONTROL DEVICE INSTALLATION.

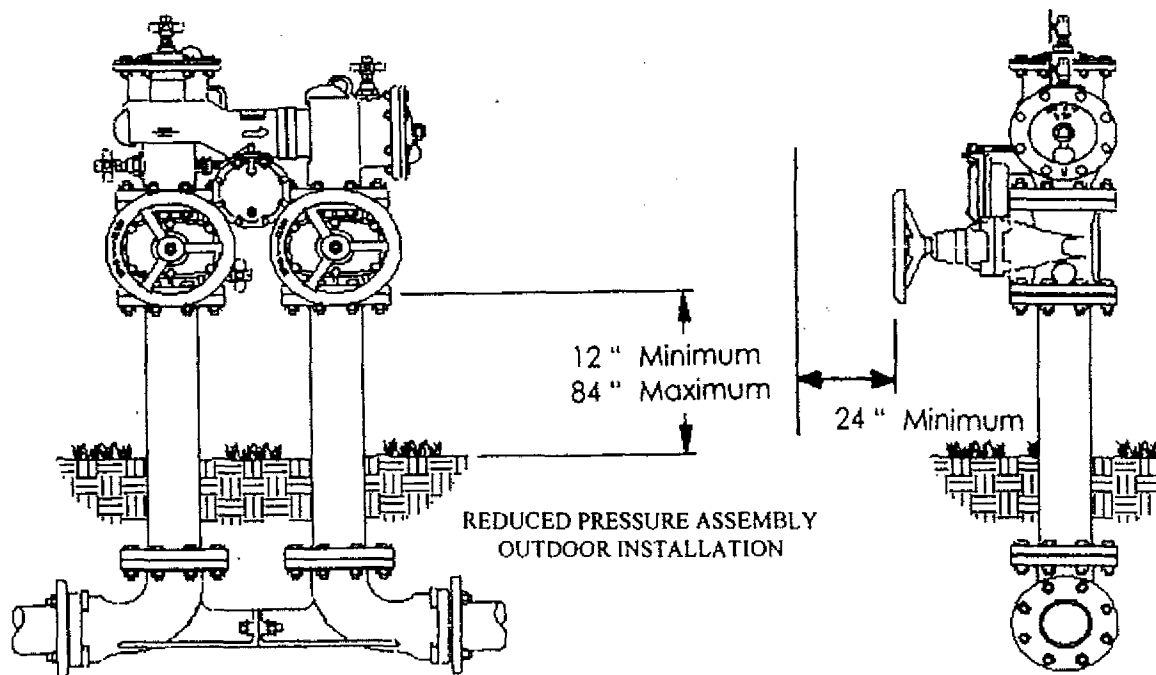
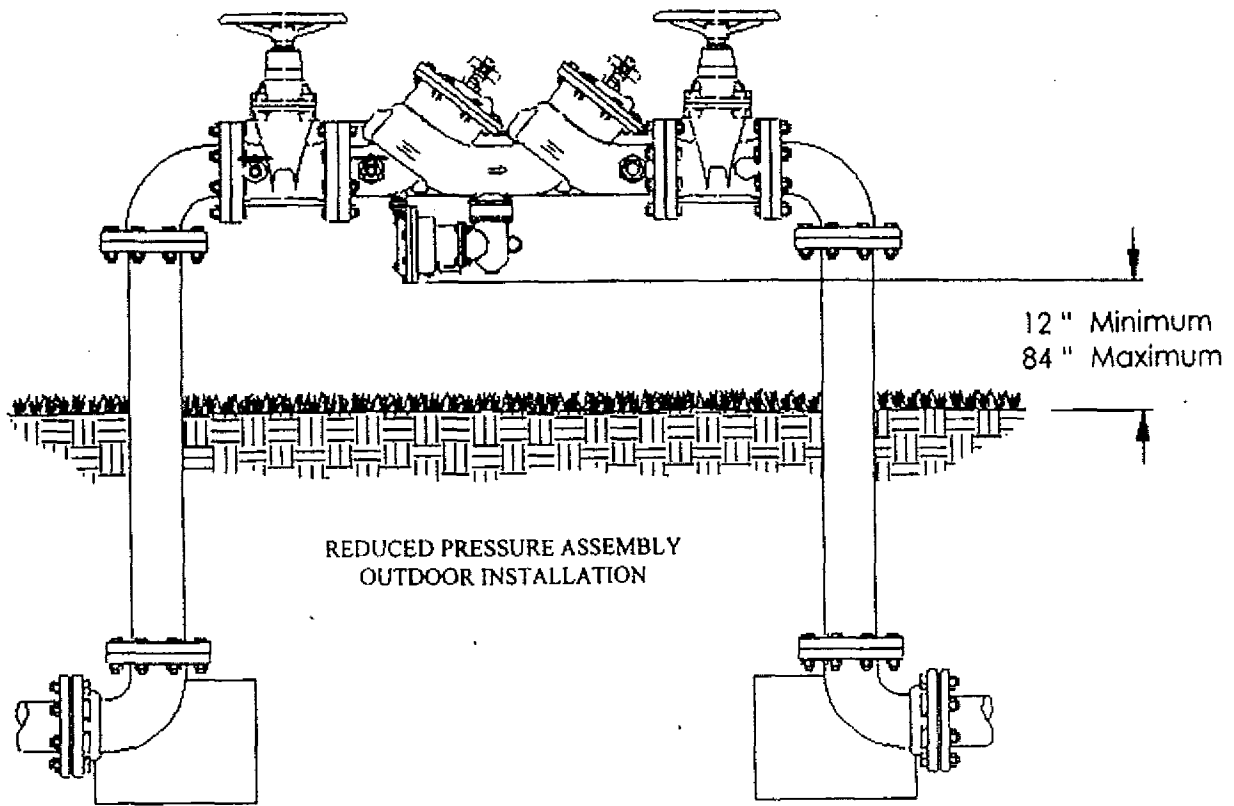

A-82.41 (5) (f) CROSS CONNECTION CONTROL DEVICE INSTALLATION

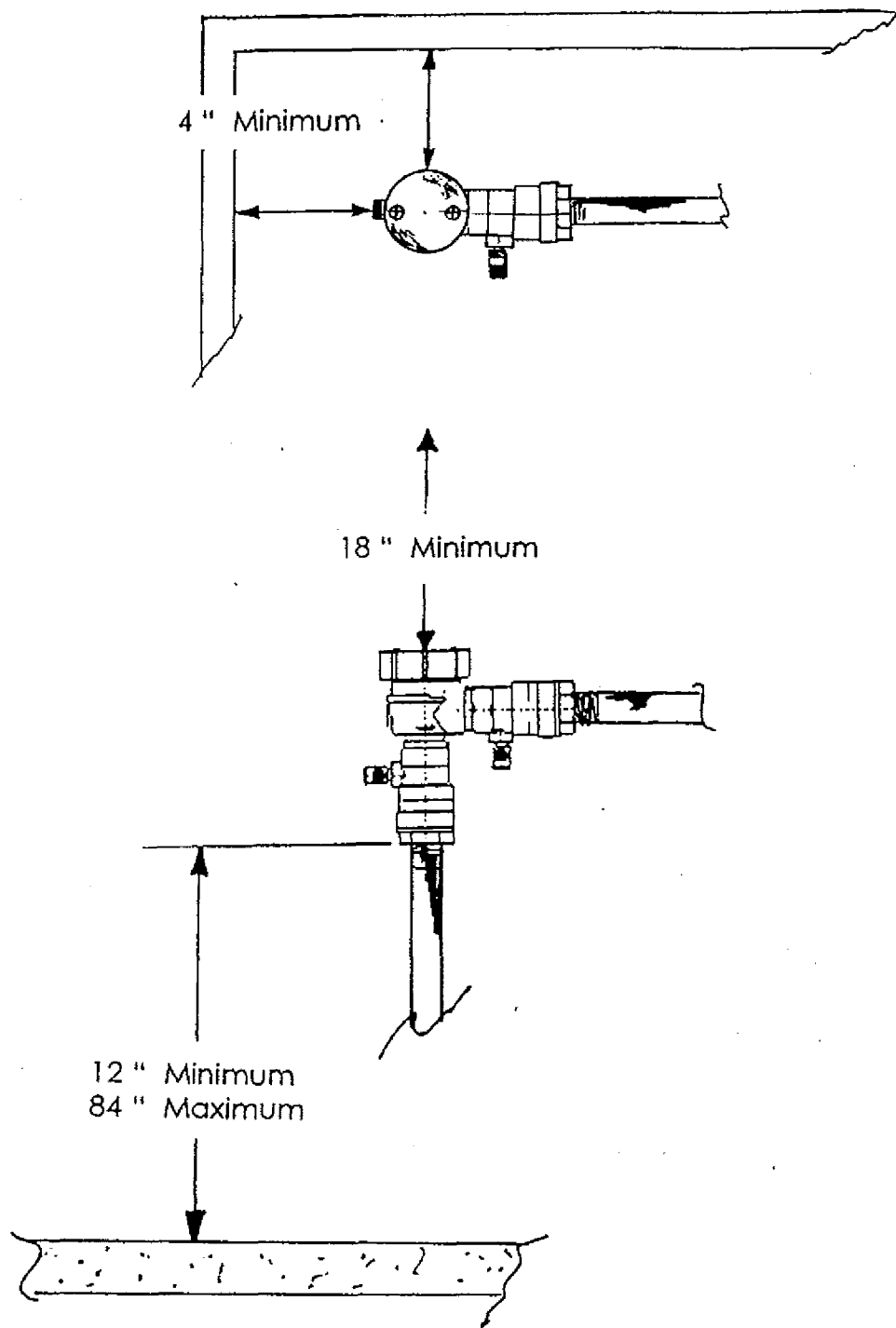

PRESSURE VACUUM BREAKER ASSEMBLY
BACK SIPHONAGE BACKFLOW VACUUM BREAKER

A-82.41 (5) (f) CROSS CONNECTION CONTROL DEVICE INSTALLATION.

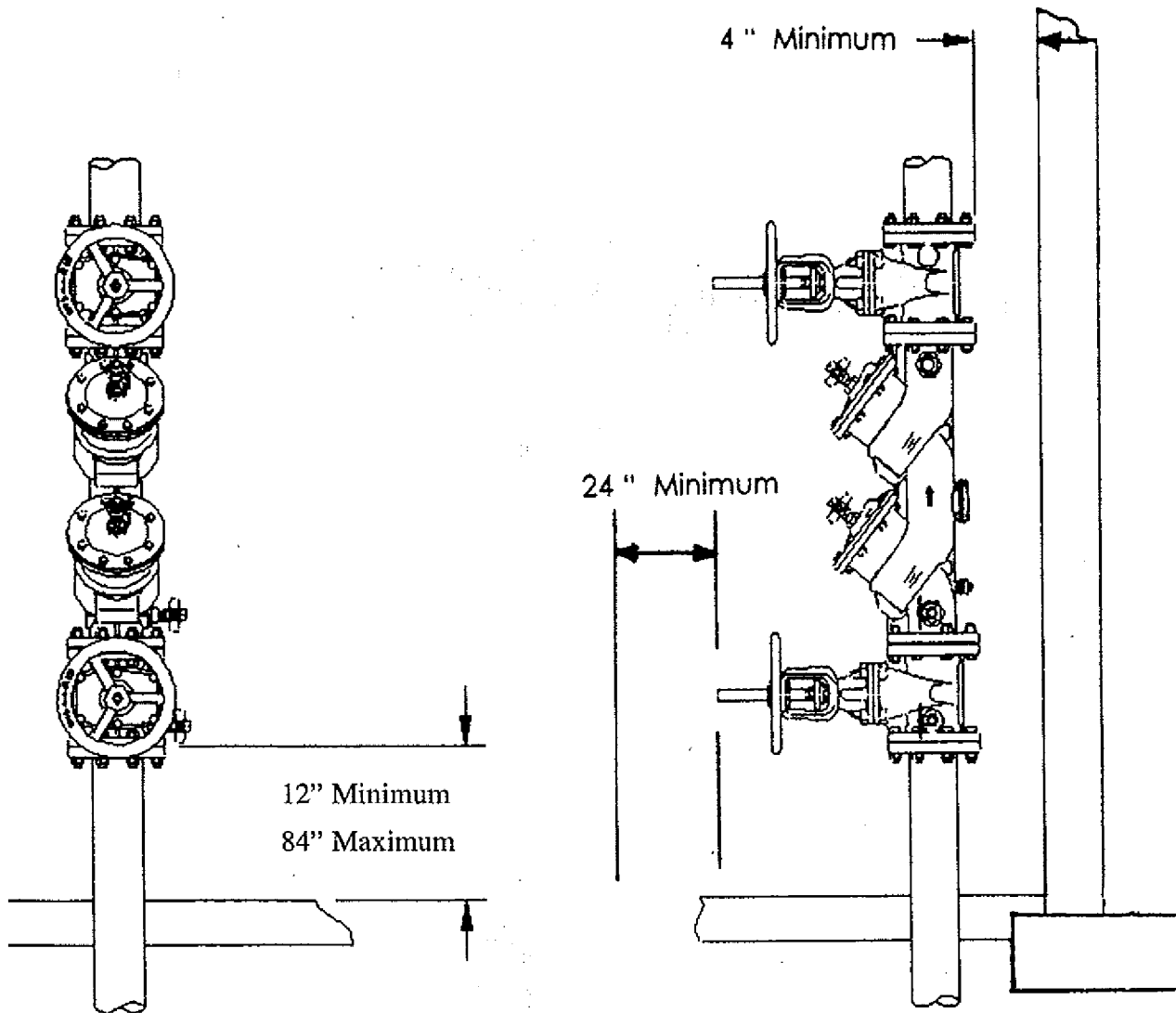

DOUBLE CHECK ASSEMBLY
INDOOR VERTICAL INSTALLATION

A-82.41 (5) (f) CROSS CONNECTION CONTROL DEVICE INSTALLATION.

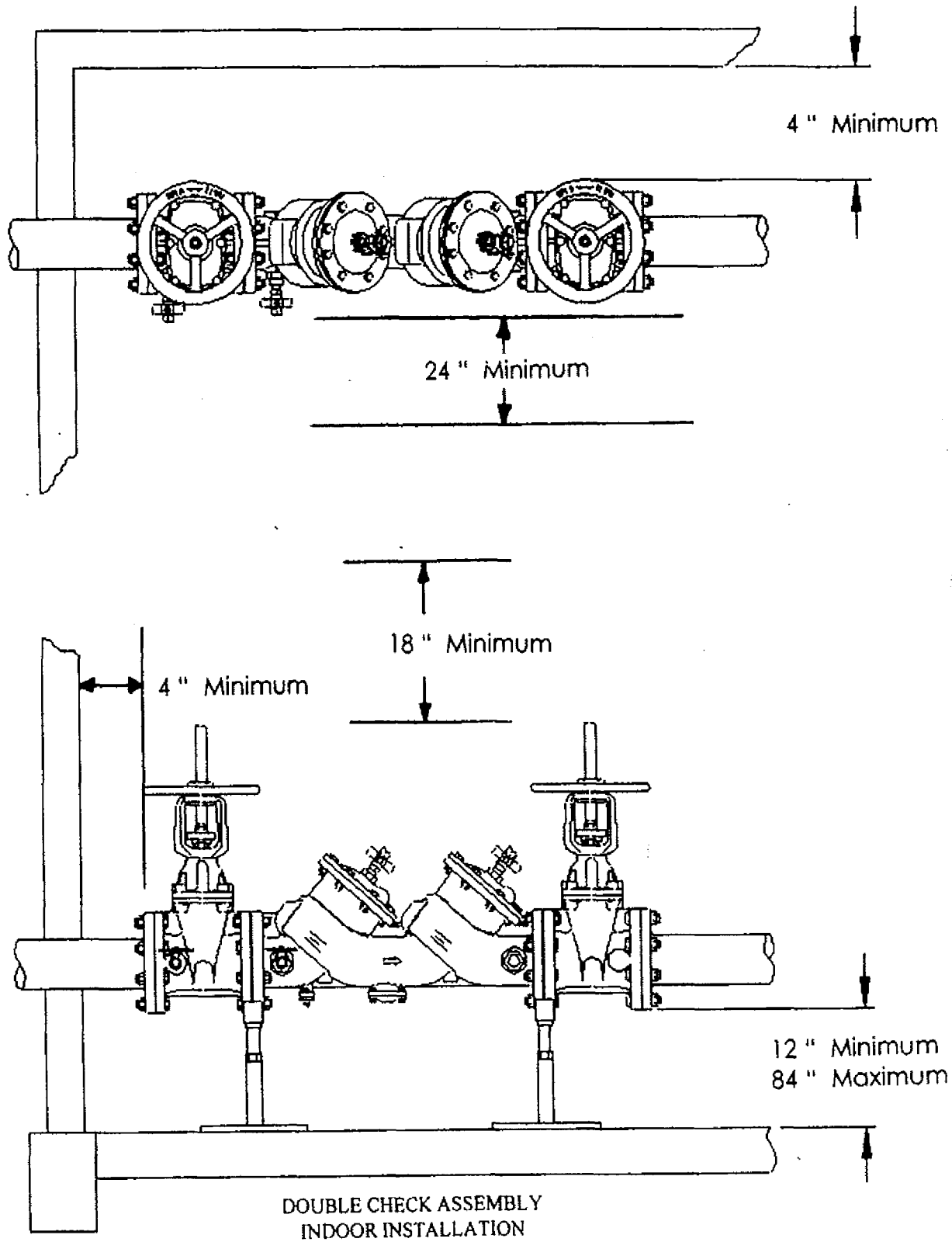

A-82.51 (3) MOBILE HOME SITES AND PARKS.

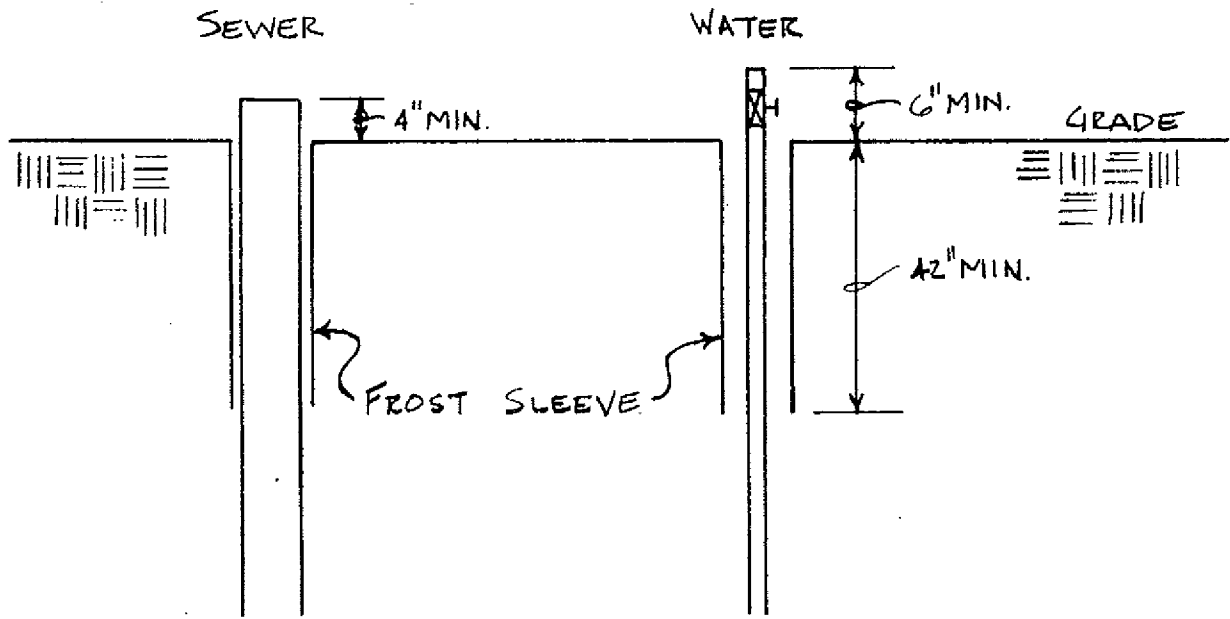

MOBILE HOME BUILDING SEWER AND WATER SERVICE TERMINATIONS

