

ILHR 84**APPENDIX**

The material contained in this appendix is for clarification purposes only. The notes, illustrations, etc., are numbered to correspond to the number of the rule as it appears in the text of the code.

A-84.13 Penetrations of fire resistive assemblies. The following sketches depict possible methods of penetrating fire resistive assemblies with plumbing piping systems. For the current acceptable methods, contact the Bureau of Buildings and Structures, P.O. Box 7969, Madison, Wisconsin 53707.

A-84.13 Penetrations of fire resistive assemblies.

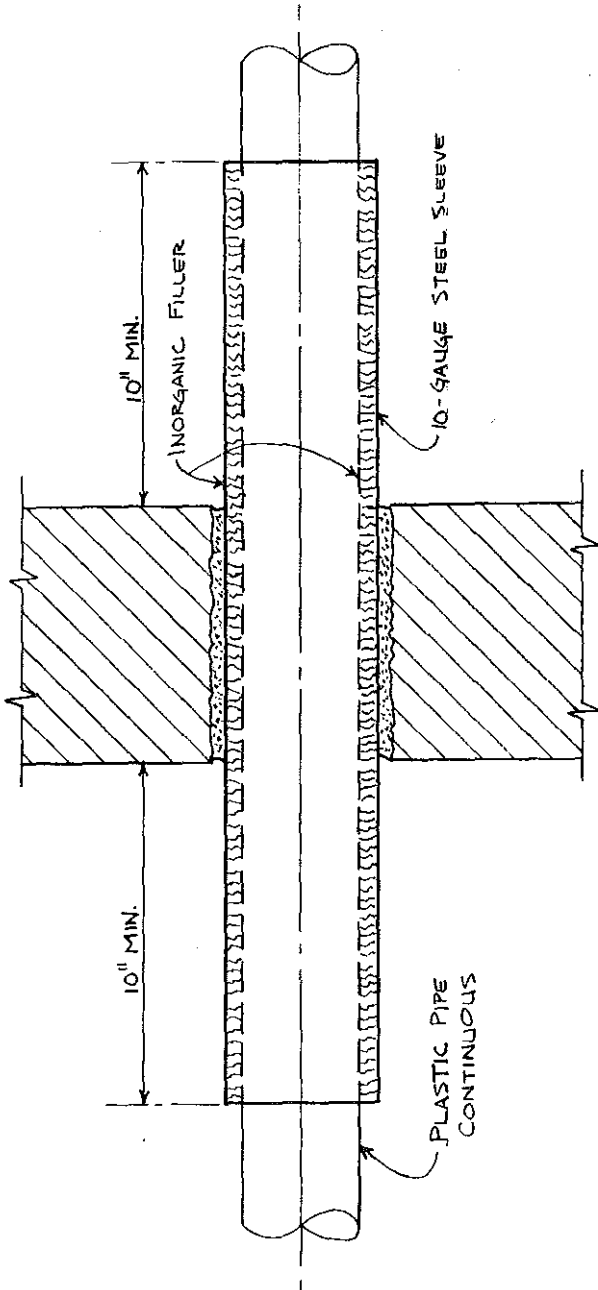

10" GA. SLEEVE ONE INCH DIA. LARGER THAN PIPE

A-84.13 Penetrations of fire resistive assemblies.

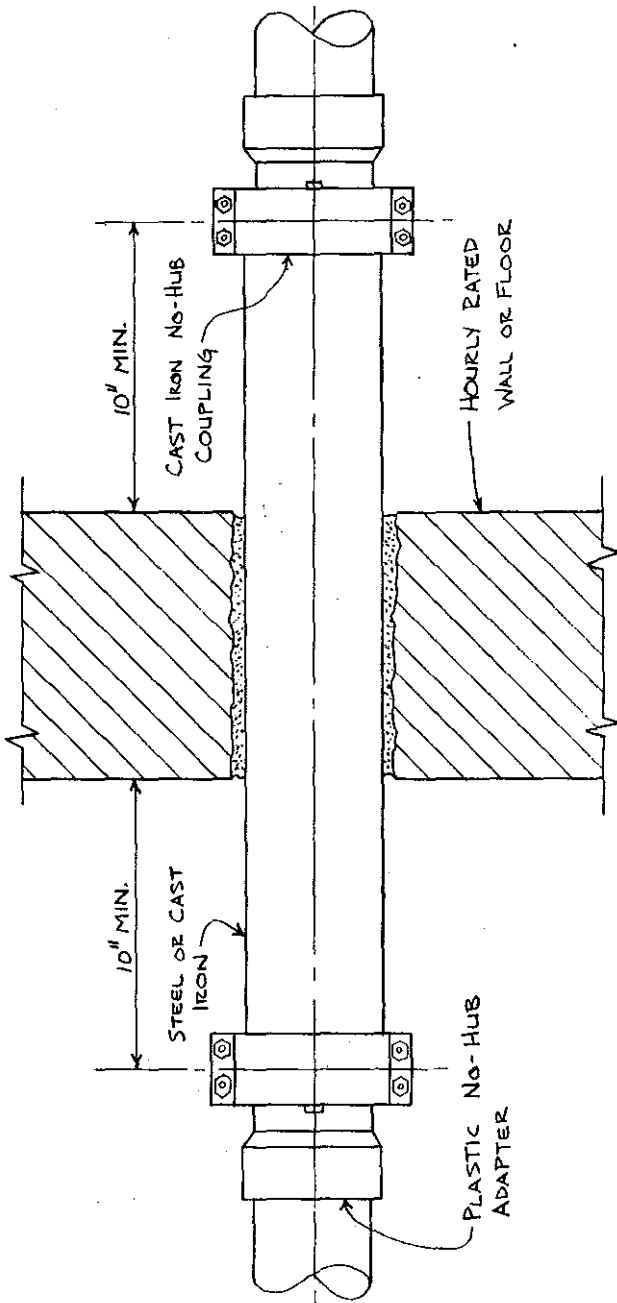

SUBSTITUTION OF CAST IRON OR STEEL PIPE

ILHR 84

A-84.13 Penetrations of fire resistive assemblies.

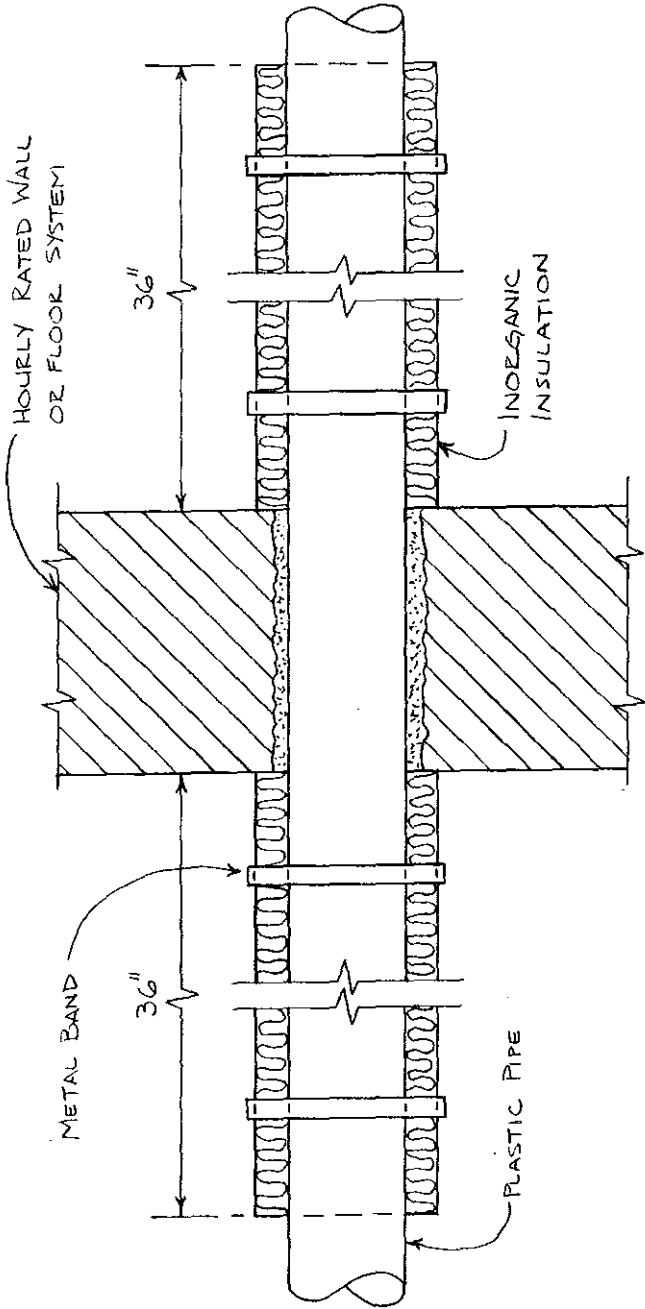

WRAP PLASTIC WITH 1" THICK INSULATION

A-84.13 Penetrations of fire resistive assemblies.

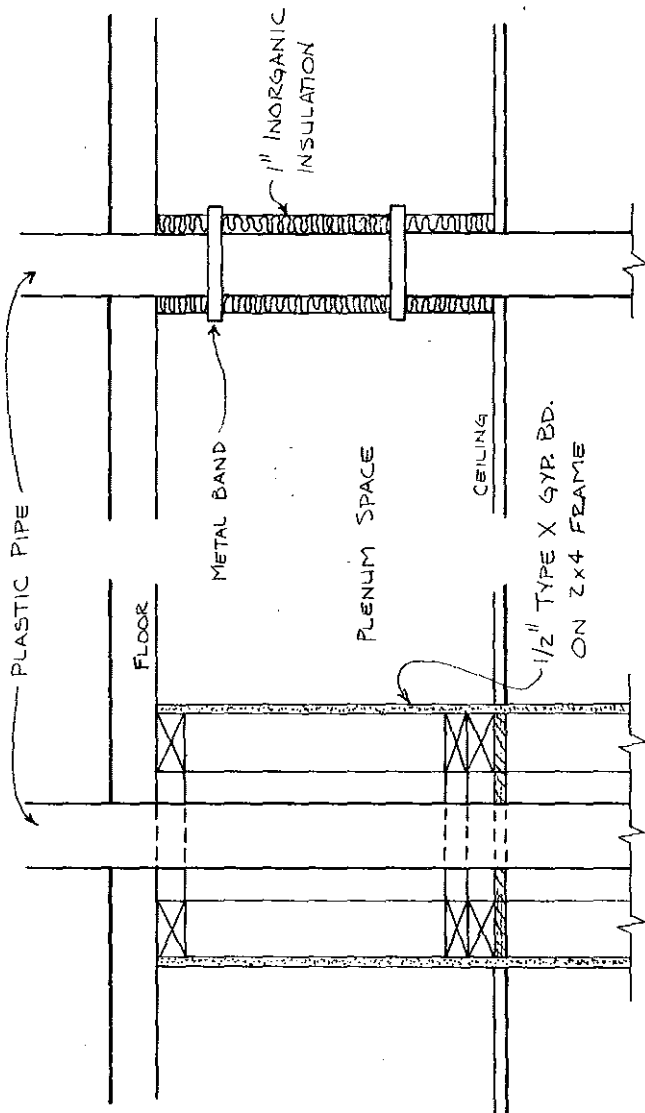

PROTECTION IN PLENUMS

A-84.20 (3) ACCESSIBLE TOILET ROOMS AND SANITARY FACILITIES. The following sketches and diagrams are a reprint from the 1984 edition of the Building and Heating, Ventilating and Air Conditioning, chapters ILHR 50-64. For the current accessibility requirements, contact the Bureau of Buildings, P.O. Box 7969, Madison, Wisconsin 53707.

EXAMPLES OF ACCESSIBLE TOILET COMPARTMENTS
 AS SPECIFIED IN TABLE 62.04-A

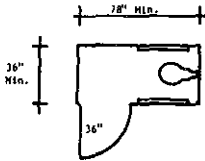

Recommended fixtures:

1. Elongated bowl;
2. Wall mounted.

Note: These are examples of toilet room compartments which are located within accessible toilet rooms.

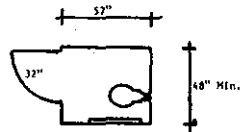
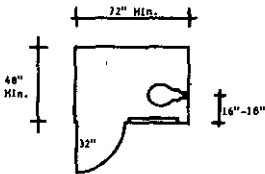
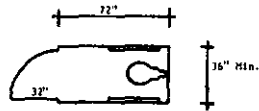
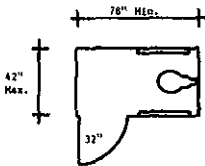

The door of the 48" x 57" water closet compartment having a frontal approach should not align with the placement of the water closet.

EXAMPLES OF ACCESSIBLE TOILET ROOMS
CONTAINING ONE LAVATORY AND ONE WATER CLOSET

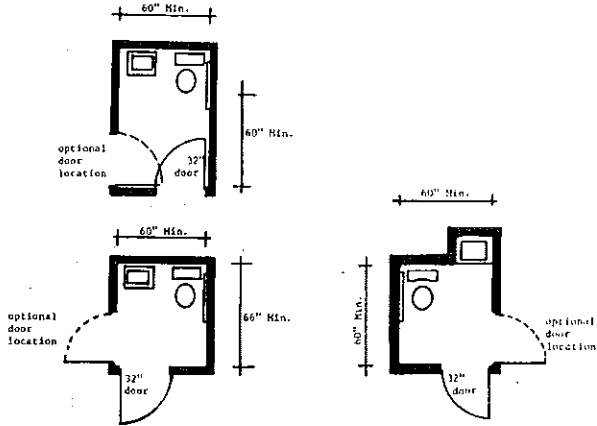

Note #1: These examples of accessible toilet rooms may be used in health care facilities in that sufficient room for the attendant is provided.

Note #2: These examples may be modified by substituting pocket sliding doors for the swing doors shown in the examples. Surface-mounted hardware is recommended for pocket sliding doors.

EXAMPLES OF ACCESSIBLE BATHROOM LAYOUTS
FOR RESIDENTIAL LIVING UNITS

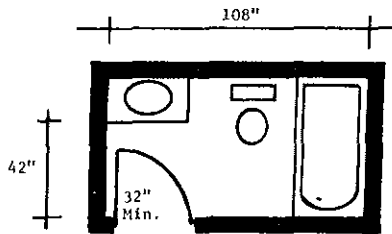
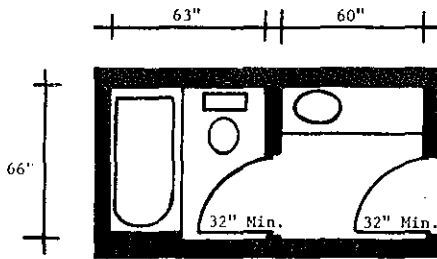
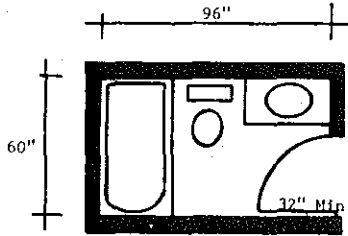

EXAMPLES OF ACCESSIBLE TOILET ROOMS

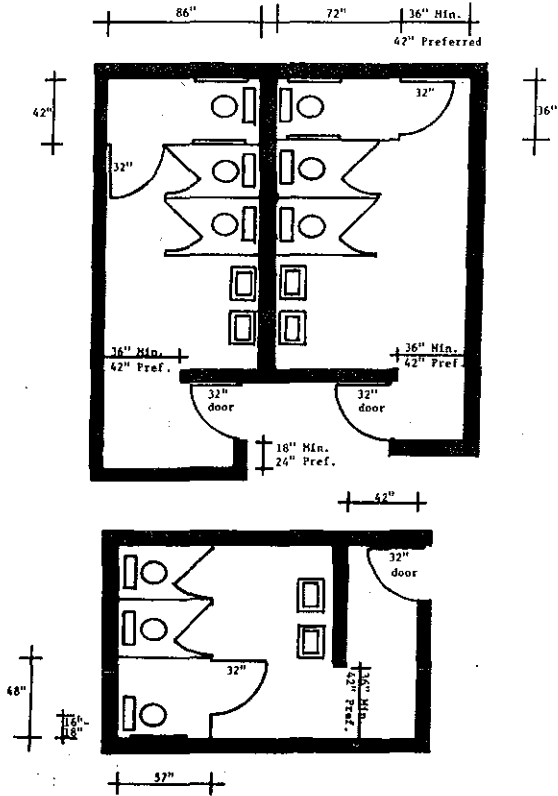

ACCESSIBLE TOILET ROOMS

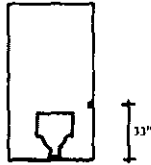

It is recommended that grab bars be from 30 to 42 inches in length and located no more than 12 inches from the back wall.

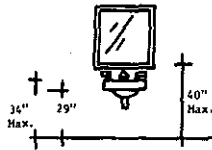
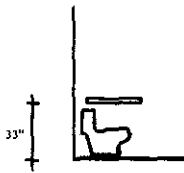

ACCESSIBLE BATHING FACILITIES

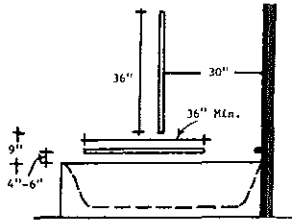

Side Elevation - Bathtub

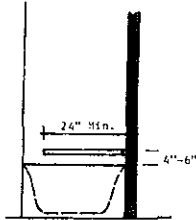

End Elevation - Bathtub

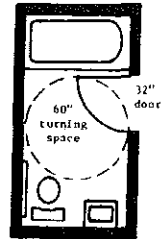
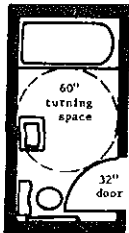

These diagrams are examples of accessible bathrooms which may be used for motels, hotels, hospitals and nursing homes.

ACCESSIBLE BATHING FACILITIES

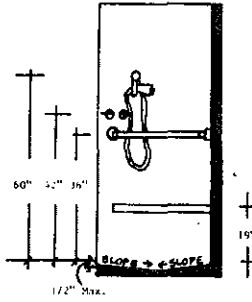

Section View - Shower

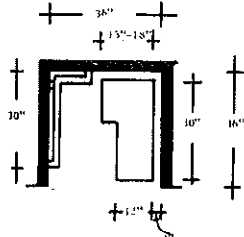

Plan View - Shower

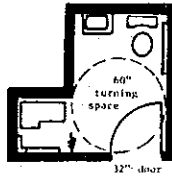

EXAMPLES OF ADAPTABLE BATHROOM LAYOUTS
FOR RESIDENTIAL LIVING UNITS
(not including hotels and motels)

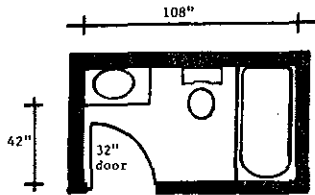
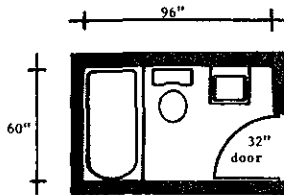

These examples may be modified for accessibility by using outward swinging doors or pocket sliding doors.

EXAMPLES OF ACCESSIBLE WATER COOLERS

Note: Conventional floor-mounted water coolers can be serviceable to patrons with functional limitations if a small fountain is mounted on the side of the cooler 30 inches above the floor. Fully recessed water fountains are not recommended and should not be recessed in an alcove unless the alcove is wider than the wheelchair.

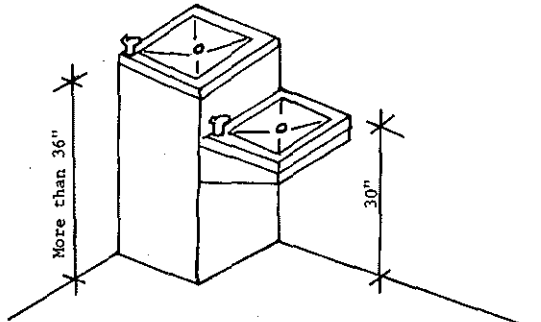
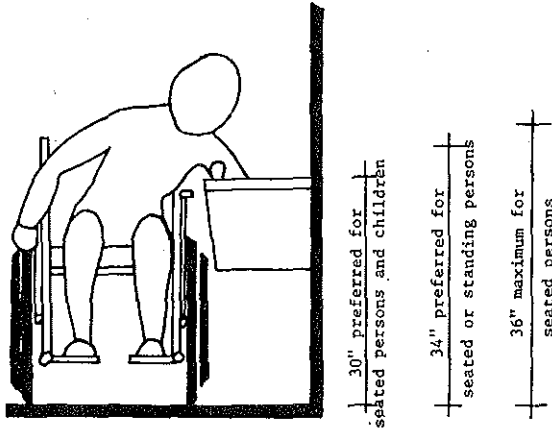

Floor-mounted water cooler with side-mounted cooler

A-84.20 (4) Spacing of plumbing fixtures.

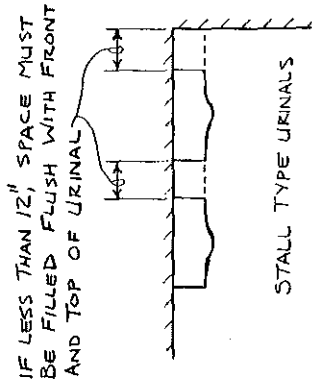
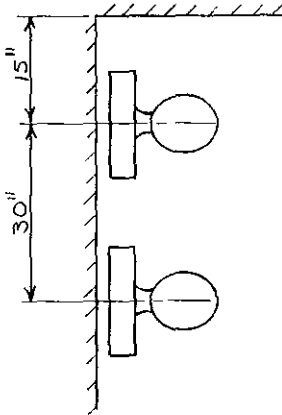

STALL TYPE URINALS

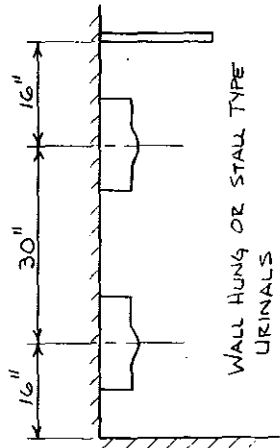
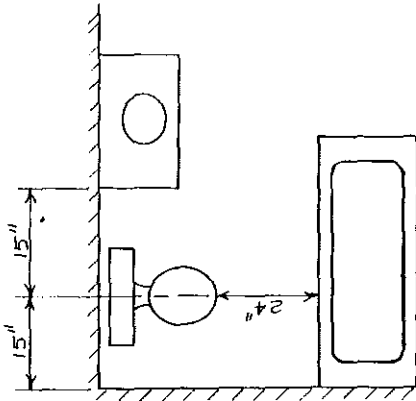

WALL HUNG OR STALL TYPE URINALS

A-84.20 (4) Minimum size of shower compartments.

